



ARES MSR-004



Airsoft Gun Instruction Manual • Always read through this manual before operation

SAFETY

- DO NOT MODIFY OR ALTER YOUR AIRSOFT GUN. Attempts to modify the airsoft gun in way may make your airsoft gun unsafe to use, cause serious injury or death and will void the warranty.
- Always check to see if the airsoft gun is "ON SAFE" and unloaded when getting it from another person or from storage.
- Always keep the airsoft gun "ON SAFE" until you are ready to shoot in a SAFE DIRECTION.
- Misuse or careless use may cause serious injury.
- Do not look into the gun muzzle.
- Do not ever point the airsoft gun at anything you do not intend to shoot.
- You and other with you should always wear shooting glasses to protect your eyes.
- If your reading or prescription glasses are not safety glasses, make sure you wear shooting glasses over your regular glasses.
- Do not put the airsoft gun away loaded. Make sure ALL of the plastic BBs are unloaded from the airsoft gun.
- Do not shoot at hard surfaces or at the surface of water. The plastic BBs may bounce off or ricochet and hit someone or something you had not intended to hit. If the plastic BBs should happen to hit a hard surface, do not reuse those plastic BBs because they could cause possible damage to your airsoft gun.
- Use 6 mm plastic BBs only.
- Always put the airsoft gun in a case or bag when you carrying it.
- Always store this airsoft gun in a secure location and at the places out of reach by children.
- Always treat the airsoft gun as though it is loaded and with the same respect you would a firearm.
- Using unauthorized repair centers or modifying the function of your airsoft gun in any way may be unsafe and will void your warranty.
- We are not responsible for any malfunction, accidents, injuries or repair cost resulting from misuse, or by disassembly and modification of the airsoft gun.



FIRING MODE

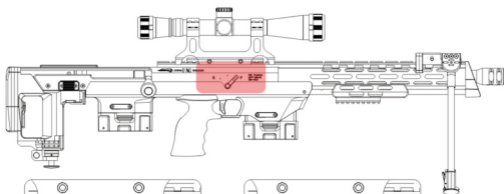

FIRING POSITION

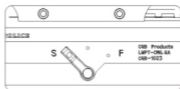

SAFETY POSITION

SETTING THE MAGAZINE

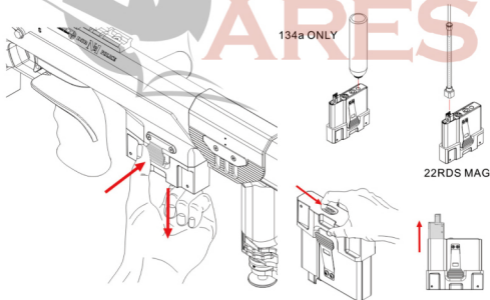

134a ONLY

22RDS MAG

REMOVABLE MAG. STRIP

BUTT STOCK ADJUSTMENT

BUTT STOCK EXTEND

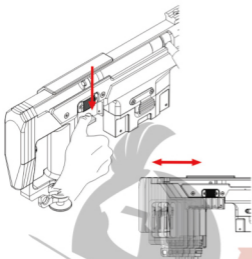

CHEEK PAD ADJUSTMENT

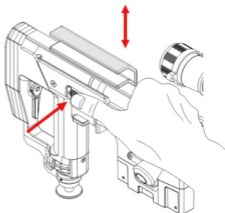

ADJUSTABLE FORE-END

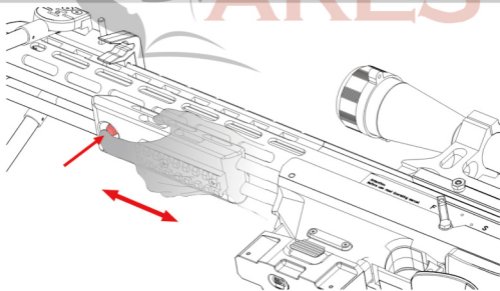

ARES

THE REPLACEMENT PARTS WILL BE AVAILABLE AT OURS LOCAL DISTRIBUTOR AND DEALERS

ADJUSTABLE BIPOD

UNIVERSO SNIPER
AIRSOFT

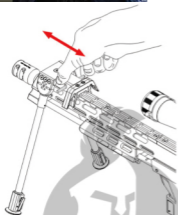
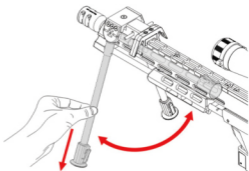

ARES

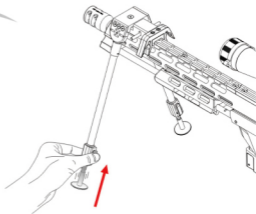
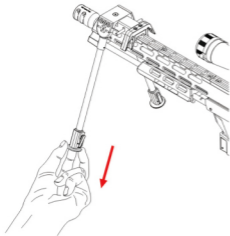

HOP-UP ADJUSTMENT

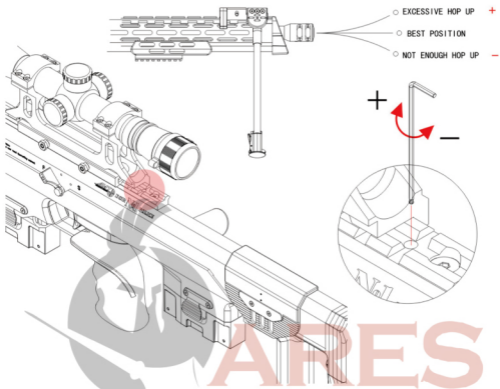

ERGONOMICS OF THE BUTT STOCK

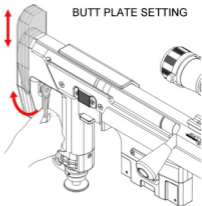
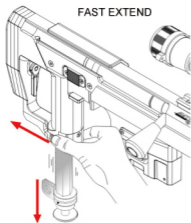

FOR MORE DETAIL INFORMATION PLEASE VISIT OUR WEBSITE

ERGONOMICS OF THE BUTT STOCK

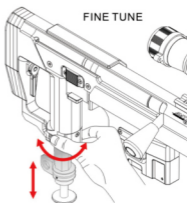
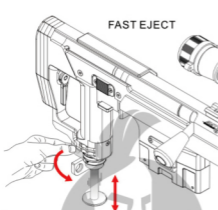

DATA OF MSR-004 GAS GUN

MSR-004



FEATURES

- Folding Bipod
- Adjustable Fore-end
- Ergonomics Of The Butt Stock
- Adjustable Cheek Piece
- Easy Upgrade Power
- Lincenced Marking

GAS POWER:	134a Standard (Optional CO2 Magazine)
MAGAZINE CAPACITY:	23rds (6mm BB)
MODE:	Bolt Action Single
MATERIAL:	Nylon Fiber + Al.Alloy
HOP-UP:	Match Grade Adjustable
LENGTH:	960-1005mm
WEIGHT:	6400g
VELOCITY:	350-380FP



Manufacturer & Brand Owner : Forever Good (Hong Kong) Ltd.



SHOOTER



Worldwide:

Ares Website: <http://www.aresairsoft.com>

General Enquiries: ares@aresairsoft.com

North America: ZShot

Exclusive Distributor - <http://www.ZShot.com>

Dealer Inquires: Sales@ZShot.com Technical Support: Support@ZShot.com

ARES MSR-004

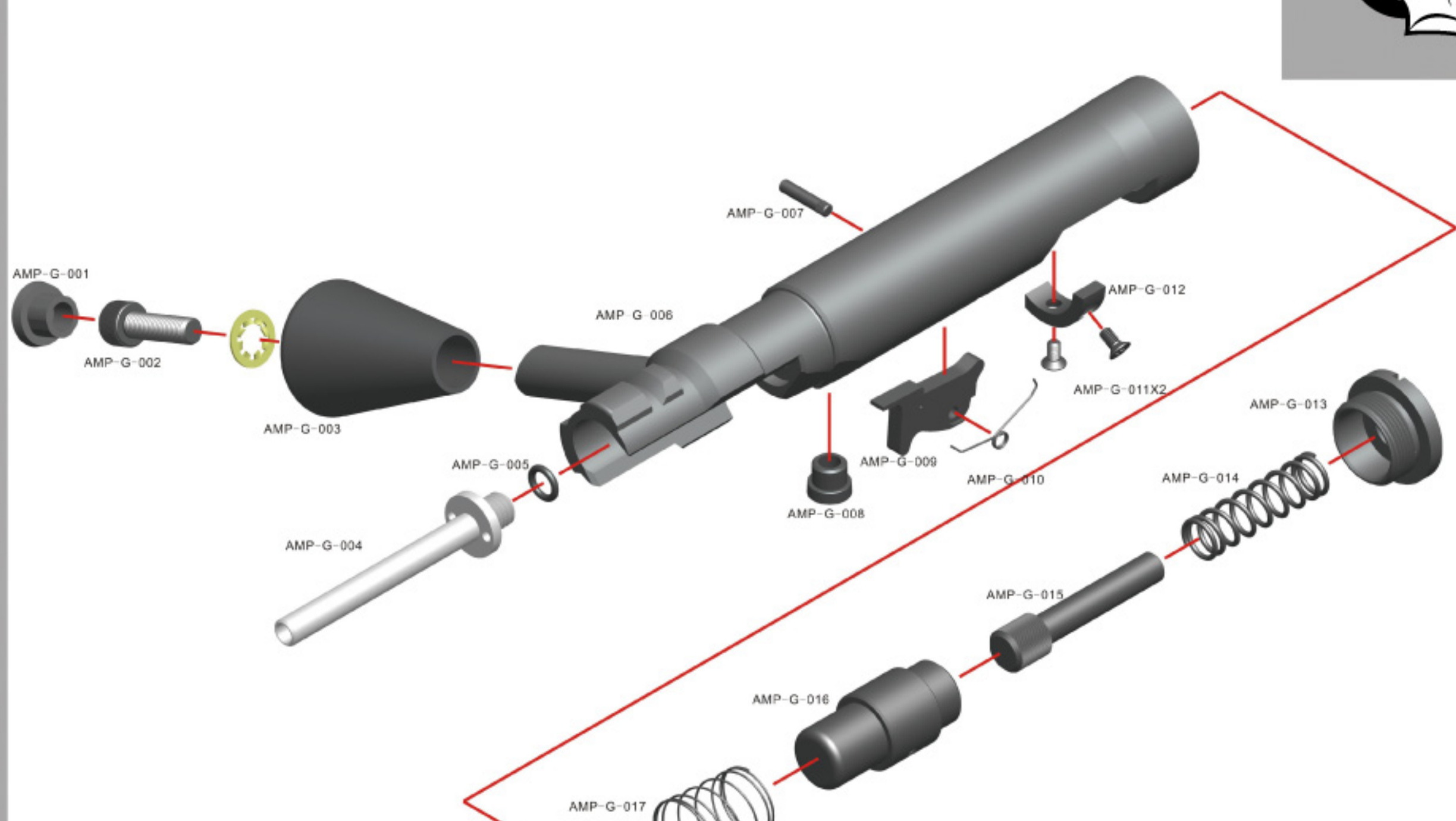
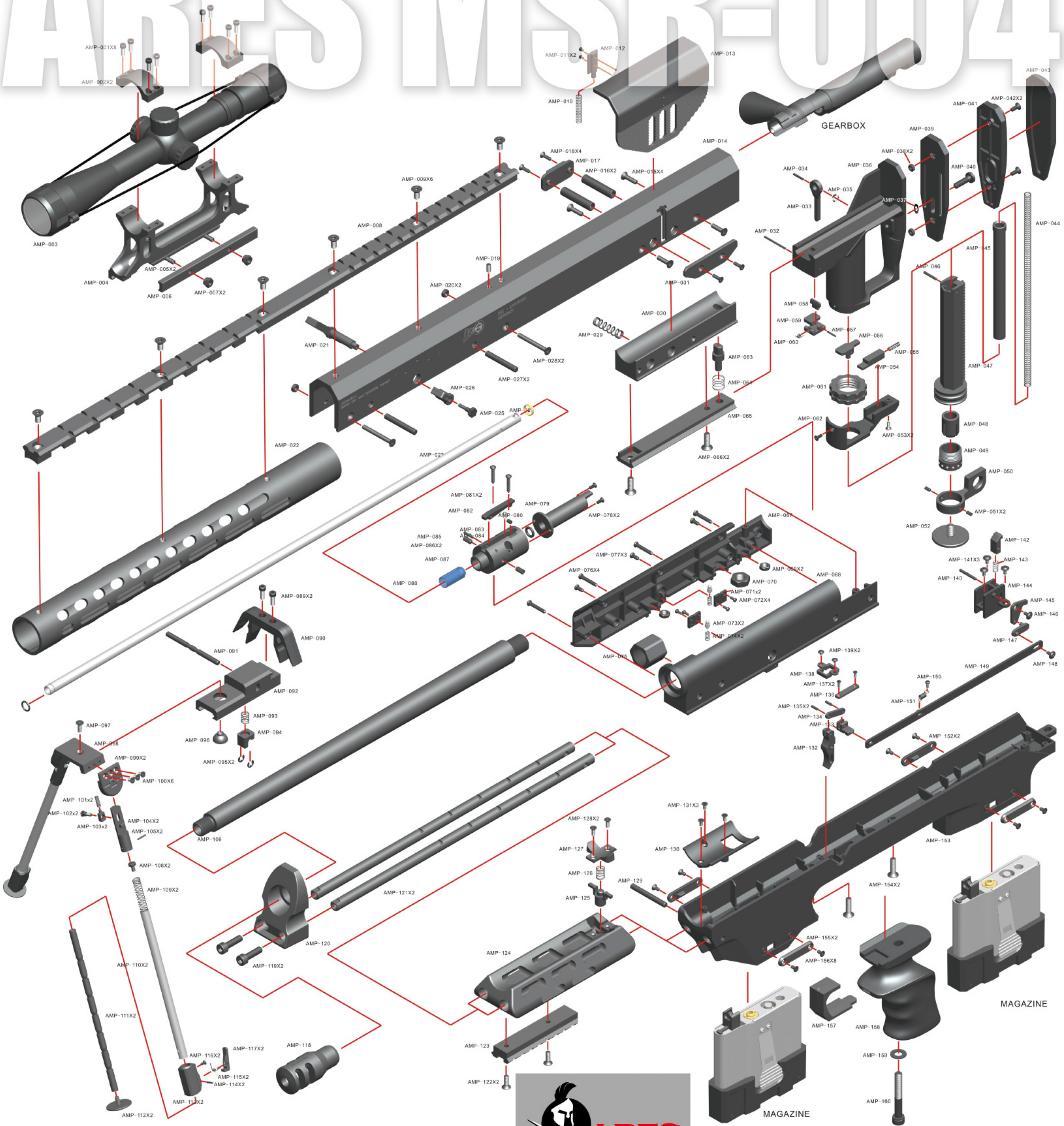

GEAR BOX

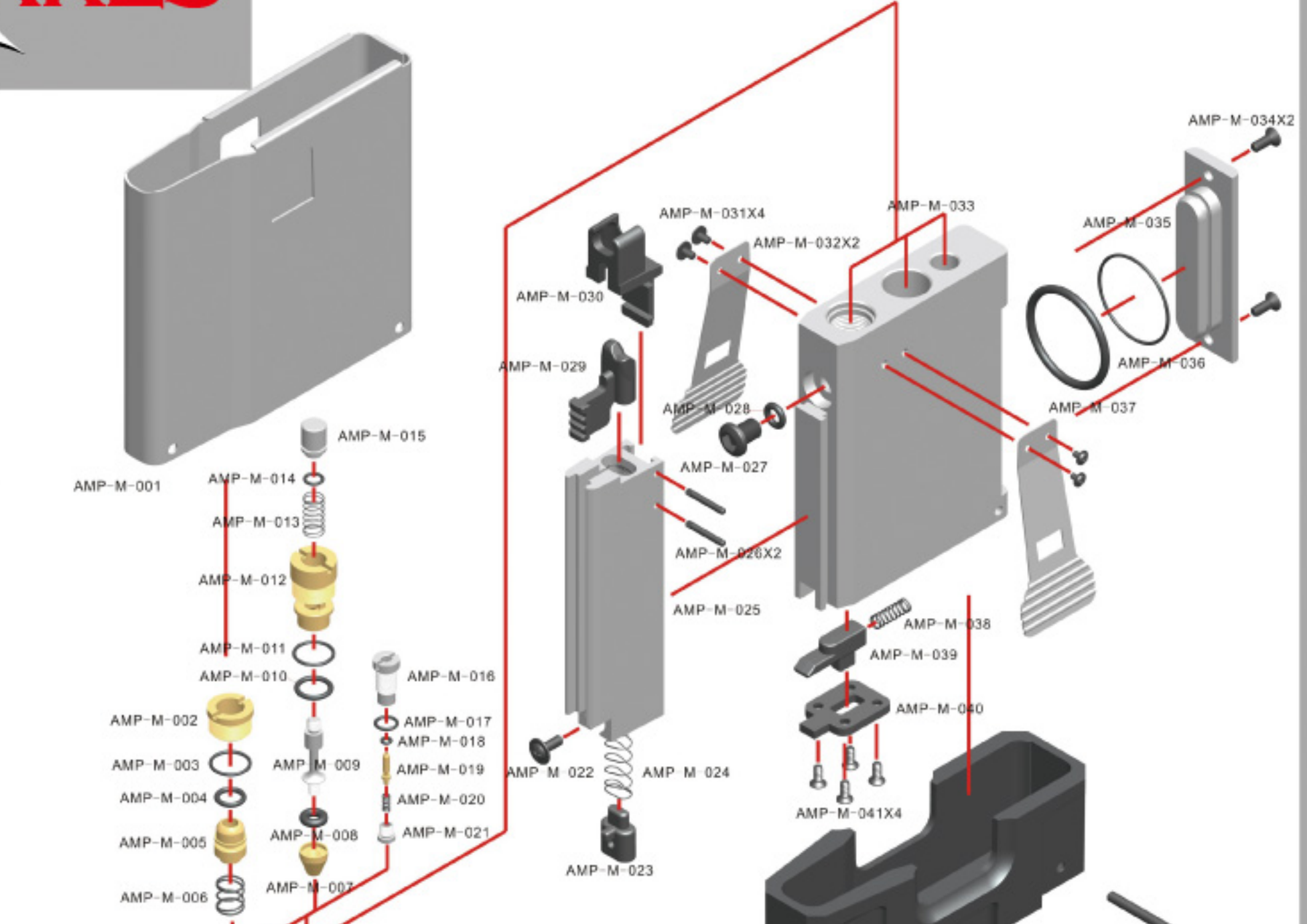

MAGAZINE