

ARES AR-002



UNIVERSO SNIPER
AIRSOFT



Automatic Electric Airsoft Gun Instruction Manual • Always read through this manual before operation

SAFETY

- DO NOT MODIFY OR ALTER YOUR AIRSOFT GUN. Attempts to modify the airsoft gun in way may make your airsoft gun unsafe to use, cause serious injury or death and will void the warranty.
- Always check to see if the airsoft gun is "ON SAFE" and unloaded when getting it from another person or from storage.
- Always keep the airsoft gun "ON SAFE" until you are ready to shoot in a SAFE DIRECTION.
- Misuse or careless use may cause serious injury.
- Do not look into the gun muzzle.
- Do not ever point the airsoft gun at anything you do not intend to shoot.
- You and other with you should always wear shooting glasses to protect your eyes.
- If your reading or prescription glasses are not safety glasses, make sure you wear shooting glasses over your regular glasses.
- Do not put the airsoft gun away loaded. Make sure ALL of the plastic BBs are unloaded from the airsoft gun.
- Do not shoot at hard surfaces or at the surface of water. The plastic BBs may bounce off or ricochet and hit someone or something you had not intended to hit. If the plastic BBs should happen to hit a hard surface, do not reuse those plastic BBs because they could cause possible damage to your airsoft gun.
- Use 6 mm plastic BBs only.
- Always put the airsoft gun in a case or bag when you carrying it.
- Always store this airsoft gun in a secure location and at the places out of reach by children.
- Always treat the airsoft gun as though it is loaded and with the same respect you would a firearm.
- Using unauthorized repair centers or modifying the function of your airsoft gun in any way may be unsafe and will void your warranty.
- We are not responsible for any malfunction, accidents, injuries or repair cost resulting from misuse, or by disassembly and modification of the airsoft gun.



OPTIONAL ACCESSORIES

FULL METAL 4X SUSAT

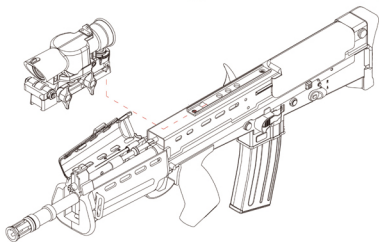
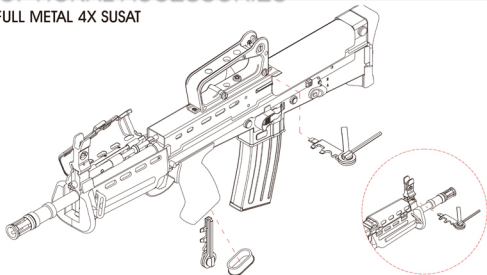

Susat adjustment:

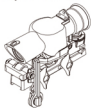

Loose the nut

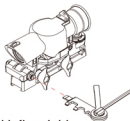

Adjust left or right

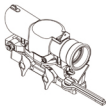

Adjust up or down

INSERT THE BATTERY

Use the specified battery for your gun.
8.4V 1700mAh

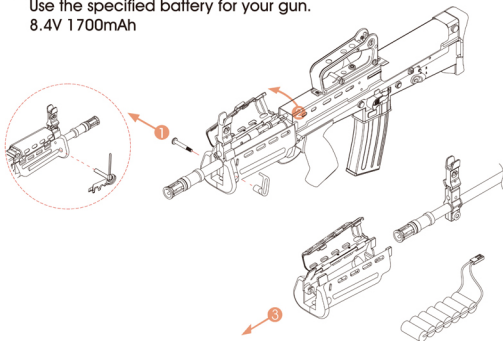

SETTING THE MAGAZINE

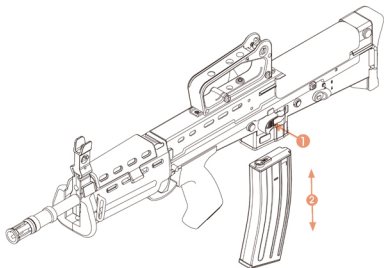

THE REPLACEMENT PARTS WILL BE AVAILABLE AT OURS LOCAL DISTRIBUTOR AND DEALERS

FIRING MODE

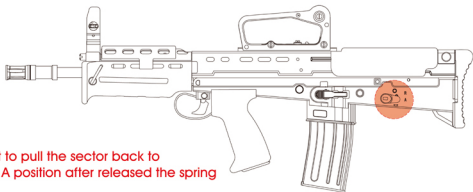
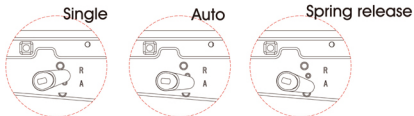

HOP-UP ADJUSTMENT

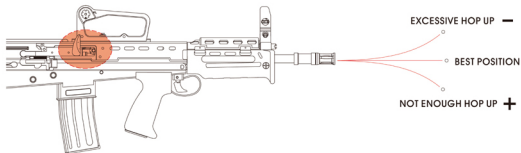
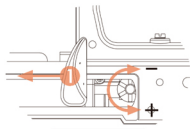

SAFETY

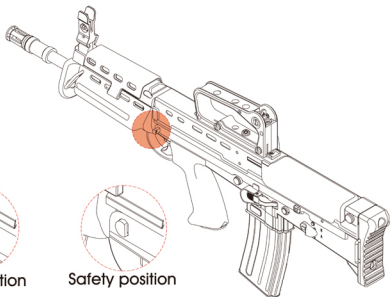

Firing position

Safety position



WARNING

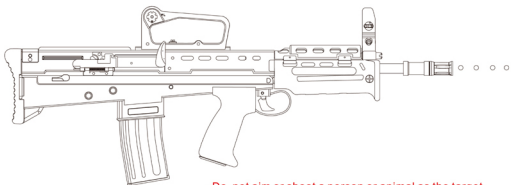

- .Do not aim or shoot a person or animal as the target.
- .Avoid pulling the trigger carelessly.
- .Always put the gun in a case or bag when you carrying it.
- .Always set the switch lever to the safety position.
- .Do not look into the gun muzzle.
- .Always wear eye protective gear.
- .Store the airsoft gun at the places out of reach by children.
- .Do not disassemble or modify the airsoft gun.

FOR MORE DETAIL INFORMATION PLEASE VISIT OUR WEBSITE

DATA OF ARES AR-002 ELECTRIC GUN

AR-002

Bolt Locking & Functional Bolt Catch



FEATURES

- All New Molding
- Steel Stamping Process
- Metal Gearbox
- Bolt Lock / Release Function
- Easy Power Upgrade

BATTERY:

MAGAZINE CAPACITY:

MODE:

MATERIAL:

MOTOR:

HOP-UP:

LENGTH:

WEIGHT:

VELOCITY:

8.4V 1500mAH Mini (2/3A) Nunchuck

130rds (6mm BB)

Full Auto / Semi / Safe

Nylon Fiber + Steel

High Torque Flat Motor

Adjustable

710mm

4100g

350-380FPS



Manufacturer & Brand Owner : Forever Good (Hong Kong) Ltd.



Worldwide:

Ares Website: <http://www.aresairsoft.com>

General Enquiries: ares@aresairsoft.com

North America: ZShot

Exclusive Distributor - <http://www.ZShot.com>

Dealer Inquires: Sales@ZShot.com Technical Support: Support@ZShot.com

ARES AR-002

