

CAA AIRSOFT DIVISION

RONI PISTOL-CARBINE CONVERSION

INSTRUCTION MANUAL FOR RONI S11





RONI

PISTOL-CARBINE CONVERSION

RONI is designed for the Special Forces operator, it has found favor with SWAT and Security Details. The RONI Pistol Carbine Conversion allows you to realize the accuracy inherent in the pistol. The RONI shoulder stock design provides the stability to significantly improve accuracy.

Compatible with:

Tokyo Marui; WE; KJ Works Gas Blowback P226
Simple modification is needed for KSC; KWA

Gas Blowback P226

Main Material:

Nylon Fiber; Aluminum

Weight: 1900g

Min. Length: 500mm

Max. Length: 575mm

CAUTION:

Read the instructions before installing this product.

This product is for airsoft only.

User of this product must be over 18 years of age.

Ensure that the pistol is not loaded prior to installation.

Always wear eyes protective gear.

CAA is not responsible for any damage due to installing or using this product.

COMPONENTS NAME

The RONI Pistol-Carbine Conversion is ergonomic designed and equipped with ambidextrous front and rear sling mounts, and large charging handle. Charging the weapon is easy and it is user friendly to both left and right handed operators. It is integrated with a CNC machined Aluminum top and 2 side rails for mounting accessories, and a Nylon Fiber lower rail to mount any forearm grip. The RONI is equipped with an adjustable 5 position buttstock, and features a spare magazine holder for faster reloading. The adjustable cheek rest on the buttstock is removable. The RONI Pistol Carbine Conversion includes a pair of flip-up sights, a detachable folding forearm grip and a charging handle.

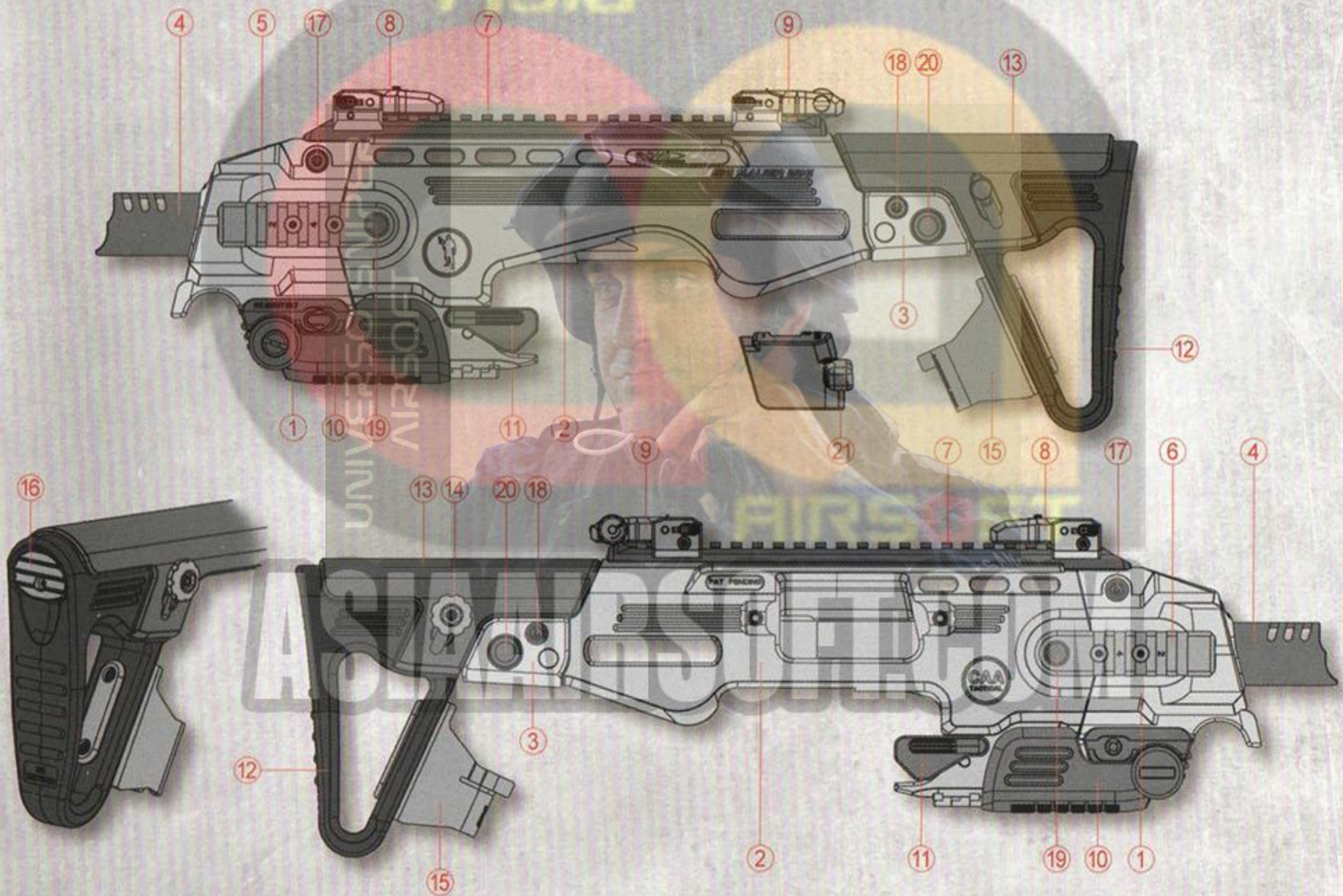

- | | | |
|-----------------------|----------------------------|-----------------------------|
| 1. Fore receiver | 8. Flip-up front sight | 15. Spare magazine holder |
| 2. Receiver body | 9. Flip-up rear sight | 16. Buttstock lock button |
| 3. Rear receiver lock | 10. Forearm grip | 17. Front safety pin |
| 4. Compensator | 11. Safety-catches | 18. Rear safety pin |
| 5. Left side rail | 12. Retractable buttstock | 19. Front sling swivel slot |
| 6. Right side rail | 13. Cheek-rest | 20. Rear sling swivel slot |
| 7. Top rail | 14. Cheek-rest lock button | 21. Charging handle |

ASSEMBLING INSTRUCTION

Step 1:

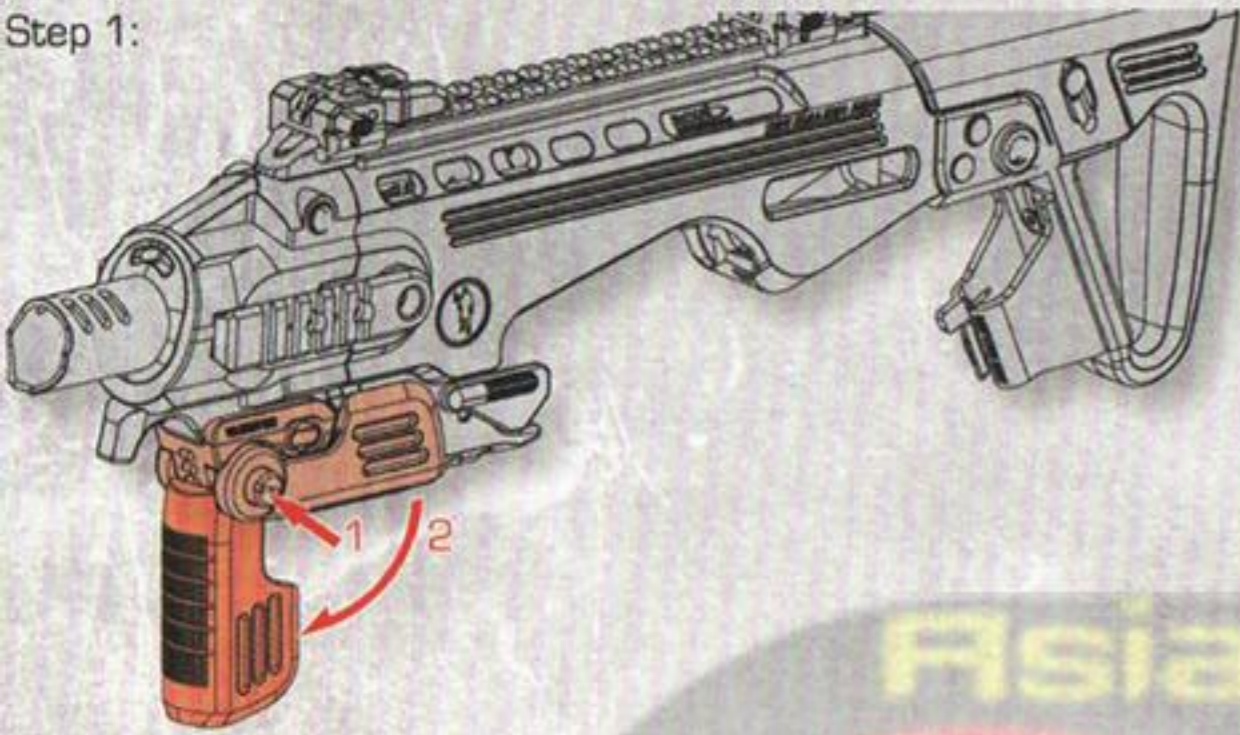

Open forearm-grip to vertical position by pushing release button and swinging grip down into position.

Step 2:

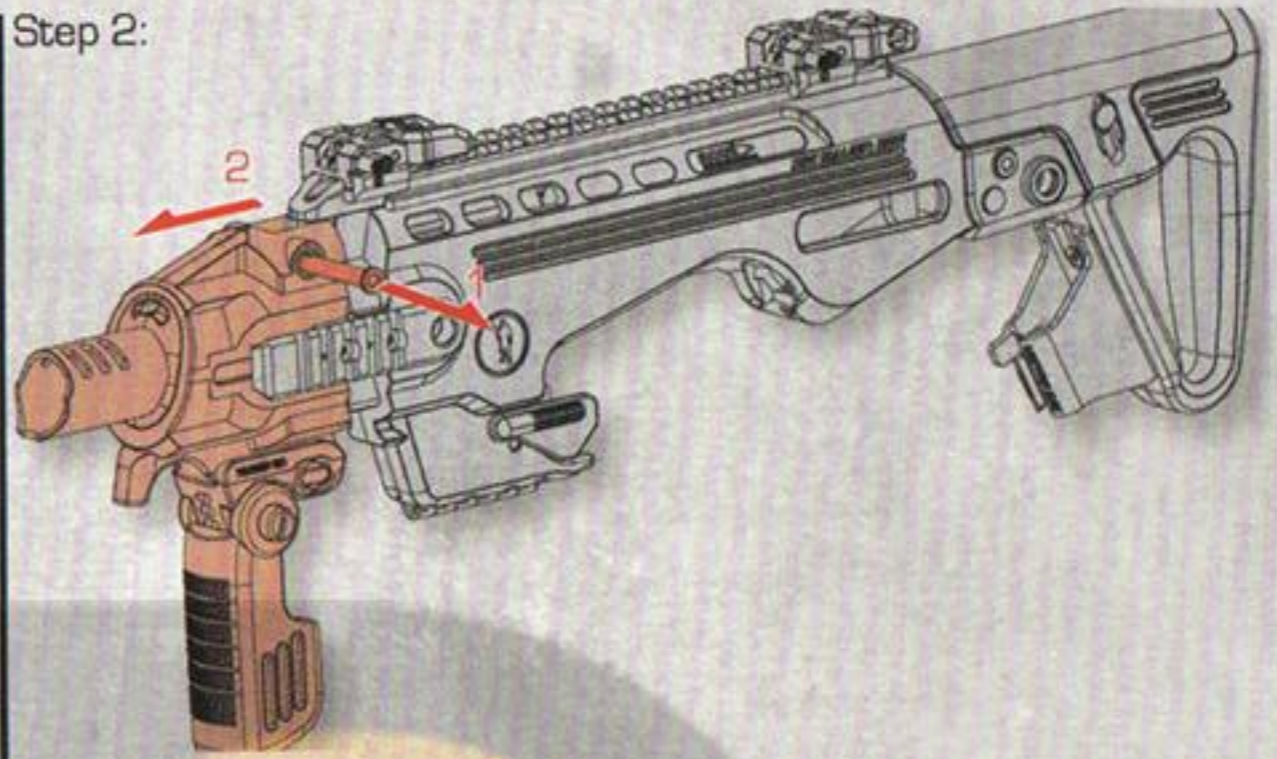

Pull the front safety pin out by pushing it thru the RONI, slide the fore receiver to fully extended position.

Step 3:

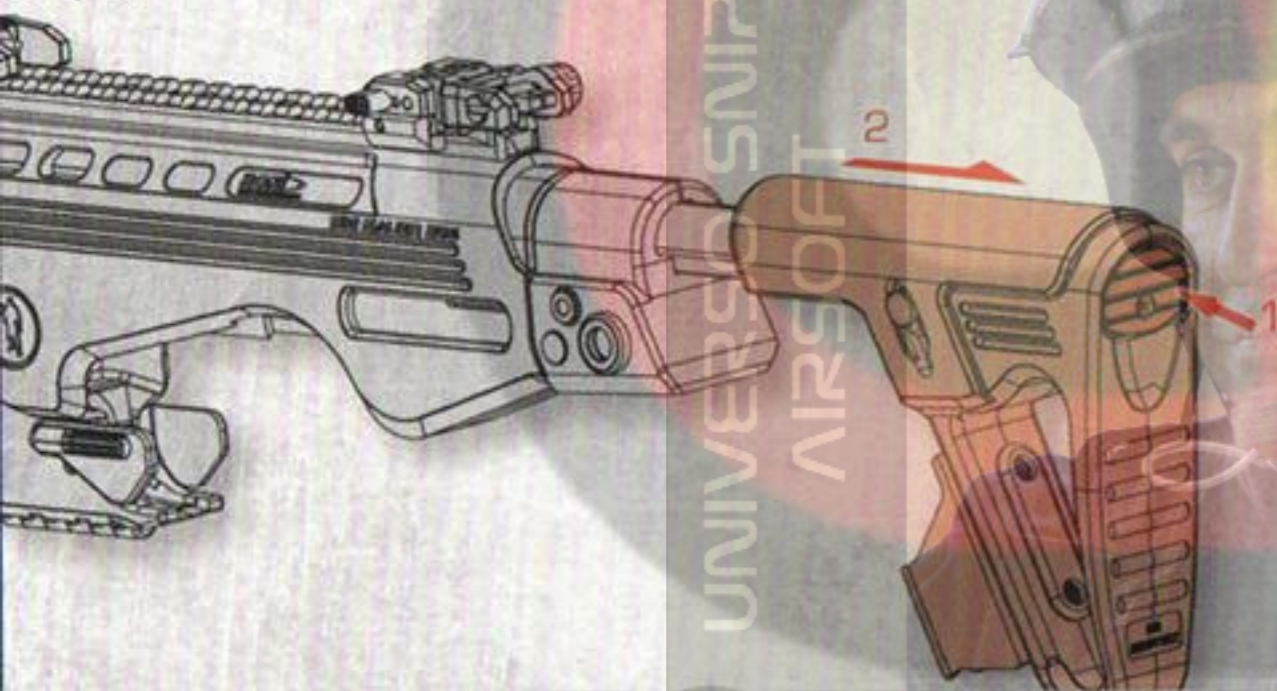

Pull the buttstock to full extension by pressing the button on the rear side of the stock.

Step 4:

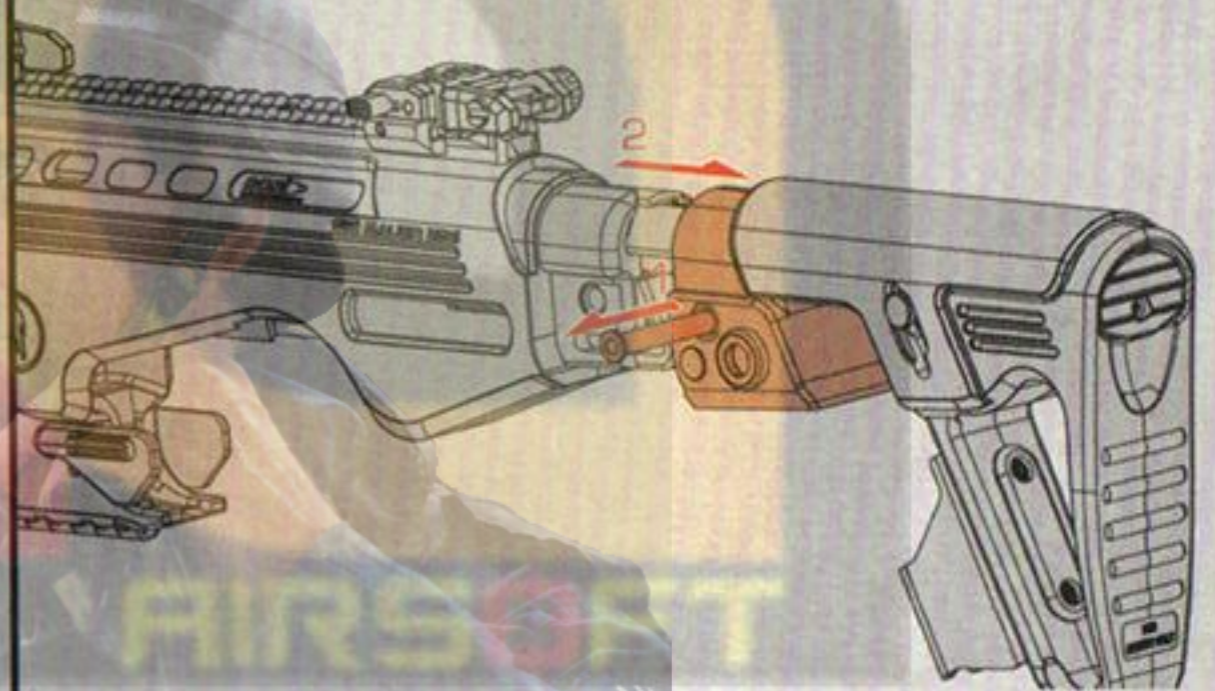

And then pull the rear safety pin out by pushing it thru the RONI, slide the rear receiver lock to fully extended position.

Step 5:

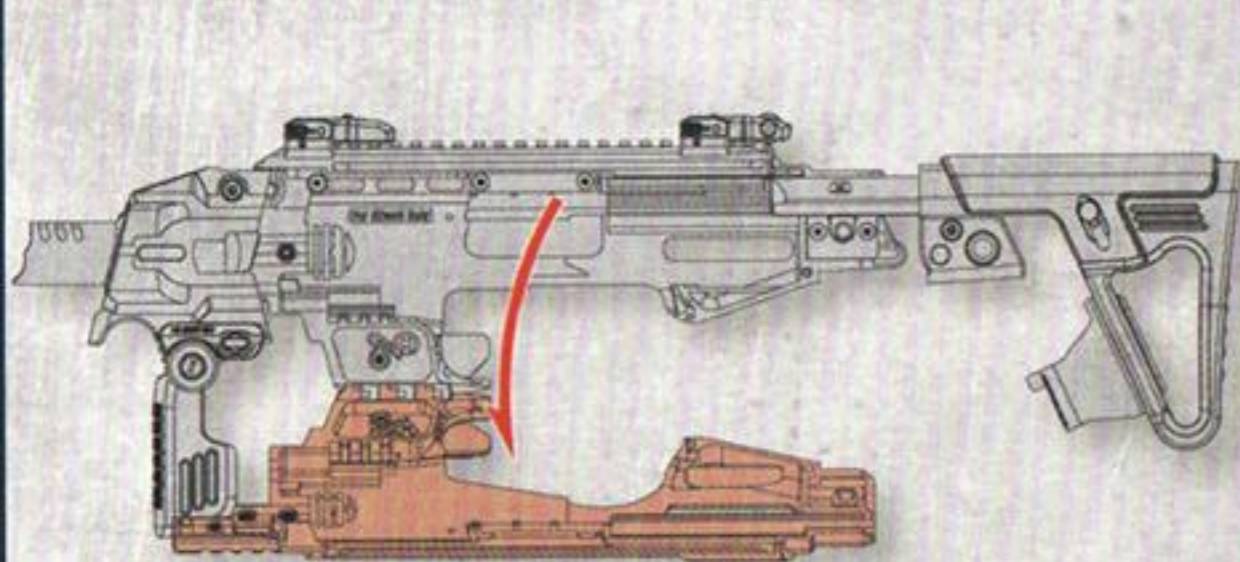

Lay the RONI down with the muzzle is pointing left, then open the body on its bottom hinge.

Step 6:

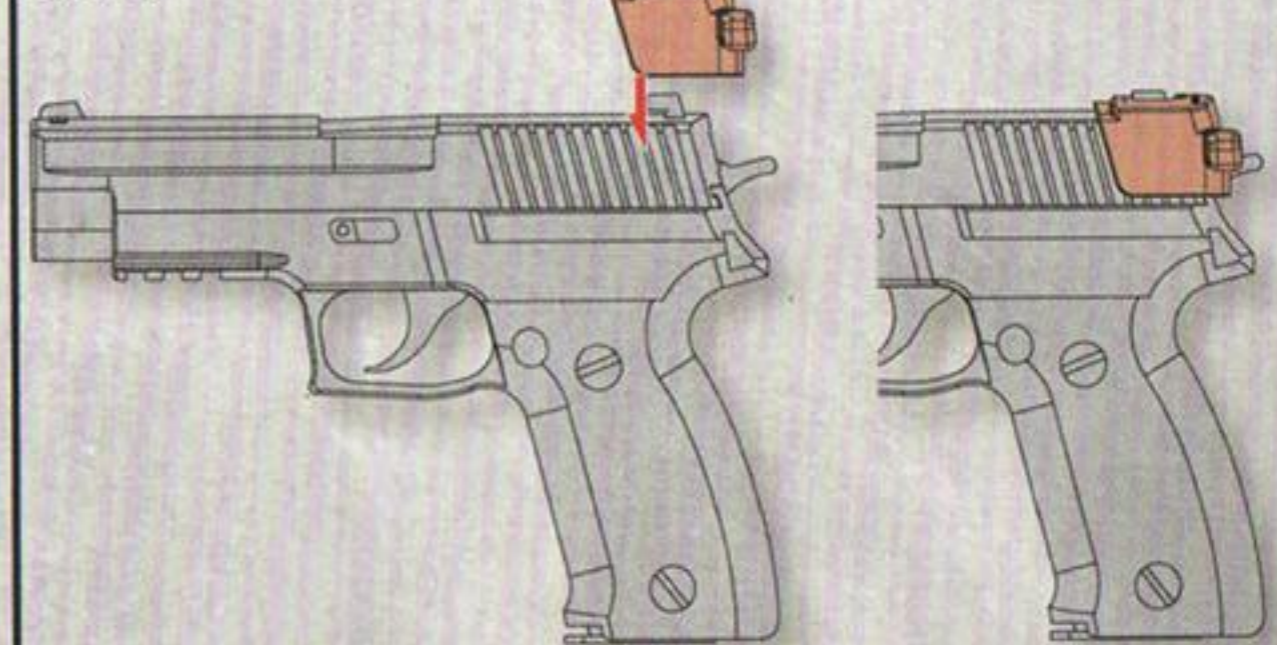

For the pistol, place the charging handle to the rear of the slide as shown.

ASSEMBLING INSTRUCTION

Step 7:

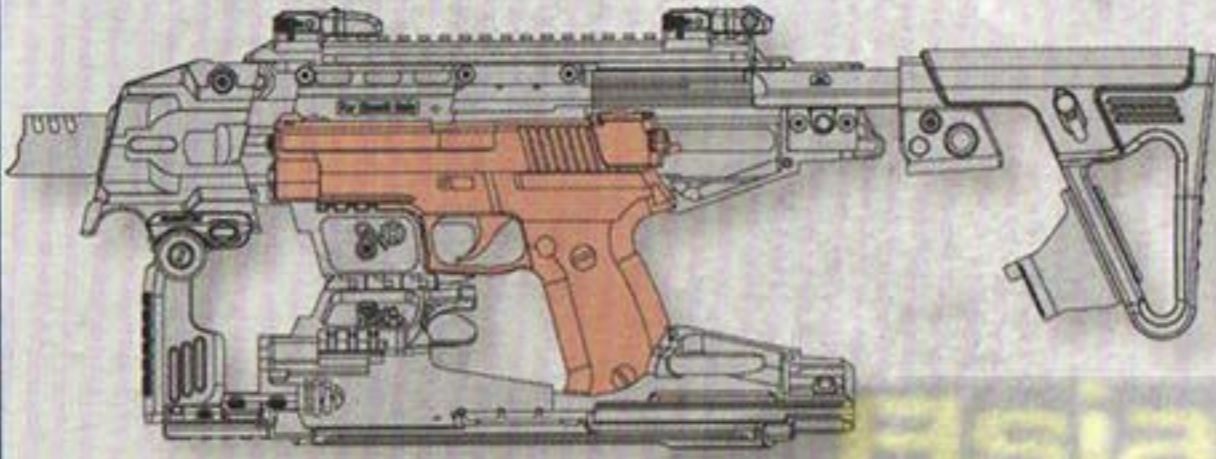

Place pistol directly into position making sure it is laying flat.

Step 8:

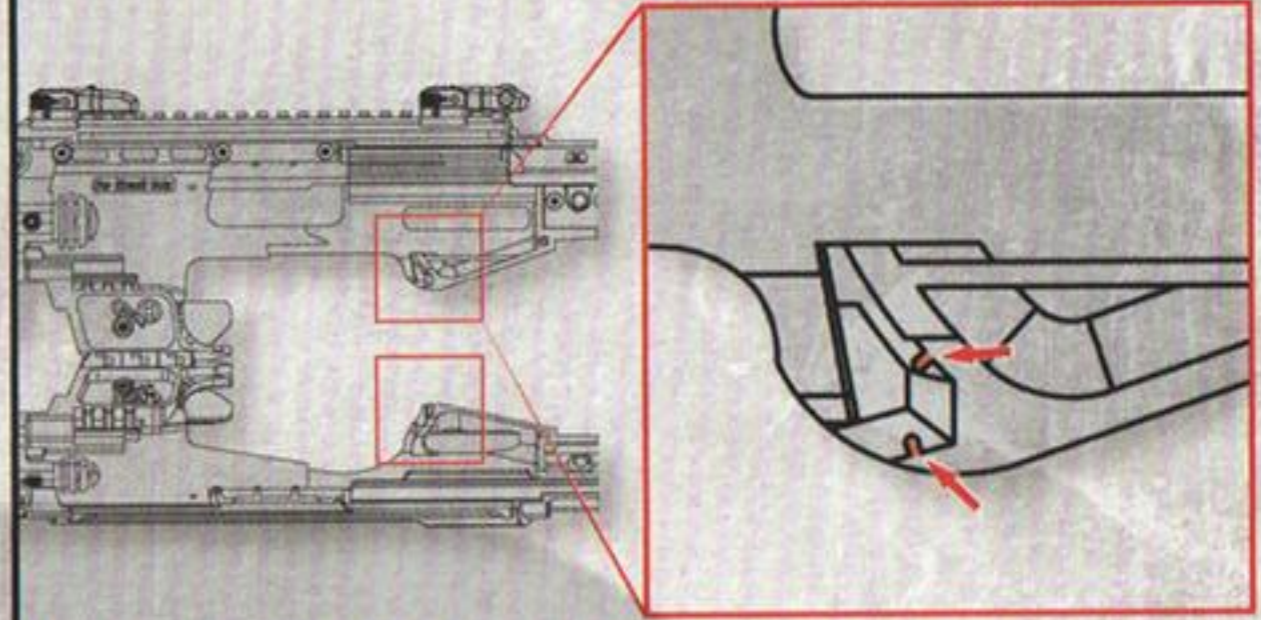

For KSC and KWA P226, cut the ribs off indicated on the both side of the RONI body until the rear part of the pistol is able to fit into it. *Professional help is recommended for this modification.*

Step 9:

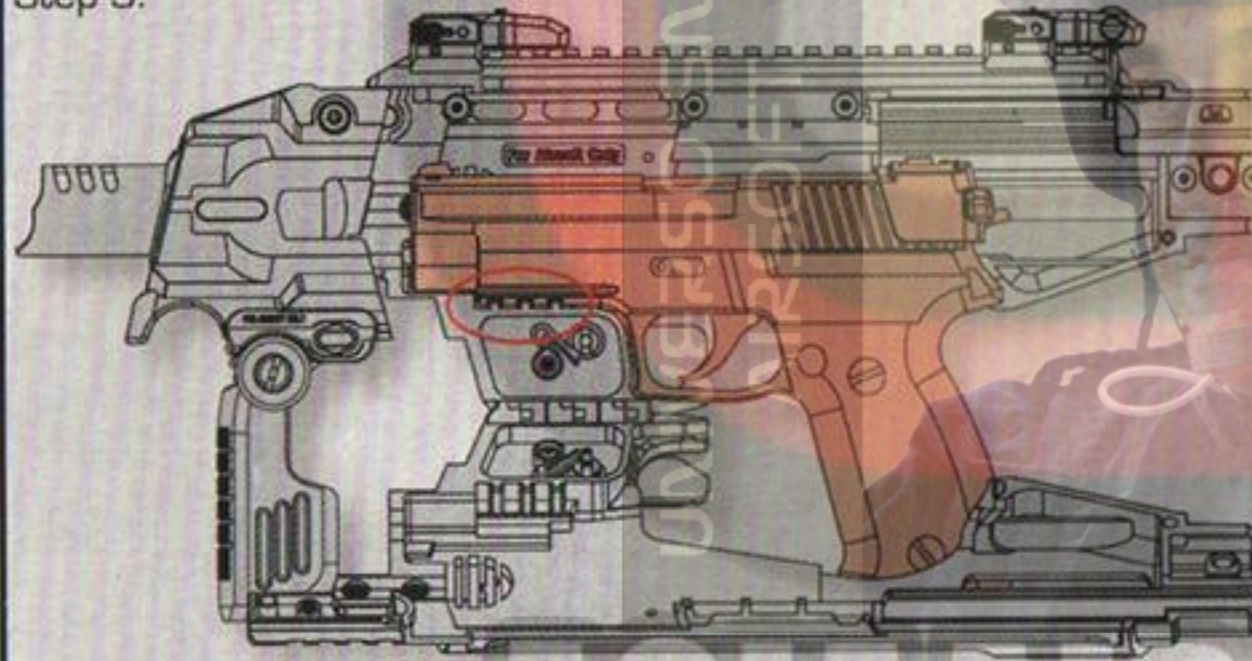

Make sure the under barrel rail slot on the pistol is engaged to the male rail bar on the RONI.

Step 10:

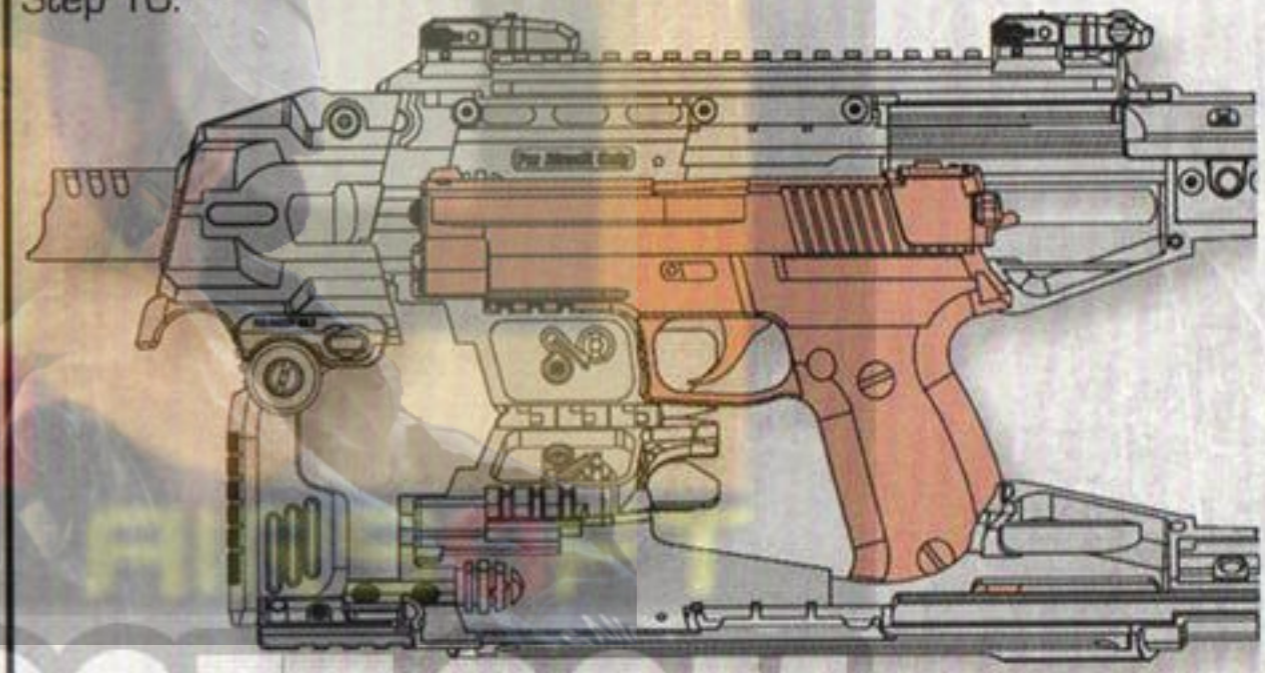

Also, make sure the pistol and charging handle are locked into position before folding hinged body back over.

Step 11:



Make sure that both safety-catches are locked at the same position, then close the body.

Step 12:

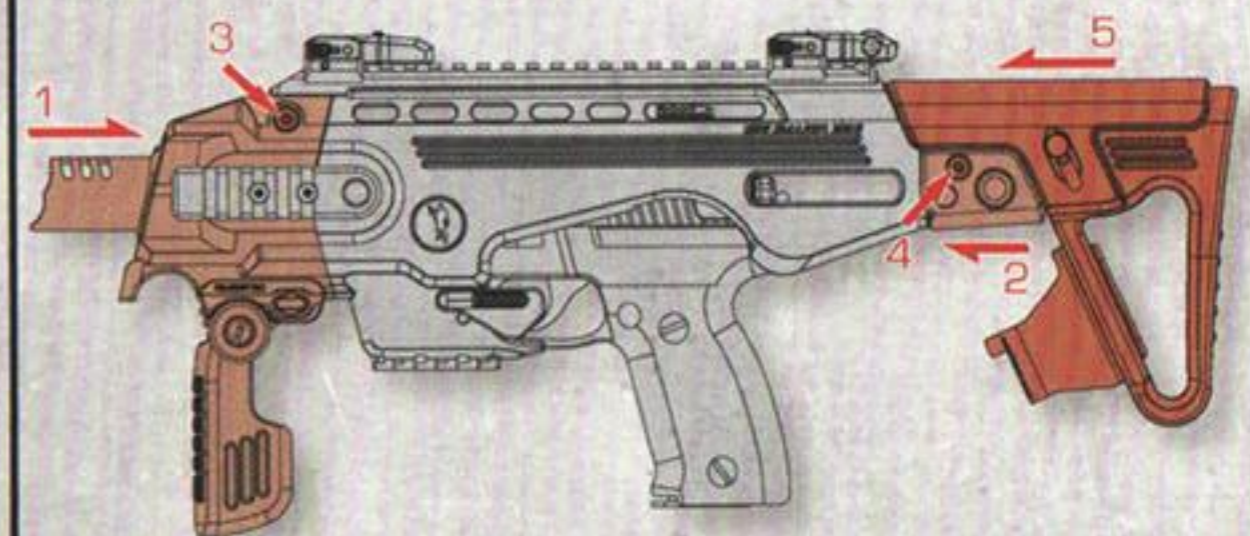

Push the fore and rear receiver lock back together into locking position, then place pins back into place.

OPERATING

Folding Flip-up Sights 1:

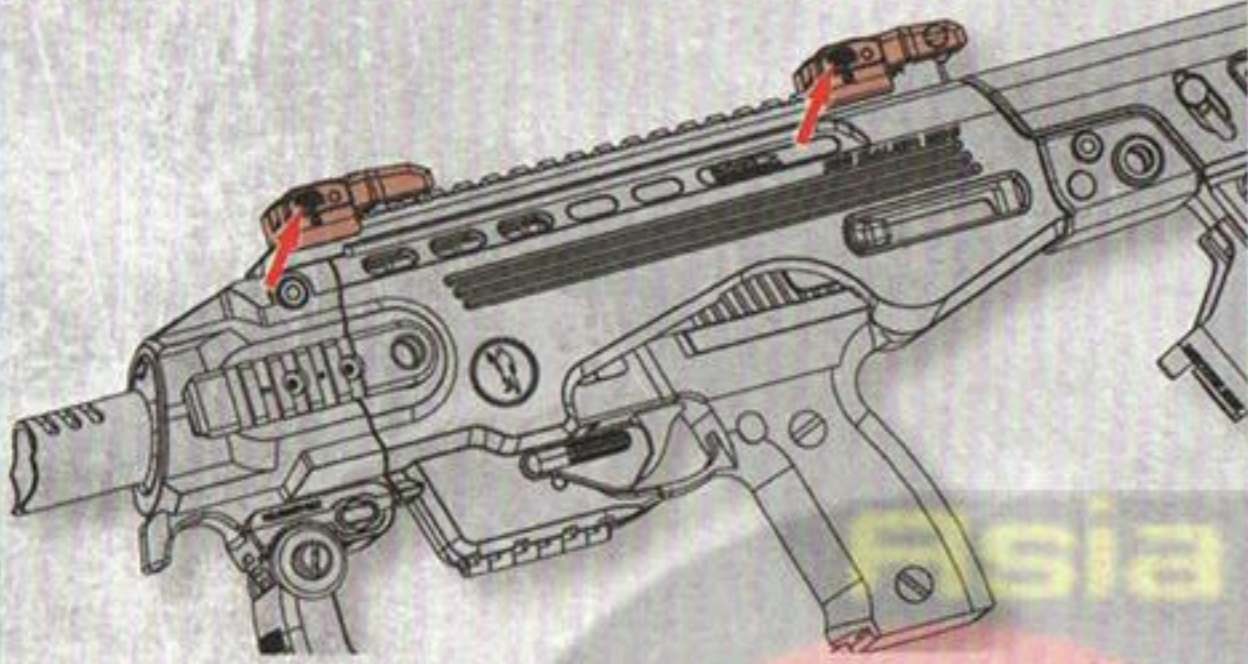

Push the button indicated to raise the sights. The push button can be ambidextrously accessed.

Folding Flip-up Sights 2:



Press the sights to lay it down, the sights will be locked automatically.

Folding Forearm Grip 1:

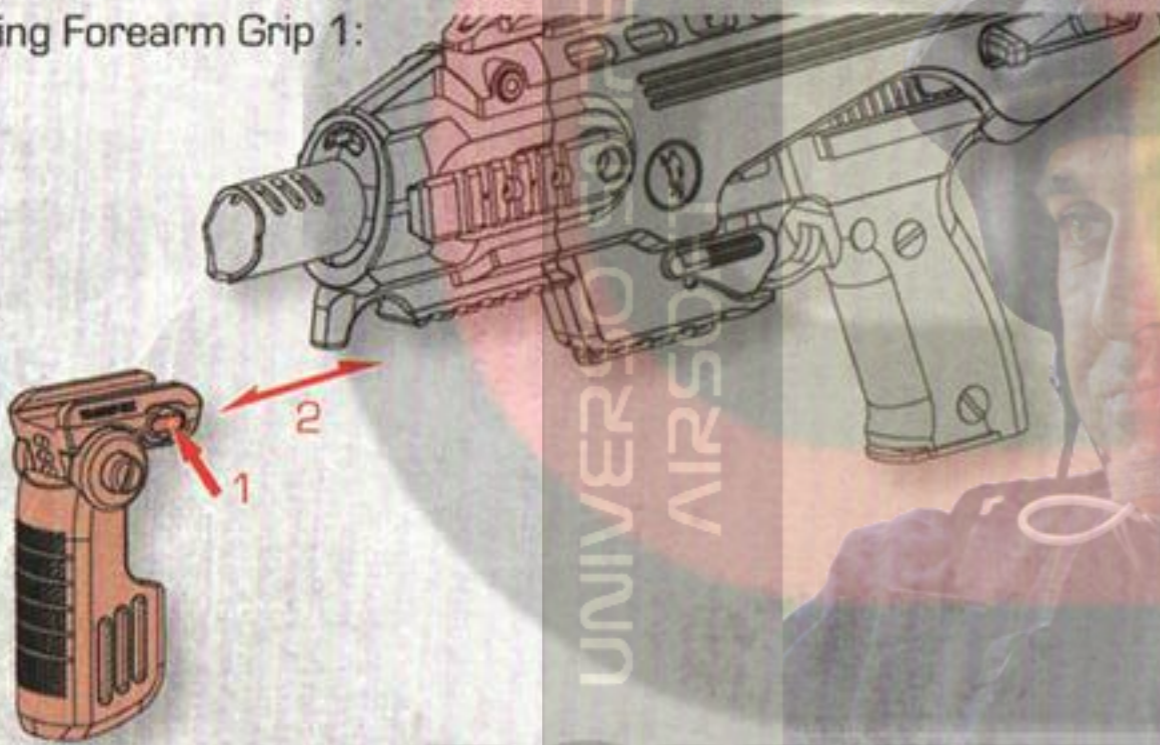

Press the button indicated to install or remove the forearm-grip.

Folding Forearm Grip 2:



The position of the forearm-grip can be changed by pressing the button indicated.

Sling Swivel:



A sling swivel (not included) can be installed on the front and rear slots on both sides as shown.

Loading The Pistol:



Large charging handle for fast charging the pistol. It can be ambidextrously accessed.

OPERATING

Safety Catch 1:

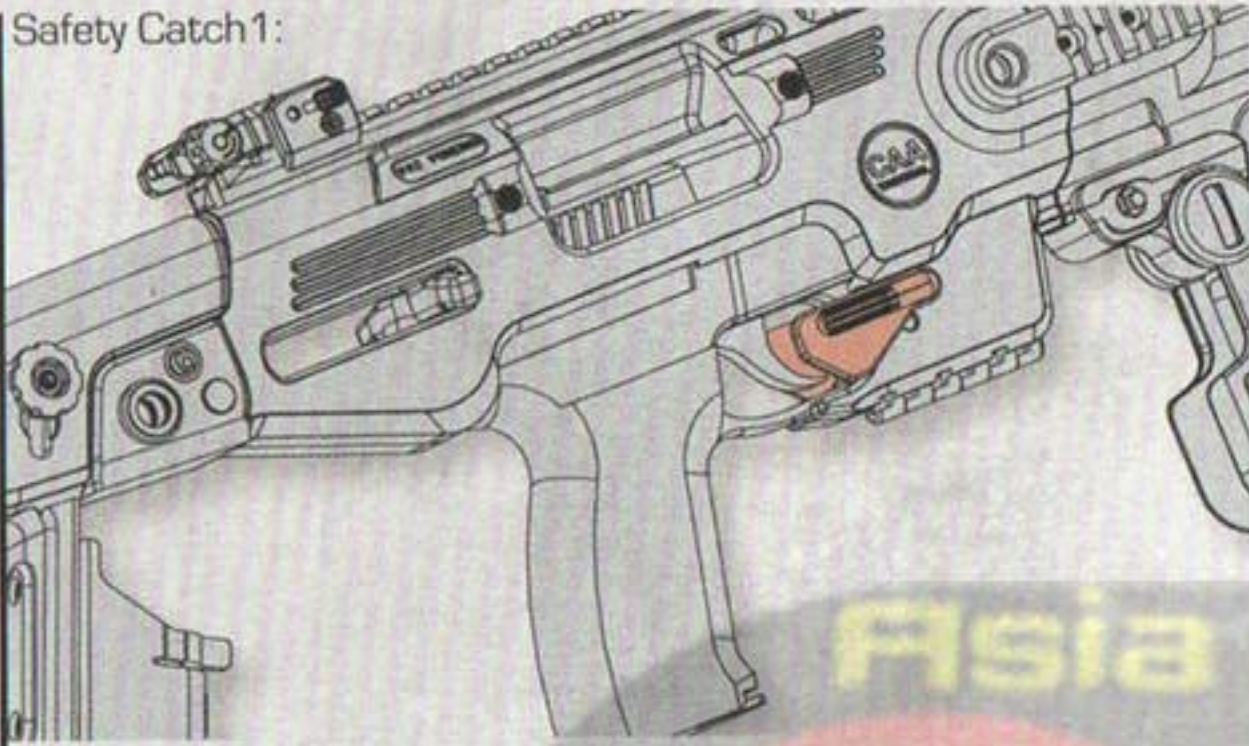

Always set the safety catch to the SAFE position when you are not firing the pistol.

Safety Catch 2:

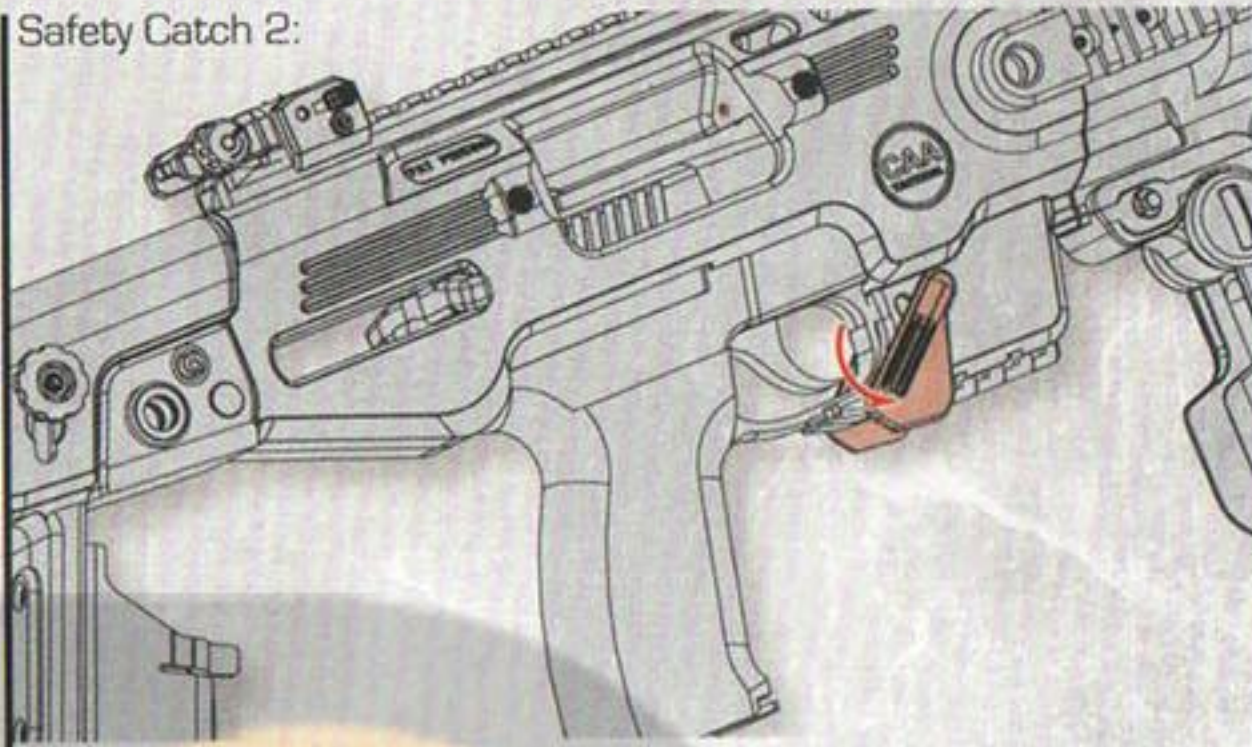

Set the safety catch down and you are ready to fire. It can be ambidextrously accessed.

Spare Magazine Holder 1:

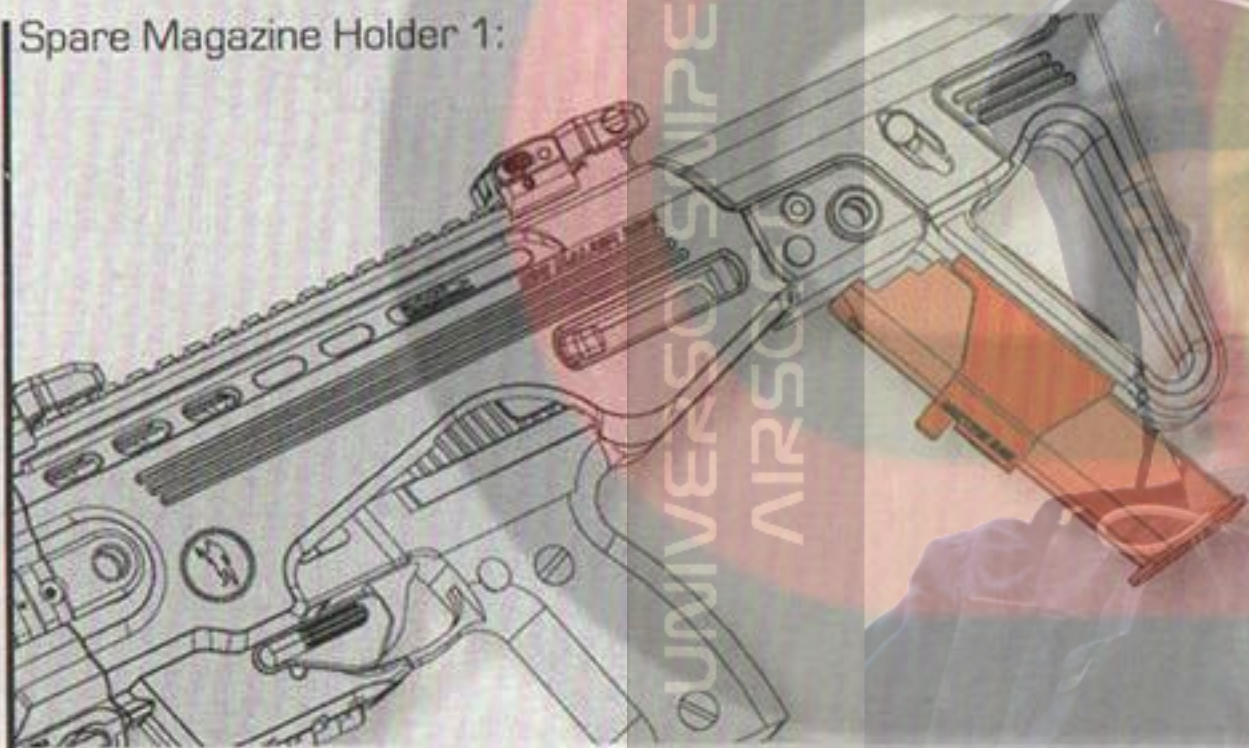

A spare magazine can be installed on the spare magazine holder on the buttstock for quick magazine reload.

Spare Magazine Holder 2:

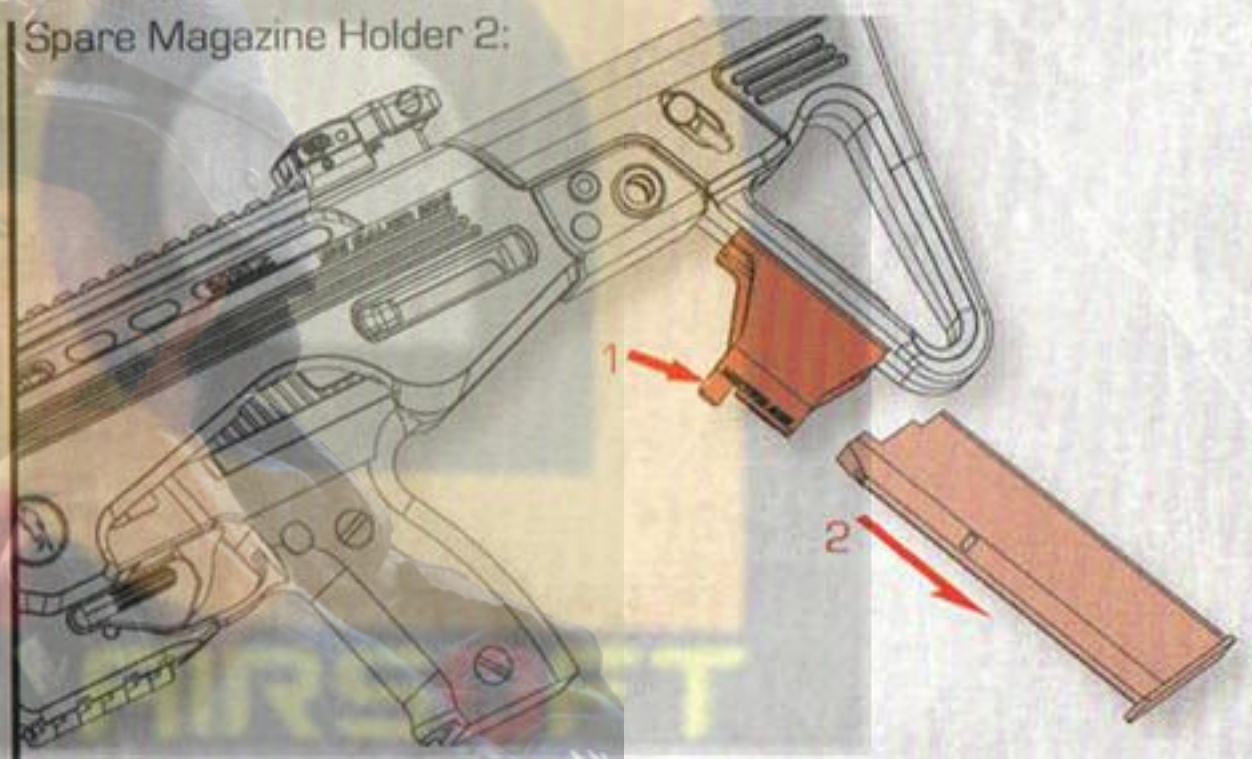

Press the release clip to take the magazine out.

Buttstock 1:

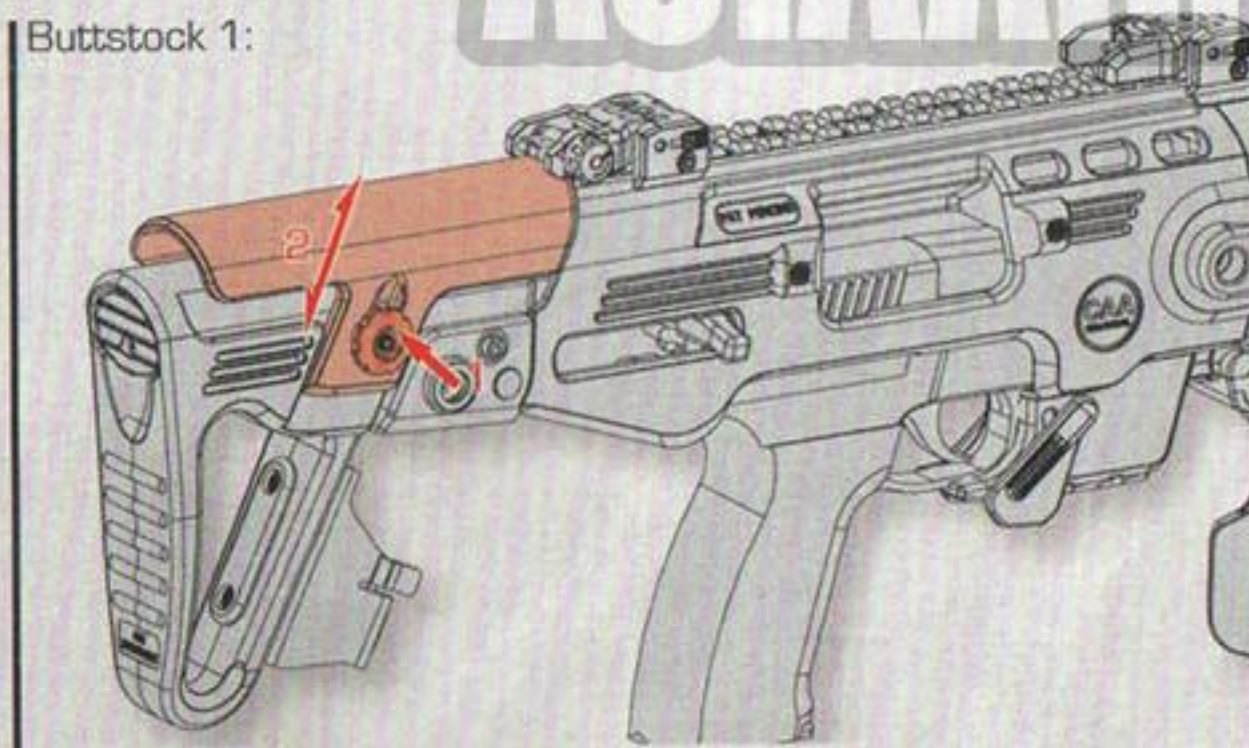

Loose the locking button indicated to adjust the height of the cheek-rest. The locking button can be placed on either side of the stock.

Buttstock 2:



Press the button on the rear side of the stock to extend or retract the buttstock. It can be set in 5 different positions.



CAA AIRSOFT DIVISION



RONI PISTOL-CARBINE CONVERSION

WWW.AIRSOFT.COM