

# SAR EUROPA SPORT KURZKARABINER

AIRSOFT ELECTRIC GUN

· Movable Cocking Lever and Blot Cover

· Metal Flash Hider

· 7mm Bearing Gear Box

· High Performance Motor

· Real Schwaben Logo with unique serial number



· Bearing Spring Guide

· Hi-Cap Magazine (220 Rd)

· Metal Hop Up Chamber

· Quick Disassembly Metal Body

· Bearing Piston Head & Advanced Power Spring

**CA036M**



## 1 Outlook / Structure

Always set the selector switch to the safe position when you are not firing or during storage

### SAR Europa Sport Kurzkarabiner

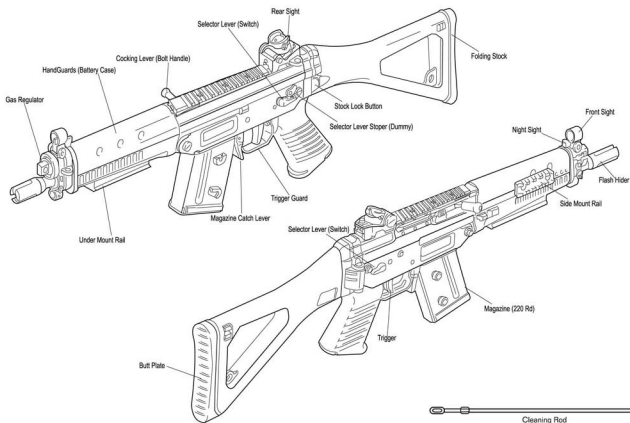

## 2 Specification

### Data of Automatic Electric Gun

Name	SAR Europa Sport Kurzkarabiner		CA036M
Weight	2.75 Kg		
Barrel Length	247mm		
Barrel Caliber	6.08mm		
Pellet Capacity	220		
Pellet	6mm BB		
Initial Pellet Speed	95~120 m/s		
Battery Type	Mini Type (8.4V)		

## 3 Operation

### 1 How to use safety lock

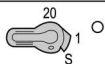

S : Safety Lock



1 : Semi Auto



20 : Full Auto

## 2 How to insert battery

Set the battery after charging

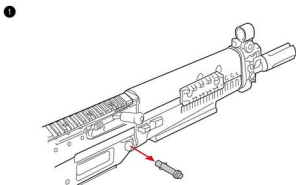

1. Pull out the lock pin.

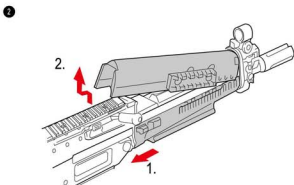

2. (1) Slide the lower hand guard backward until it stops.  
(2) Remove the upper hand guard by pulling upwards.

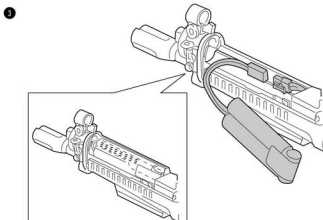

3. Connect the connectors and store the battery in the battery holder.

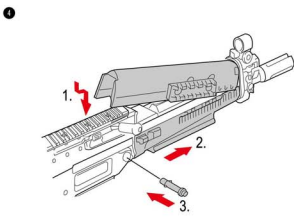

4. Reinstall the hand guard in the reverse order of the removal procedure.



• Be careful with your fingers

## 3 Magazine Attachment / Detachment procedure

High precision BB pellets is required for the operation of this magazine. Avoid invasion by dust and dirt into the magazine to prevent malfunctions.

### Action against Problem

Failure in pellet feeding may occasionally occur during full auto operation. In this case, disconnect the magazine, give a slight shock or poke BB pellets using a stick and then set the magazine again.



About 20 pellets will remain in the duct after operation. Be careful of any pellets firing out if you hold the gun up-side-down and pull the trigger.

### Ensure Smooth Pellet Feeding

Occasionally give slight shocks to the gun or shake vertically to ensure smooth pellet feeding. Slightly turn the gear every 50 to 60 pellets to ensure smooth pellet feeding.

1 Press the magazine catch to detach the magazine

2 Open the top hatch and insert BB pellets. (About 500 pellets can be loaded. (Avoid forcing BB pellets into the magazine.)

3 Magazine can be connected. Hook the upper joint, turn the magazine and lock by the lower joint.

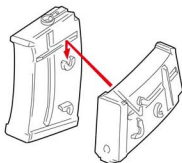
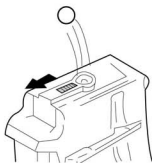
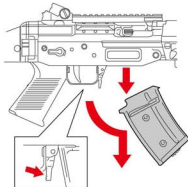

## 4 How to fire

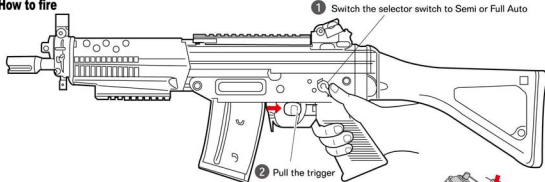

\* A blank firing may occur at triggering after setting the magazine, this is the normal operation of the gun.

### Cautions on Motor and Battery

- Change the battery if the firing cycle becomes slow.
- Give the air gun a rest for 5 to 10 minutes after firing about 500 pellets, in order to ensure high durability of the motor and battery.

### When pellets are clogged

- If pellets are clogged, remove them and apply a few drops of silicone oil into chamber from the magazine entrance as shown or spray silicone oil for 0.5 to 1 sec to obtain smooth continuous firing. (Never use CRC-556 or other mineral oil)



- There are possible cases that no firing occurs after pulling the trigger in the semi auto mode. In case, do not pull the trigger furiously. Fire 5 to 10 pellets in the full auto mode and then return to the semi auto mode.



- Small may be generated from the motor for a while when a new air gun is operated, this is the normal operation of the gun.



- The hop up operation may be unstable for 200 to 300 pellets after using silicone oil, this is the normal operation of the gun.

## 5 How to fold the stock

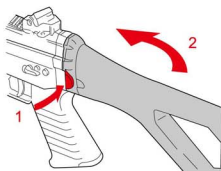

1 Press the stock lock button to fold the stock

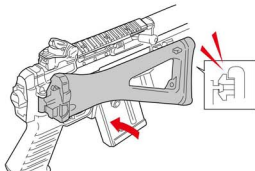

2 Stock can be locked to the hand guard

## 6 How to adjust the hop up system

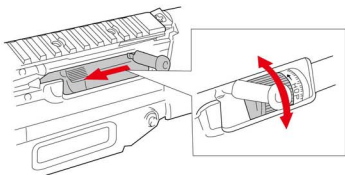

1. Continue to pull the cocking lever while adjusting the dial.
2. Turning excessively adversely affects the trajectory. So, stop turning the hop up adjustment dial when bullets fly horizontally.
3. The hop up dial can only be turning a certain amount. Turning it too much will damage it.



Over turning towards the hop up will cause pellets clogging easily. Keep pulling the trigger with clogged pellets will damage the piston and gears.



Be careful with your fingers.

## 7 Rear Sight Adjustment

1. Normally, turn down the night-sight as shown in the figure. The night sight is a dummy.

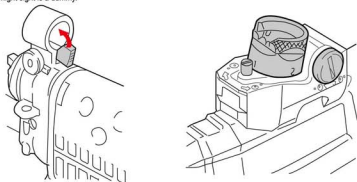

3. Turn the adjustment screw using a  $\oplus$  screwdriver to adjust the sight height.



4. Turn the adjustment dial using a coin or screwdriver to adjust the sight horizontal position.

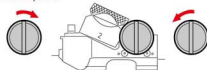

## 4 Maintenance

### 1 How to use a cleaning rod

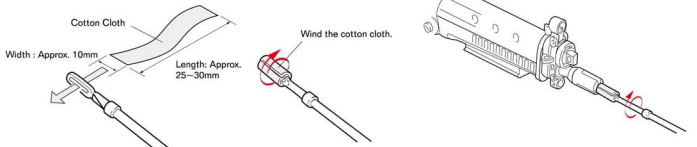

Cut a cotton cloth to the size shown above and insert one end into the hole in the rod.  
(Adjust the length of cloth for smooth entry into the barrel.)



CAUTION: Always begin the maintenance by returning the Hop Up adjustment lever to NORMAL.



CAUTION: The chamber is a precision component.  
Never use any used BB pellets.

\* The hop-up performance may become unstable for 60 to 70 pellets after maintenance.

1 Spray silicone oil for 0.5 to 1 sec in the pellet entrance, then fire 40 or 50 pellets to make the magazine more stable.

2 Clean up the oil from the chamber by using the cleaning rod (with cotton) to complete the maintenance.

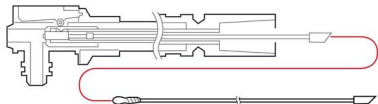

20A Glass Tube Fuse is used



Hold the tip of the rod and insert it with turning motion.

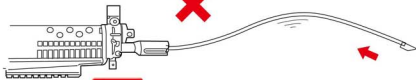

Inserting the rod will be difficult if you hold the rod at the end.



CAUTION: Always begin the maintenance by returning the Hop Up adjustment lever to Normal.



Never use any used BB pellets

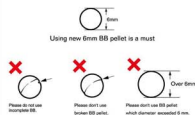

## 5 Fuse Replacement Procedure

1 The fuse box is accessible when the fore grip is remove.  
Remove the fuse attaching band while pushing the catch. Open the fuse box and replace.

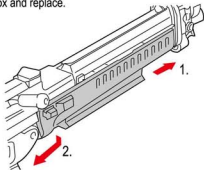

2 Open the fuse box from inside the hand guard and replace the fuse.

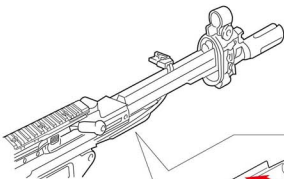

3 Pull the trigger while adjusting the set screw to the left or right.  
Stop turning when the motor is the quietest.

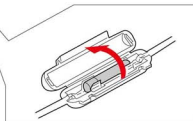
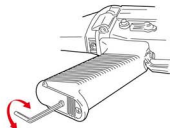

## 6 WARNING

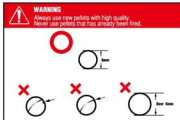

In no event shall Classic Army or any of our partners be liable for any direct or indirect, special, incidental, or consequential damages in connection with the use of our products.

## 7 For complete product information, dealer locations and technical support, please visit the website of Classic Army Sole Distributors.

### Italy, San Marino Republic, Città del Vaticano, Spain (includes Andorra and Gibraltar)

**Portugal and Switzerland**  
Co. Name: Evokation International S.r.l.  
Add.: Via dell'Annunziata n.31, 20121 Milan, Italy  
Tel: (39) 02 25499027  
Fax: (39) 02 25118336  
Email: info@evokation-airsoft.com  
Website: www.evokation-airsoft.com

### Denmark, Sweden, Norway & Finland, France, Germany, Austria, United Kingdom, Poland, Baltic countries, Belgium, Luxembourg, the Czech Republic and Slovakia

Co. Name: ActionSportGames AG  
Add.: Bakkegaardvej 304, DK-3050 Humlebaek, Denmark  
Tel: (45) 89 28 18 88  
Fax: (45) 49 19 31 60  
Email: sales@actionsportgames.com  
Website: http://www.actionsportgames.com/

### The United States of America

Co. Name: Spartan Imports, Inc.  
Add.: 213 Lawrence Avenue, S. San Francisco, California, USA 94060  
Tel: (1) 650 589 5501  
Fax: (1) 650 589 5552  
Email: info@spartanimports.com  
Website: http://www.spartanimports.com/

### Taiwan

Co. Name: F-Links Int'l Enterprise Co. Ltd.  
Add.: No.3 Lane 62, Jingjiao 1st Rd., Lingya District, Kaohsiung City 802, Taiwan, R.O.C.  
Tel: (886) 7-710 0198  
Fax: (886) 7-710 0398  
Email: kasa.kasa@msa.hinet.net  
Website: http://www.soloman.com.tw/

### Thailand

Co. Name: Vostech Co., Ltd.  
Add.: 92 Kasat - Nawamintra Rd. Soi Ladplacow 39 Jorakebua Ladphrao Bangkok  
Tel: +662 9402629 (auto 4 lines) / +668 1 8692117  
Fax: +662 9402679  
Email: polaris\_adventure@yahoo.com  
Website: http://www.classicarmy-thailand.com

### Japan

Co. Name: Union Fire Company (UFC)  
Add.: 562-0867 6-10-101 - MATSUYAMACHI, CHUO-KU, OSAKA, JAPAN  
Tel: +81-6-4304-7750  
Fax: +81-6-4304-7799  
Email: ufctrading@ufc-web.com  
Website: http://www.ufc-web.com/

### Ukraine

Co. Name: Vizantiya-1  
Add.: Kiev Av. A. Navoi, 7/6, Ukraine  
Tel: (380)44 4084369  
Fax: (380)44 4080633  
Email: vizantiya\_1@svtzone.com  
Website: http://www.militarist.com.ua/

## 8 Exploded Diagram

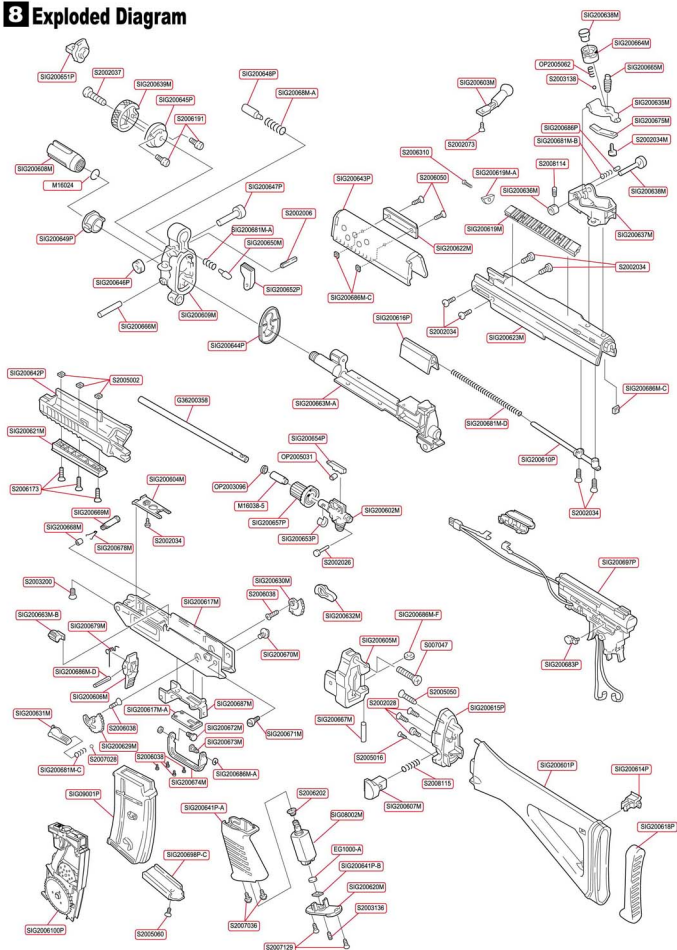



CLASSIC ARMY

[www.classicarmy.com](http://www.classicarmy.com) [info@classicarmy.com](mailto:info@classicarmy.com)

## HANDLING CAUTIONS AND INSTRUCTION MANUAL

UNIVERSO SNIPER  
AIRSOFT



### WARNING

- FOR AGE 18 OR ABOVE.
- PLEASE READ THE INSTRUCTIONS CAREFULLY BEFORE USE. MISUSE OR CARELESS USE MAY CAUSE SERIOUS INJURY.
- USER SHOULD OBEY TO THE LAWS REGARDING THE USAGE AND OWNERSHIP OF AIRSOFT ELECTRIC GUNS.
- FACIAL PROTECTION IS REQUIRED.

Produced By Classic Army, Hong Kong

2009-5-27 Edition 1 Yick Fung Ind. Int'l Ltd. All Rights Reserved



Schwaben Arms and SAR Logo are registered trademarks of Schwaben Arms GmbH, Germany used under worldwide exclusive license for Air Soft Guns by VI.SE.LE Italiana S.r.l. , Italy. [www.visele.it](http://www.visele.it)