

**BOYI** Airsoft **Aeg**

AIRSOFT ELECTRIC GUN  
PRODUCT BY BOYI.MADE IN CHINA  
U.S. SOCOMS ASSAULT CARBINE

Rail Interface System and modular weapons

# R.I.S

## M4A1 R.I.S VERSION

**使用操作说明书**

HANDLING CAUTIONS AND INSTRUCTION MANUAL



**使用之前请先仔细阅读说明书**

Always read through this manual before operation.



### 警告 WARNING



18岁 以上年龄才能使用  
The age over 18 years  
of age then can use

18岁 以上的年龄才能使用这支汽枪  
The age over 18 years of age then can use this vapor gun



注意受损伤  
Injury caution

因为BB 弹能达到20-30米范围, 不小心的射击将可能导致眼睛受损伤或其它伤害  
Since plastic BB bullets reach 20 to 30 meters, careless shooting may cause eye damage other injuries.



注意熟读警告指示手册  
Careful reading of  
Handling cautions  
and  
Instruction manual

使用前请先阅读说明书, 保存此说明书以供日后使用参照。  
Always read through this manual before operation. Remain this manual for future reference.

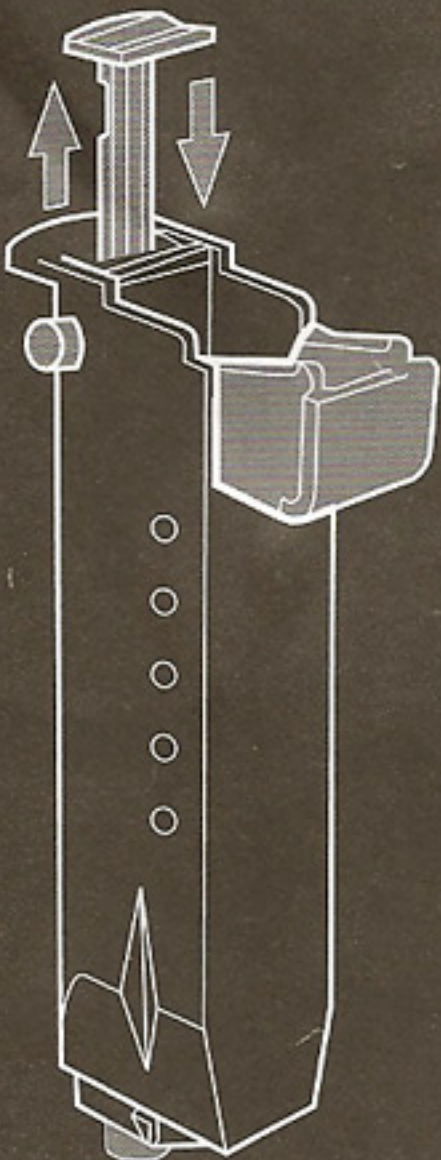



# THE NAME OF PARTS 各部分名称

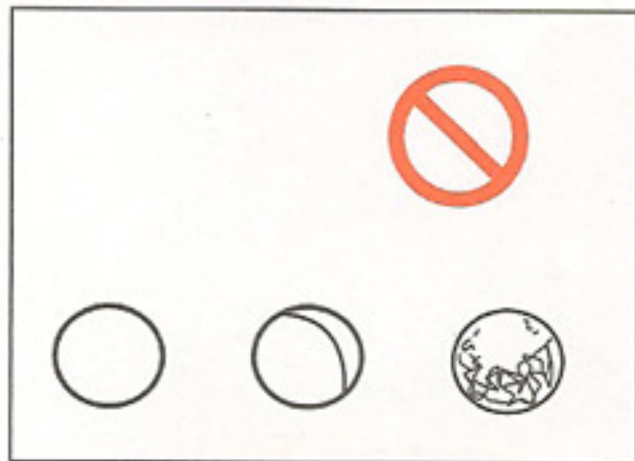
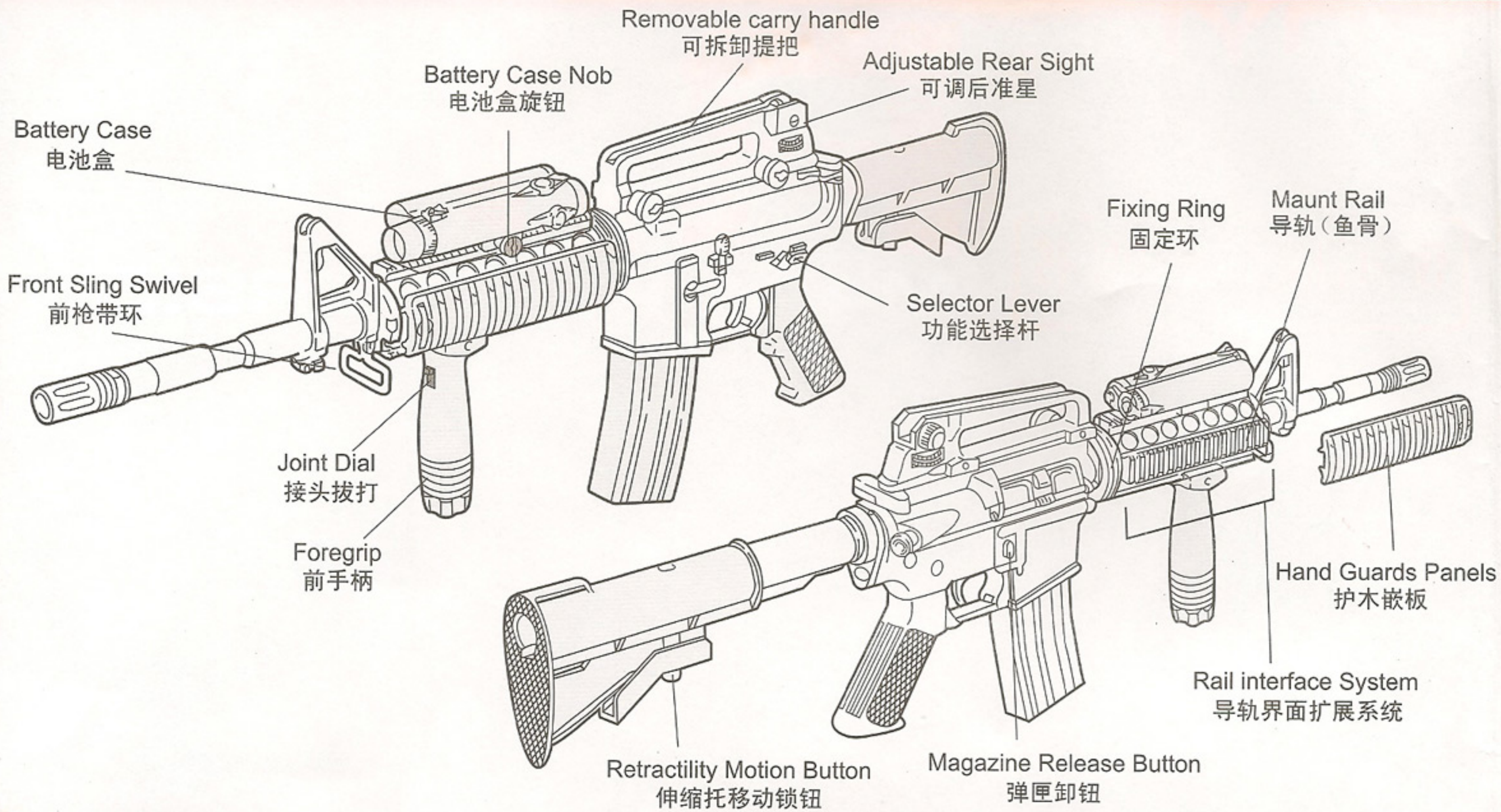

- Always use precision BB Bullets for this air gun. Never use any used BB bullets.  
请使用精密BB子弹。不要使用任何使用过的BB子弹。



- Don't disassemble beyond what is necessary. Or the gun may be damaged.  
不要随意拆解，以防枪可能被损伤。



- Don't look directly into the gun barrel to avoid accidental discharge of BB.  
不要直接察看枪管，以避免BB弹意外发射。



- Never hold the gun sideways as the BB bullets will curve right or left. This is due to the HOP-UP system.  
切勿把枪侧置射击，因为上翻弹(HOP UP)功能会导致弹道偏向左侧或右侧



- Never aim or shoot a person or animal as the target. Always set the selector on SAFE position except when you are ready to shoot a target.  
不可把人或动物当作目标瞄准或射击。在没决定射击时请把选择杆拨在SAFE档。

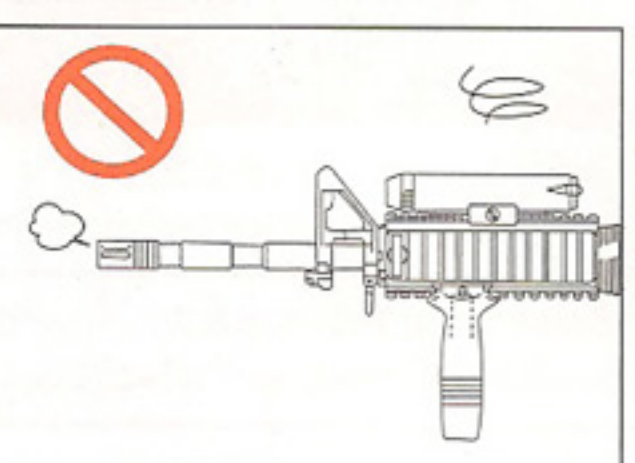

- When bullets are clogged, immediately stop operation. Remove clogged bullets and then restart operation of the air gun.  
当塞弹时，立刻停止操作。清除阻塞子弹，然后重新操作气枪。



- Pulling the trigger with the Safety lever being set to SAFE may damage the gun.  
当选择杆拨在SAFE档时，切勿用力扳动扳机



- Smell may be generated from the motor for a while when a new air gun is operated, this is the normal operation of the gun.  
刚使用新枪时，马达运转一阵后可能会产生气味



- Select a safe place for operating the air gun, avoiding places where people and cars pass cross or third persons are around.  
选择一个安全的地方操作气枪，避免在有人和汽车的路上操作气枪。



Laser Aim Module\* 激光瞄准器\*

Bullet Loader 装弹器

Shooting Glasses 防弹眼镜

Handle 握把

8.4V Rechargeable battery 8.4V充电电池

Special charger 专用充电器

Flashlight\* 照明手电筒\*

Charger 磁填充管

Charging Rod 磁填充棒

Cleaning Rod 疏通棒

三点式战术枪带  
**TACTICAL 3 POINT SLING**

注：配置中带\*的只用于特定包装  
Parts added\* symbol are suitable for specific packing only.

① Pull back ring and remove lower R.I.S 拉回固定环并移动R. I. S下半部分

Lower R.I.S. 下半部分 R. I. S

Insert as shown. 按所示插入

② Attach connector. 电池接口

Click 咔哒

③ Place connector into slot, pull back ring and replace lower R.I.S. 把连接部分放进槽中, 拉回固定环并装回R. I. S下半部分  
Caution, connectots position. 注意, 连接器位置

HANDGAURD PANEL, BATTERY CASE ADJUSTMENT 护板/电池盒调整

push down on spring and move forward. 按下弹簧片向前推动护片

Handgaurd Panel 握把护片

Rail panel relraise 导轨护板卸钮

Spring 弹簧条

By removing the handgaurd panel the battery case may be moved to the side. 通过移动面板, 电池箱可被移至侧面

Removing the Battery Case 移动电池盒

Loosen the interface knob after removing the battery 松开界面旋钮可移动电池

Interface knob 界面旋钮



# SETTING THE MAGAZINE 弹匣装填

- ① Press the magazine release button to remove the magazine  
按弹匣卸钮，取出子弹匣。

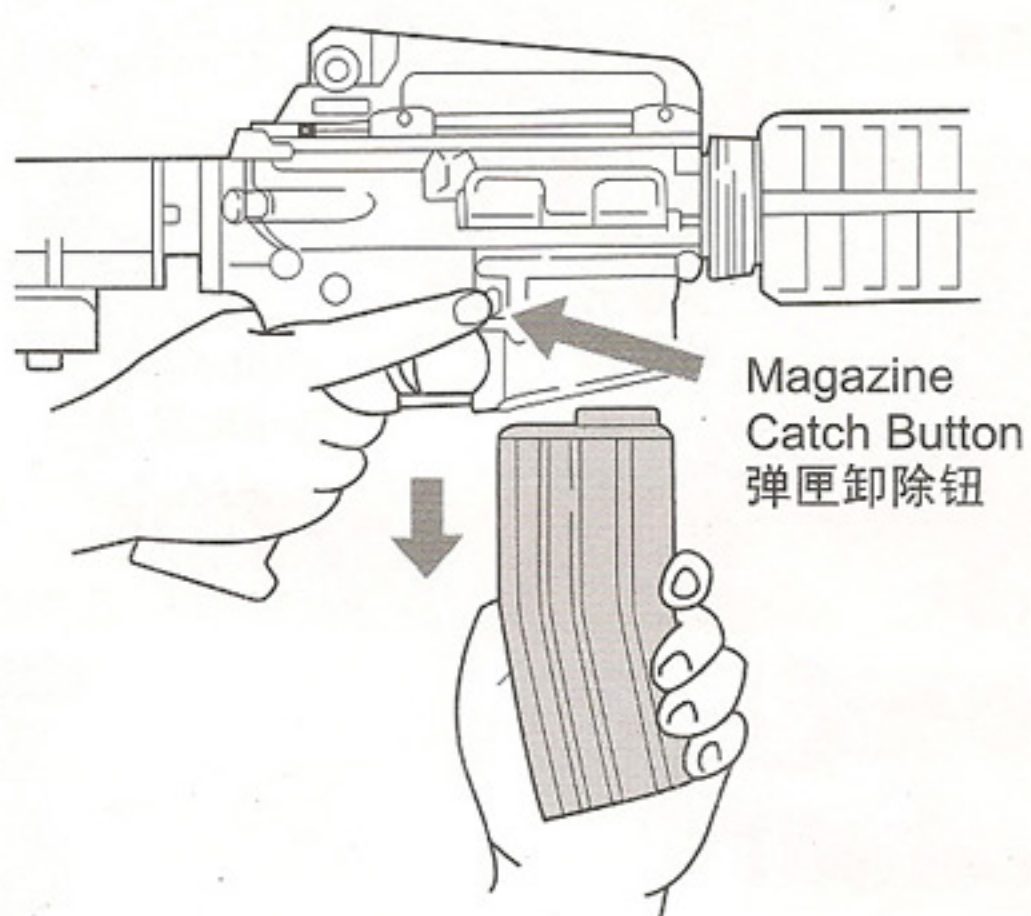

- ② Load the Bullets into the loader.  
(It can be loaded with about 40 bullets.)  
将子弹装入弹器内。(约40颗)

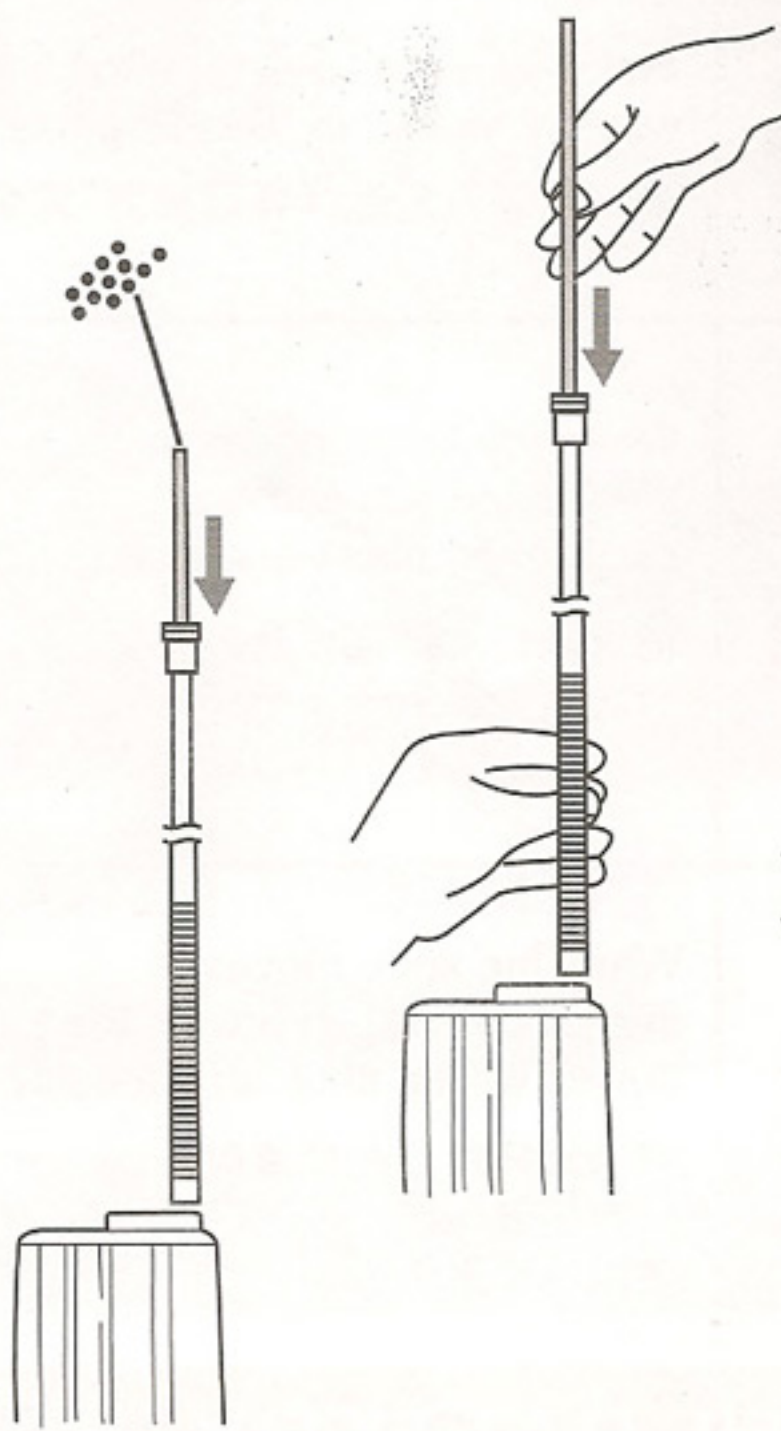

- ③ Push the bullets down using the Bullets Loading Rod. Do not pull magazine.  
用装弹棒将装弹器内的子弹推入弹匣内。注意不要过度用力。

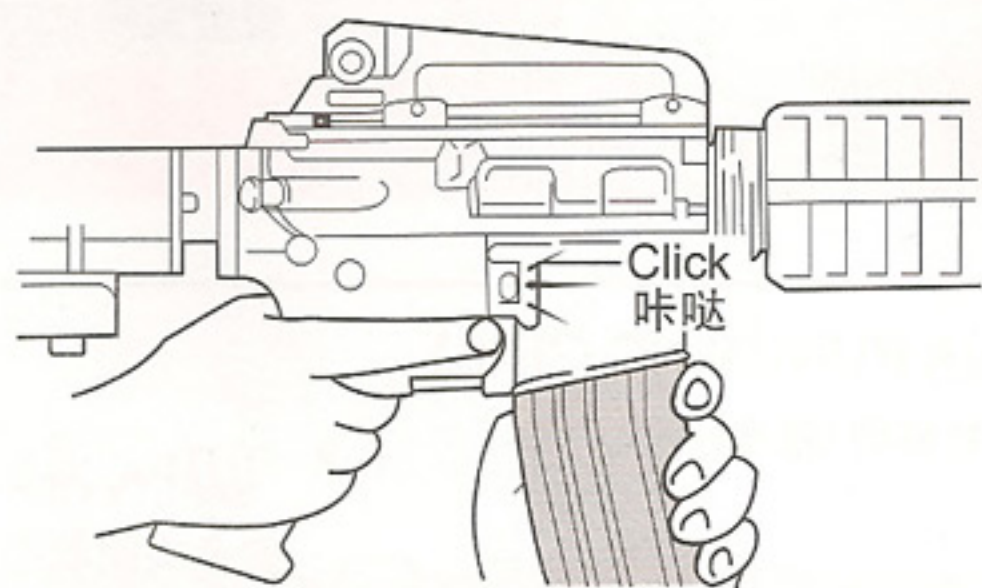

- ④ Install the magazine on the carbine till you hear the sound of "pata"  
把弹匣装在枪体上，直至听到“咔哒”一音。

## MAINTENANCE WHEN BULLET SPEED BECOMES LOW REMOVING CLOGGED BULLET

## 维护/疏通

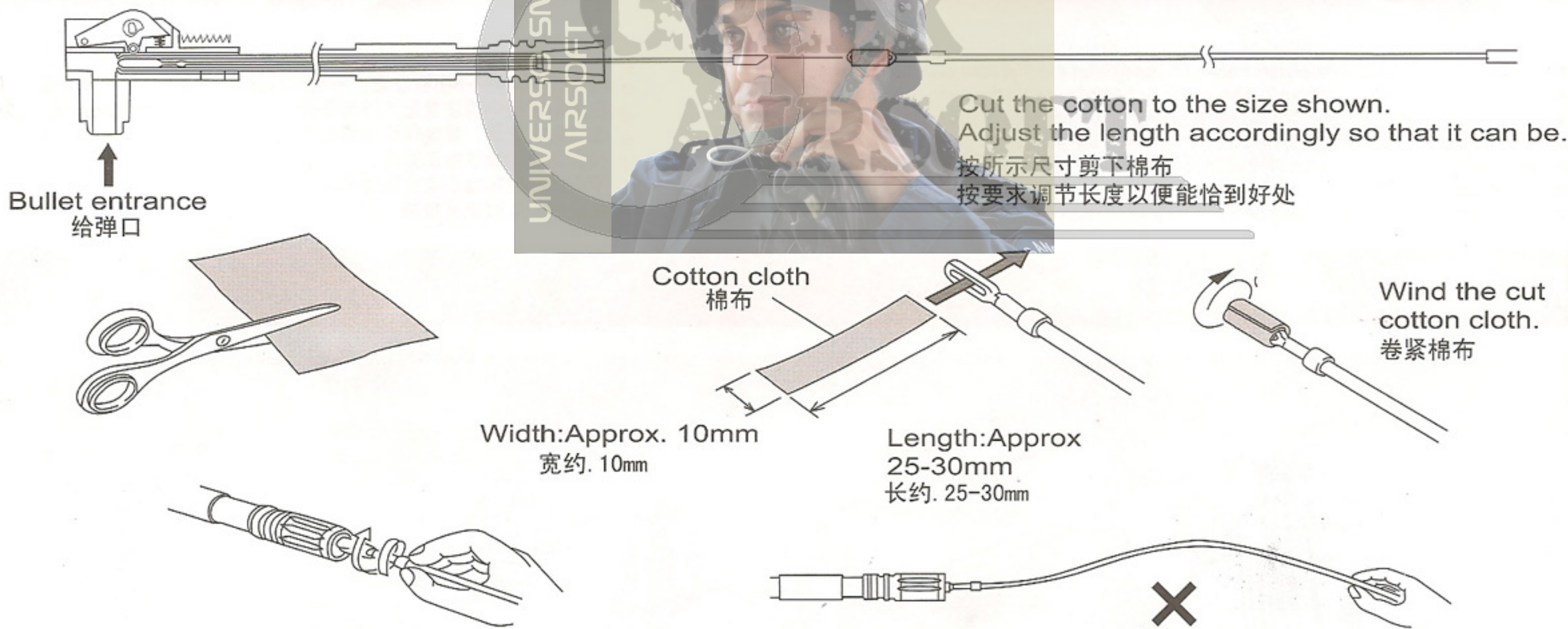

Hold at the leading end of the rod and insert the rod into the barrel while turning the rod.  
握紧疏导杆末端，在插入枪膛时一并旋转疏通杆

**注意** Inserting the rod will be difficult if you hold rod at the end.  
如果你抓住杆的末端，将会较难插入杆子

Insert the cleaning rod from the lead edge of the barrel.  
将清弹器从枪管的子弹边缘插入。

be careful so that the angled part of the cleaning rod faces down, and remove clogged bullets  
注意清弹器的尖角部分必须朝下，再取出阻塞的子弹。

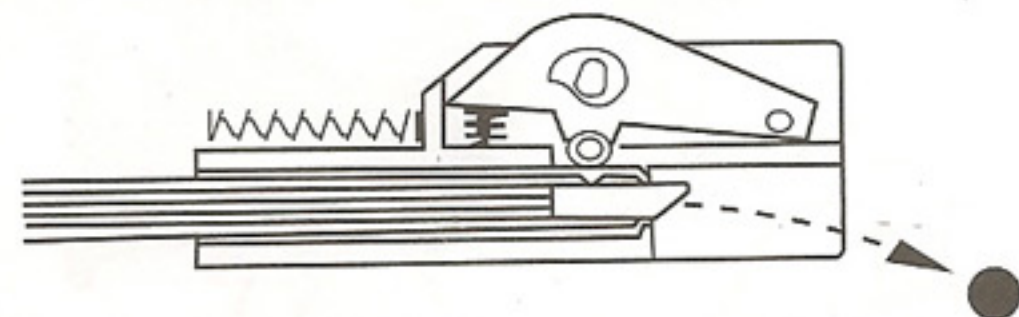
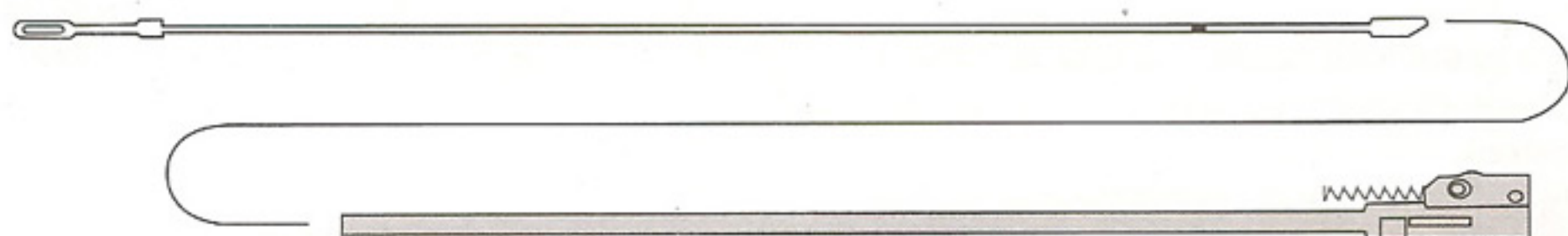

Make sure to clean the barrel chamber wherever bullets are removed  
子弹清除时一定要清洗枪膛



# SELECTOR LEVER AND SAFETY SETTING 单/连发及安全装置

# VERTICAL FORE GRIP ADJUSTMENT 前垂直握把调整方法

**SAFETY Setting**  
安全设定

SAFE

SAFETY ON  
安全开启状态

Make sure the knob for choosing shoot ways is moved to "SAFE" place.  
确定发射方式选择杆已拨到“安全”位置。

**SEMI(SINGLE FIRG)**  
半自动(单发)

SEMI

SAFETY OFF  
安全关闭状态

When the knob moves to this place, you can only shoot one bullet each time.  
把选择杆拨到此位置时, 一次只能发射一发子弹。

**AUTO(A RUNHNING GIRE)**  
全自动(连发)

AUTO

SAFETY OFF  
安全关闭状态

When the knob moves to this place, you just buckle the trigger, and the bullets will be shot continuously.  
把选择杆拨到此位置时, 只要扣着扳机, 子弹会被连续地发射出去。

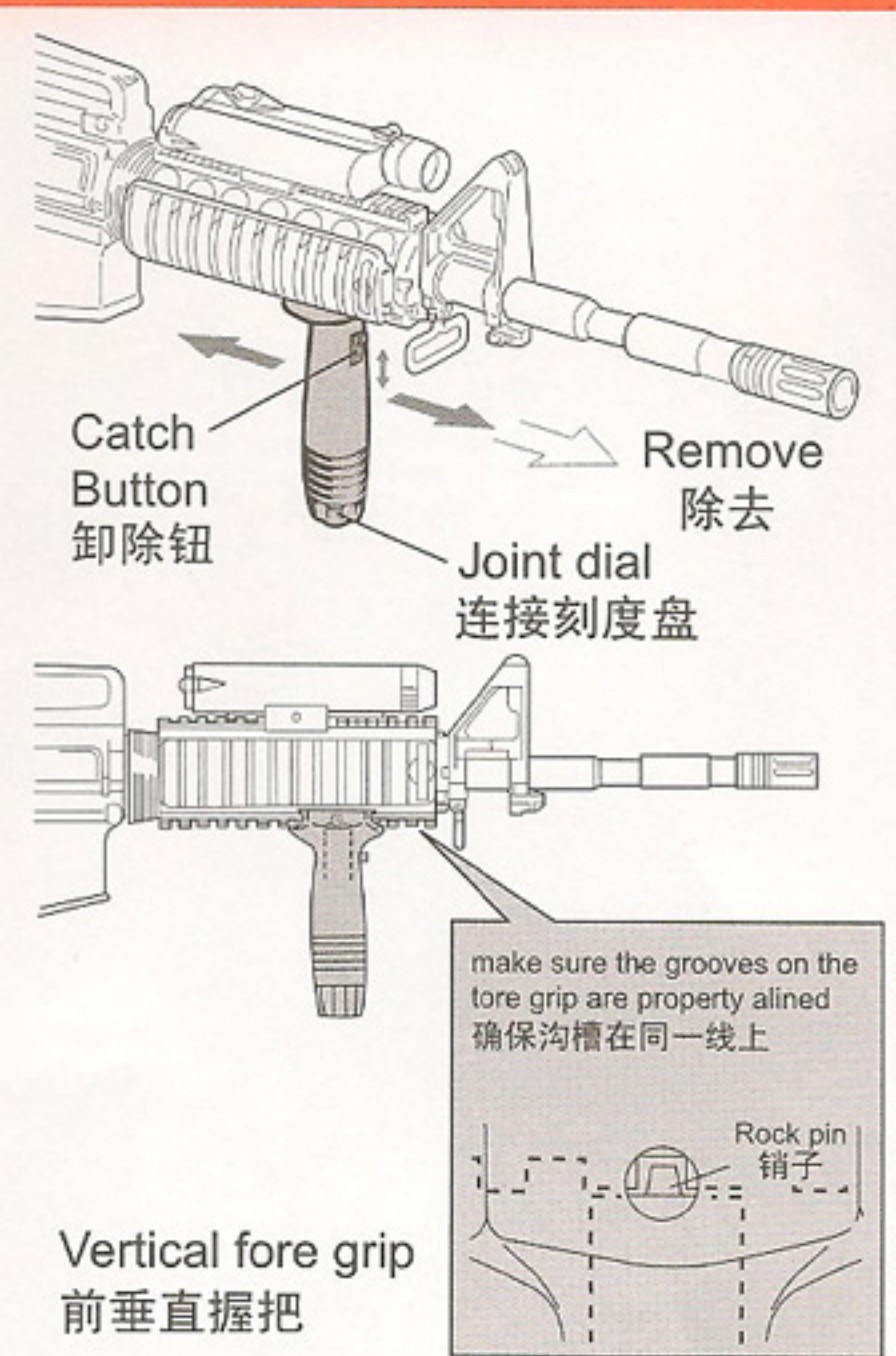

# CHARGE THE POWERFUL BATTERY 电池充电

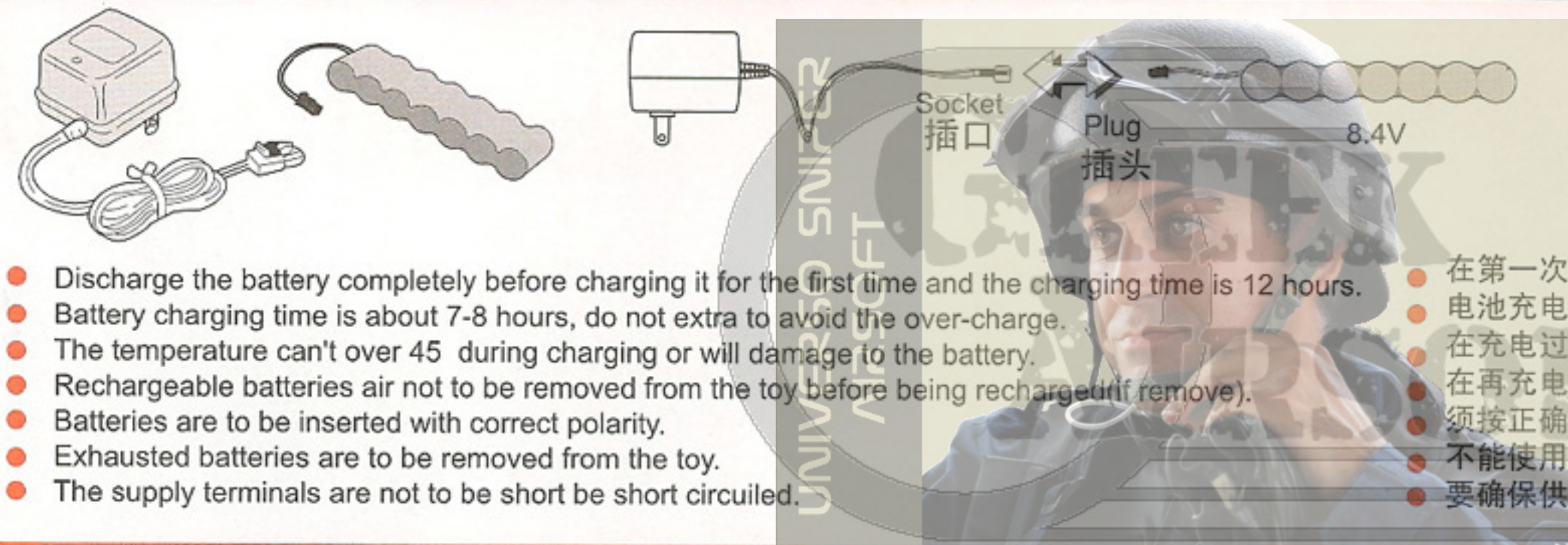

**Connect:** Press the battery plug to insert into the output socket of the charger till hear "crack".  
**连接:** 按住电池插头插入到充电器的输出插头中直到发出“咔哒”一声。

- Discharge the battery completely before charging it for the first time and the charging time is 12 hours.
- Battery charging time is about 7-8 hours, do not extra to avoid the over-charge.
- The temperature can't over 45 during charging or will damage to the battery.
- Rechargeable batteries air not to be removed from the toy before being recharged (if remove).
- Batteries are to be inserted with correct polarity.
- Exhausted batteries are to be removed from the toy.
- The supply terminals are not to be short be short circuiled.
- 在第一次充电前, 先将电池余电放净, 充电时间为12小时。
- 电池充电需要7-8小时左右, 不要超过这个时间, 以免过度充电。
- 在充电过程中请注意电池温度不得超过45度, 否则将损坏电池。
- 在再充电之前, 要确保电池没有与充电器分开。
- 须按正确的极性指示安装。
- 不能使用的电池必须立即丢弃。
- 要确保供电时没有短路。

# RETRACTABLE STOCK 伸缩托

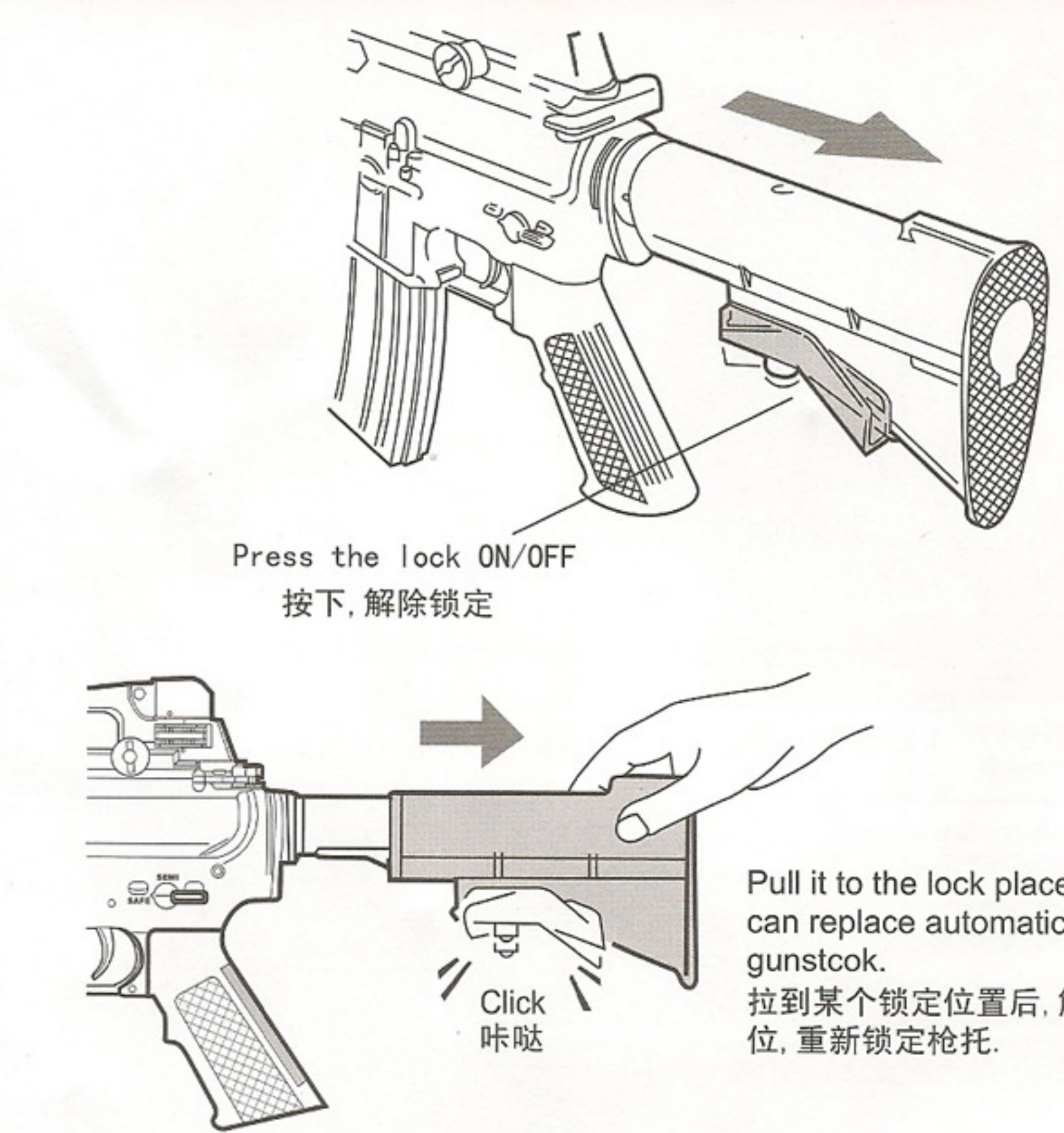

Adjust length of 4 position.  
长度有4种调节位置

最短位置 全长760mm  
Shortest Position

40mm

20mm (60mm)

20mm (80mm)

最长位置 全长840mm  
Longest Position

Adjust to the most comfortable position.  
调节至最舒服位置

Pull it to the lock place, the lock controller can replace automatically and relock the gunstock.  
拉到某个锁定位置后, 解锁控制杆会自动复位, 重新锁定枪托。



# TACTICAL 3 POINT SLING

三点式战术背带

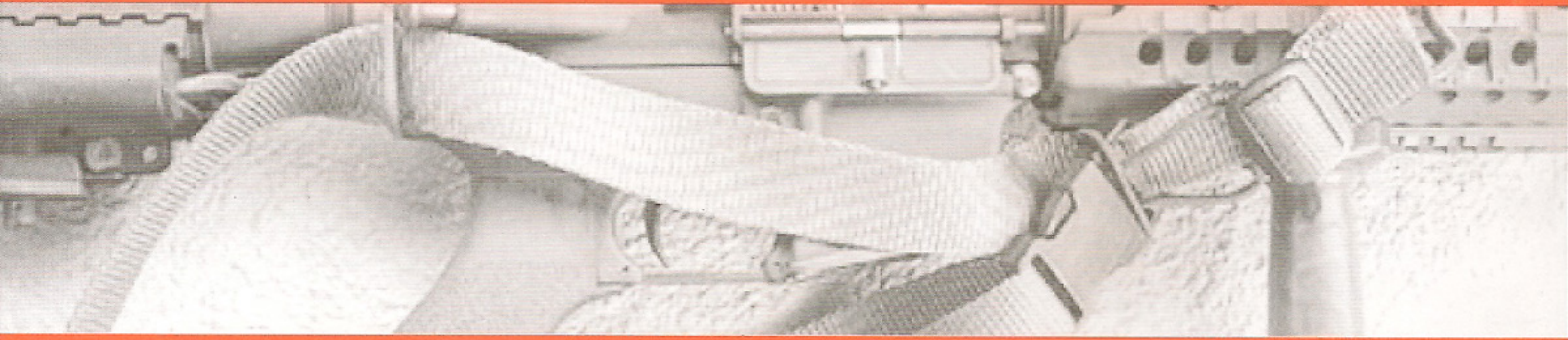

## PARTS 配置

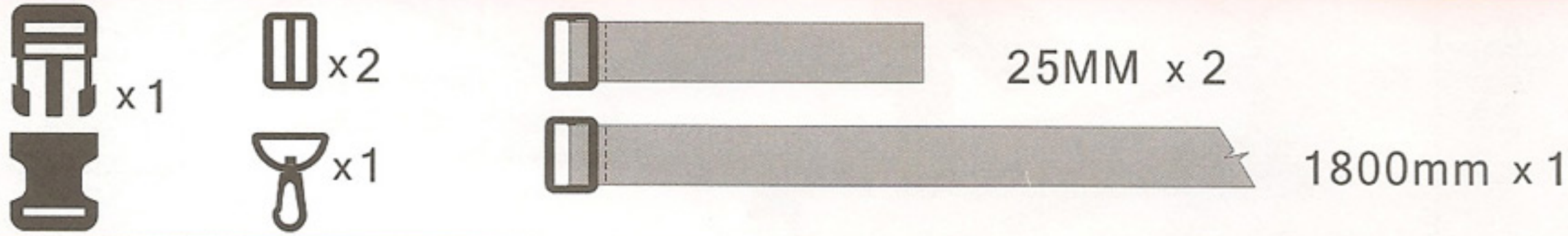

## SUGGESTED MODE 推荐模式

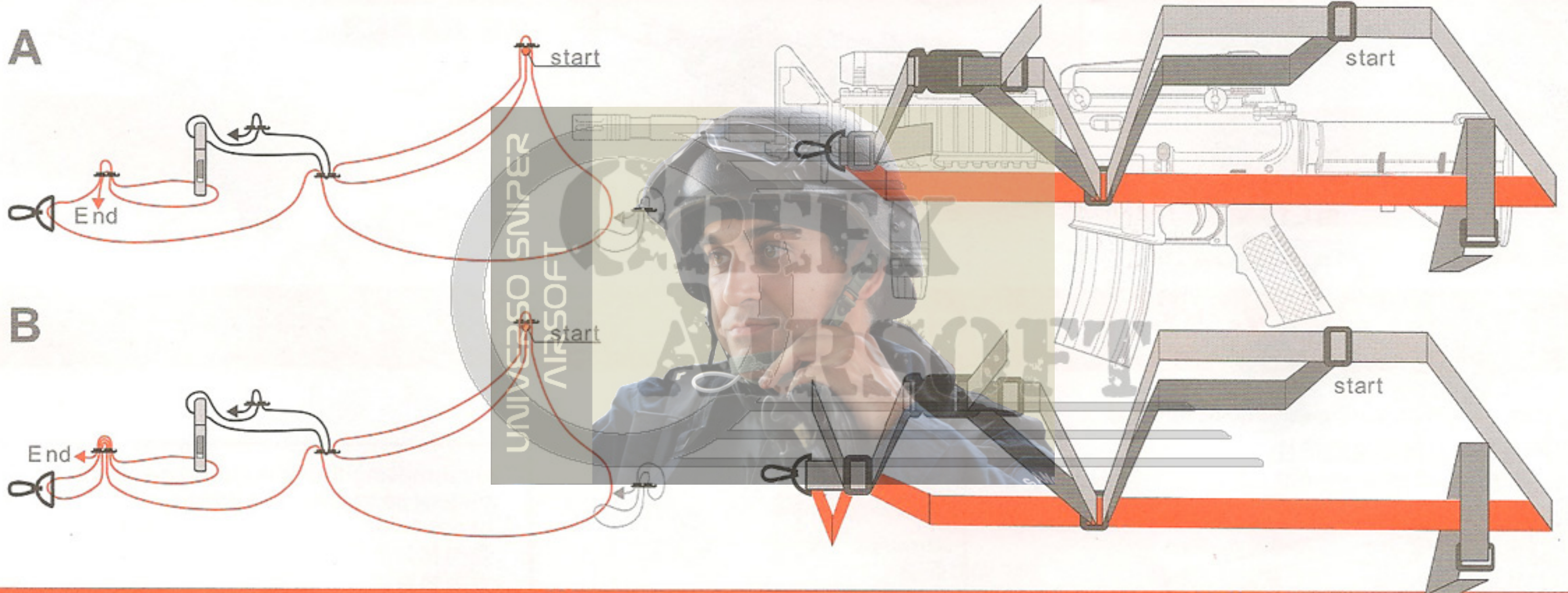

## QUICK BB LOADER 快捷上弹器

