



EVOLUTION AIRSOFT

LONE STAR TACTICAL SERIES

UNIVERSO SIMPER
AIRSOFT



VISPOLI
UNIVERSO SIMPER

INSTRUCTION MANUAL

MANUALE DI ISTRUZIONI
MANUAL DE USO

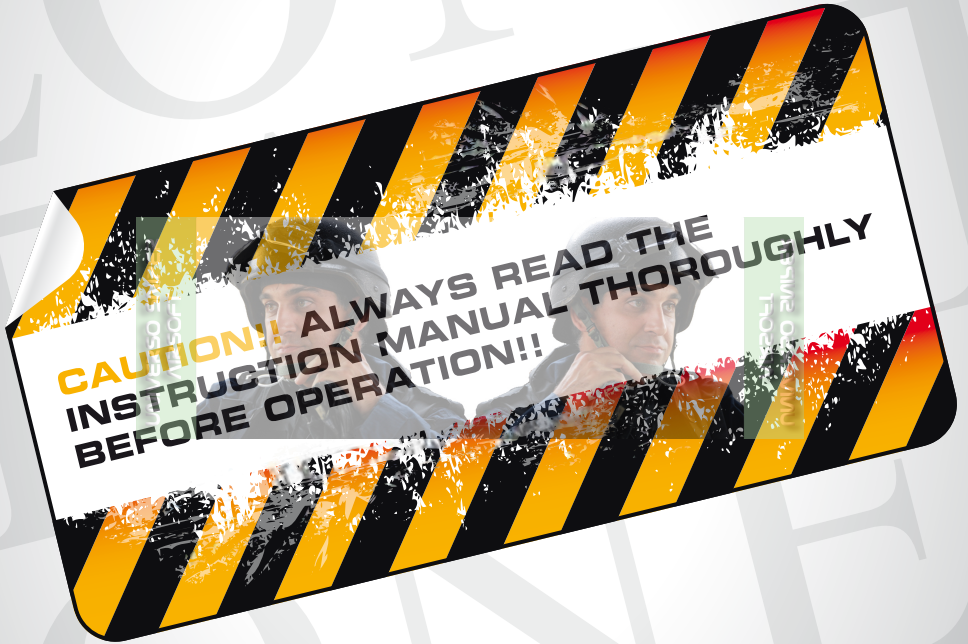



SERIES
INSTRUCTION
MANUAL

ENGLISH	P. 4
ITALIANO	P. 20
ESPAÑOL	P. 36

TABLE OF CONTENTS



MODELS	P. 5
LONE STAR TACTICAL SUPPLY	P. 6
BATTERY INSTALLATION	P. 8
OPERATION	P. 10
MAGAZINE	P. 11
SIGHT ADJUSTMENT	P. 12
HOP UP ADJUSTMENT	P. 14
MAINTENANCE	P. 15
WARNINGS	P. 16
TROUBLE SHOOTING	P. 18



EVOLUTION AIRSOFT

EVOLUTION AIRSOFT

LONE STAR SERIES MODELS



ENGLISH

LONE STAR BORDER PATROL



LONE STAR BORDER PATROL SBR



LONE STAR BORDER PATROL SWAT SBR



LONE STAR RANCHER



LONE STAR RANGER SBR



* Features and configuration may vary according to model and regions.

LONE STAR TACTICAL SUPPLY

Lone Star Tactical Supply, based in Texas, U.S.A., was founded by shooters for shooters. Founded by Dale Hunnicutt and Gary Burris, two avid shooters that brought to the firearms competitive market revolutionary products with the intention of giving 100% satisfaction with everything they offer.

Dale Hunnicutt:

One of the original founders and lead instructor of Tactical Trainers, a Houston & San Antonio based training organization specializing in tactical firearms training programs for competitive shooters, CHL holders, Law Enforcement and Military.

- NRA Certified Pistol instructor.
- 4 Gun Master in IDPA (International Defensive Pistol Association).
- Three Time Texas State IDPA Championship Match Director.



Gary Burris:

- Certified NRA Pistol, Rifle & Personal Protection Instructor.
- Certified IDPA Safety Officer Instructor.
- Certified Texas CHL Instructor.
- Training – Chapman Academy Advanced Handgun (Master).
- Training – Thunder Ranch Combat Handgun.
- Training – Tactical Trainers Competitive Handgun I, II & III.
- Training – Suarez International Rifle Gun Fighting & Urban Carbine.
- Training – Federal Bureau of Investigation (FBI) Citizens Academy.
- Twice Match Director of Louisiana State IDPA Championship.
- Eight Times Safety Officer at IDPA Nationals.

- Champion IDPA Shooter in six States.
- IDPA National & International Championship.

Together they have founded Lone Star Tactical Supply in order to share their combined knowledge of guns and shooting with shooters and Spec-Ops Operators around the world. This in hopes of making them better shooters and the world a safer place.



LONE STAR SERIES BATTERY INSTALLATION

1



Pull the delta ring back and **remove the handguard** from the rear.

2



Insert the battery in the handguard **as shown and connect the connectors**. Store the connectors **over the barrel as shown**.

3



Open the cover.

4



Insert the battery into the stock, **connect the connectors** and **close the cover**.

*** CAUTION!!** Be careful not to damage the wirings.

5

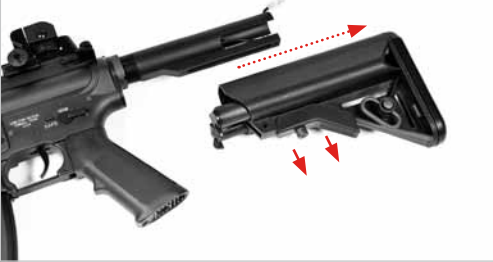

Pull the lever and slide back to remove the stock.

6



Remove the compartment caps from the stock. Connect the battery, insert the battery in the stock compartments and **reposition the stock on buffer tube.**

7



Push the two metal clips and pull down the handguard.

8



Insert the battery in the handguard **as shown and connect the connectors.** Store the connectors **under the barrel as shown.**

LONE STAR SERIES OPERATION



The selector lever allows **three positions:**

SAFE: safe on.



SEMI: semi auto.



AUTO: full auto.

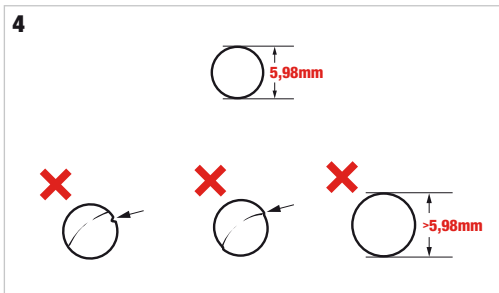

Use exclusively new BB pellets is a must. Do not use any BB pellet which is **not completed**, any **broken** BB pellet and any BB pellet which actual diameter exceeds **5,98mm**.

*** CAUTION!!** Never use any used BB pellets.

LONE STAR SERIES MAGAZINE



ENGLISH



Open the top hatch and insert the BB pellets, then **close the hatch**. The magazine capacity is **about 300 BB pellets**. (Avoid forcing BB pellets into magazine.)

* For the best performance the use of **Xtreme Precision®BB's** is recommended.



After having filled the magazine, **close the magazine door** and **rotate the gear** on it's bottom **till hearing a "click"**.



Insert the magazine in the receiver **as shown**.



After using the gun **always remove the magazine** pushing **the button** as shown.

* Always remember to **empty the magazine** pulling back the lever on it's top.

LONE STAR SERIES SIGHT ADJUSTMENT

1



To set the front sight to the point of impact **turn anti-clockwise to move up** the sight and **turn clockwise to move down** the sight.

*The front sight will come off **if turning too much**.

2



To set the rear sight to the point of impact **turn anti-clockwise to move left** the sight and **turn clockwise to move right the sight**. For rear sight **up or down adjustment** turn the wheel **clockwise to raise** the point of impact and turn **anti-clockwise to lower it**.

3

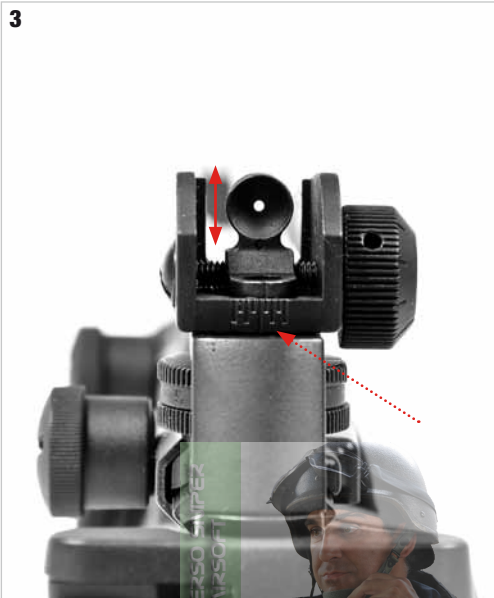

The sight assembly is **marked in millimeters** for easy use.

4

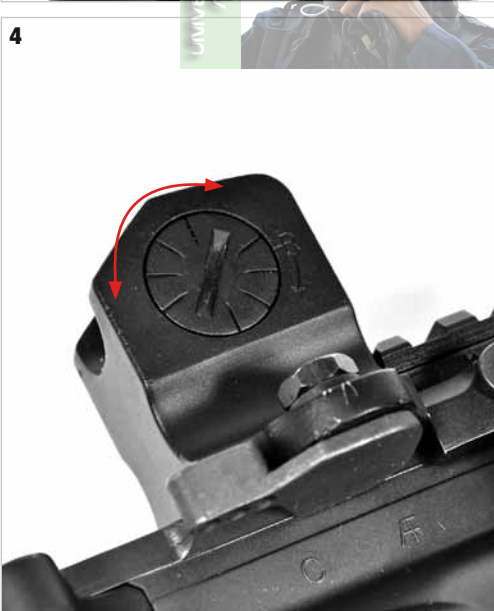

To set the rear sight to the point of impact **turn anti-clockwise to move left** the sight and **turn clockwise to move right** the sight.

HOP UP ADJUSTMENT



To adjust the Hop Up **pull the cocking lever** to lock the dummy bolt to **open position**.



To adjust the Hop Up **turn the gear clockwise** to increase the effect and **counter-clockwise** to decrease it.

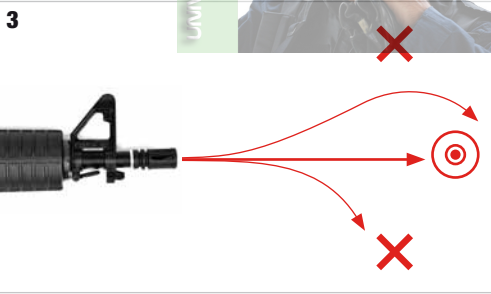

The proper setting of the Hop Up allows a **straight BB's trajectory** and the **maximum shooting distance** without any decrease of accuracy.



Press **the upper part** of the bolt catch lever **to release the dummy bolt**.

* Pay attention **not to release** the bolt catch lever **while adjusting the Hop Up**.

LONE STAR SERIES MAINTENANCE



1

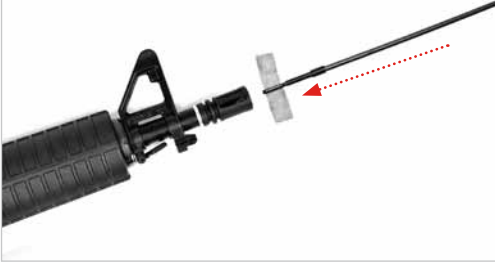

After **each use** always clean **the barrel** using a **cleaning rod** and a small piece of fabric, **soaked in spray silicone oil**.

2



In case of **defective BB's jammed** inside the barrel or in the Hop Up chamber, **immediatly stop firing**, adjust the Hop Up to minimum, **remove the magazine and use the unjamming rod** to push the clogged BB outside the Hop Up chamber feeding hole.

3

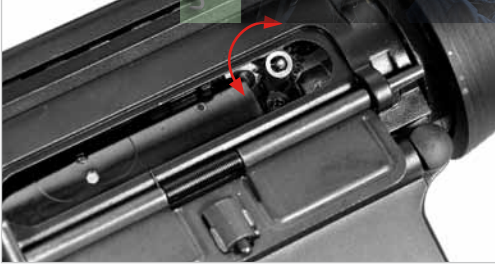

After **each use** set the Hop Up to zero **to release the stress on the Hop Up packing**.

4



After **50/60 thousand shots** ask a **qualified technician for a gun check up** and **replace** the worn out components. **Use exclusively Evolution Airsoft original replacement parts**.

WARNING!!

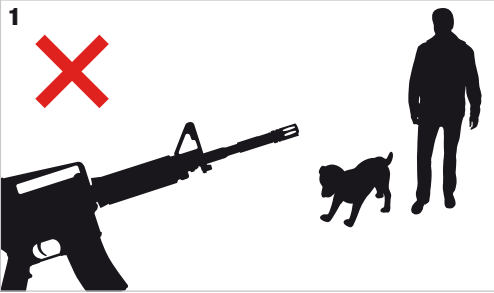

NEVER DIRECT THE MUZZLE TOWARDS PEOPLE AND ANIMALS.



NEVER PULL THE TRIGGER IF YOU DO NOT INTEND TO SHOOT.

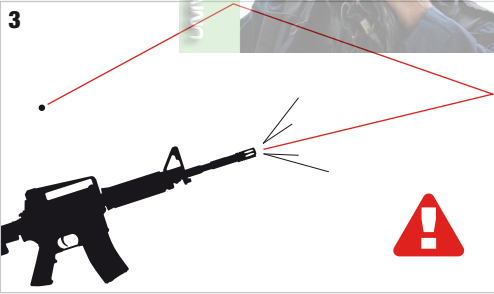

PAY ATTENTION TO BOUNCING BACK BB'S.



KEEP AWAY FOM CHILDREN.

WARNING!!



ENGLISH



NEVER LOOK INSIDE THE BARREL.



ALWAYS USE PROPER EYE AND FACE PROTECTION.



DO NOT DISASSEMBLE OR MODIFY THE GUN.

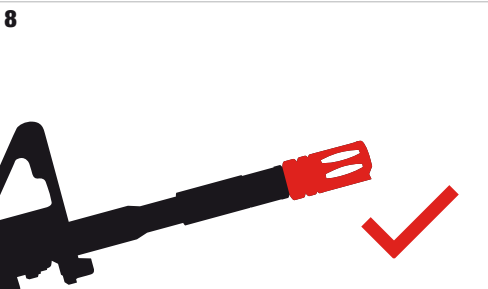

NEVER REMOVE THE RED/ORANGE COLOR FROM THE MUZZLE.

TROUBLE SHOOTING



SYMPTOM	POTENTIAL CAUSE	SOLUTION
No operation at all	Selector lever is set to SAFE.	Set the selector lever to FIRE or AUTO.
	Battery is not charged.	Charge the battery.
	Battery connector is disconnected.	Connect the connector correctly.
	Expired motor life (50,000/60,000 rounds).	Replace the exhausted motor (can be purchased from original original Evolution Airsoft spare parts dealers).
	Blown out fuse.	Change the fuse located in the battery compartment.
Although motor is revolving, no pellet can be fired	Pellets are clogged inside the magazine.	Empty the magazine, shake it and pull the lever to release the spring
	Pellets are clogged in the chamber.	Remove clogged pellets using the cleaning rod.
	Faulty gear or faulty piston.	Change the damaged gear with original Evolution Airsoft spare parts.
The motor tries to revolve but it can't	Insufficient battery power.	Charge the battery.
	Faulty BB pellets.	Use always BB pellets with 5.95 +/- 0.01 mm standard.
	Poor electrical connection.	Consult your dealer for maintenance or repair.
	The + and - of battery connector is reverse.	Connect the connector correctly.
Shooting distance becomes shorter	Damaged or worn out chamber set.	Change the damaged part with original Evolution Airsoft spare parts.
	The Hop Up is not adjusted.	Turn the Hop adjustment lever as shown in the manual.
	Damaged or worn piston set (O-ring, piston spring).	Change the damaged part with original Evolution Airsoft spare parts.
	The barrel is dirty.	Use the cleaning rod and clean the inner barrel.
	Faulty BB pellets (too small or too heavy).	Use always high quality BB's as the Xtreme Precision BB's.
	Shrotage of silicone oil.	Drop few drops of silicone oil spray in the chamber.
Too loud operating noise	Worn out or damaged gear.	Change the damaged gear with original Evolution Airsoft spare parts.
	Gear problem caused by too many blank firing.	Change the damaged gear with original Evolution Airsoft spare parts.
Pellets fall out from barrel end	Damaged or worn out chamber set.	Change the damaged part with original Evolution Airsoft spare parts.
	No Hop Up setting.	Turn the Hop Up adjustment lever as shown in the manual.
	Faulty BB pellets (too small).	Use always high quality BB's as the Xtreme Precision BB's.
If gun gets wet	Stop operation immediatly, disconnect the battery, wipe off water from inside the main body and the battery. After completely dry, carry out trial firing. If the unit is not operational, please contact your local dealer for repair.	

DISCLAIMER:

- ▲ Accessories pictured are **not always included** with product.
- ▲ Adult supervision required for users under 18 years of age.
- ▲ The seller and user should conform to all laws governing the ownership of airsoft guns.
- ▲ The Lone Star Tactical logo, Trademarks and Designs **are used under Worldwide Exclusive License from Lone Star Tactical Supply - U.S.A., by Evolution International S.r.l., Italy - ALL RIGHTS RESERVED.**
- ▲ Excessively long full auto bursts **may damage the mechanical components.**

FOR MORE INFORMATION AND UPDATES VISIT: www.evolution-airsoft.com

INFORMATION TO EU USERS:

The trash can symbol means that at the end of its life this product must be disposed of in compliance with the European Laws governing the disposal of electric and electronic waste.





UNIVERSO SNIPER
AIRSOFT

UNIVERSO SNIPER
AIRSOFT

LONE STAR TACTICAL SERIES MANUALE DI ISTRUZIONI

ENGLISH P. 4
ITALIANO P. 20
ESPAÑOL P. 36

INDICE CONTENUTI



MODELLI	P. 21
LONE STAR TACTICAL SUPPLY	P. 22
INSTALLAZIONE BATTERIA	P. 24
UTILIZZO	P. 26
CARICATORE	P. 27
REGOLAZIONE MIRE	P. 28
REGOLAZIONE HOP UP	P. 30
MANUTENZIONE	P. 31
PRECAUZIONI D'USO	P. 32
RISOLUZIONE PROBLEMI	P. 34



UNIVERSITÀ

UNIVERSITÀ

LONE STAR SERIES MODELLI



ITALIANO

LONE STAR BORDER PATROL



LONE STAR BORDER PATROL SBR



LONE STAR BORDER PATROL SWAT SBR



UNIVERSO SWIP
VMS CFT

UNIVERSO SWIP
VMS CFT

LONE STAR RANCHER



LONE STAR RANGER SBR



* La dotazione e la configurazione possono variare a seconda del modello o dei mercati.

LONE STAR TACTICAL SUPPLY

Lone Star Tactical Supply, con base in Texas, U.S.A., è stata fondata da tiratori per tiratori. Fondata da Dale Hunnicutt e Gary Burris, due avidi tiratori, che hanno portato sul competitivo mercato delle armi prodotti rivoluzionari con l'intenzione di dare agli utilizzatori il 100% di soddisfazione in qualunque loro prodotto.

Dale Hunnicutt:

Uno degli originari fondatori e capo istruttore della Tactical Trainers, un'organizzazione con base a Huston e San Antonio specializzata in programmi di addestramento per armi tattiche per tiratori competitivi, possessori di CHL, Law Enforcement e Militari.

- Istruttore Certificato NRA Pistol Instructor.
- 4 Gun Master in IDPA (International Defensive Pistol Association).
- Tre volte Texas State IDPA Championship Match Director.



Gary Burris:

- Istruttore Certificato NRA Pistol, Rifle & Personal Protection Instructor.
- Istruttore Certificato IDPA Safety Officer Instructor.
- Istruttore Certificato Texas CHL Instructor.
- Training - Chapman Academy Advanced Handgun (Master).
- Training - Thunder Ranch Combat Handgun.
- Training - Tactical Trainers Competitive Handgun I, II & III.
- Training – Suarez International Rifle Gun Fighting & Urban Carbine.
- Training – Federal Bureau of Investigation (FBI) Citizens Academy.
- Due volte Match Director Louisiana State IDPA Championship.
- Otto volte Safety Officer all' IDPA Nationals.

- Campione IDPA Shooter in sei Stati.
- Campione IDPA Nazionale ed Internazionale.

Insieme hanno fondato Lone Star Tactical Supply per condividere la loro conoscenza delle armi e delle tecniche di tiro con i tiratori e gli Operatori delle Forze Speciali di tutto il globo, nella speranza di fare di loro tiratori migliori e rendere il mondo un luogo più sicuro.



LONE STAR SERIES INSTALLAZIONE BATTERIA

1



Arretrare il delta ring e rimuovere l'impugnatura anteriore dalla parte posteriore.

2



Inserire la batteria come in figura e **collegare i connettori**.
Posizionare i connettori **sopra la canna** come in figura.

3



Abbassare la leva, aprire lo sportello ed **estrarre** il connettore.

4



Inserire la batteria **nel calcio**, **collegare i connettori** e **chiudere** lo sportello.

*** ATTENZIONE!!** Non **danneggiare** i cavi.

5

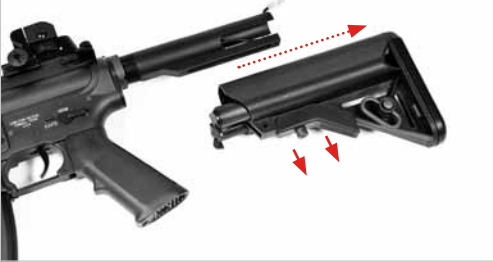

Per rimuovere il calcio **tirare la leva verso il basso e scorrere indietro.**

6



Rimuovere i tappi dal calcio, collegare la batteria, posizionarla all'interno dei vani e **ricollegare il calcio al buffer tube.**

7



Premere le due clip metalliche e tirare verso il basso.

8



Inserire la batteria come in figura e **collegare i connettori.** Posizionare i connettori **sotto la canna come in figura.**

LONE STAR SERIES UTILIZZO



Il selettore di tiro è regolabile su **tre posizioni:**

SAFE: sicura inserita.



SEMI: semi automatico.

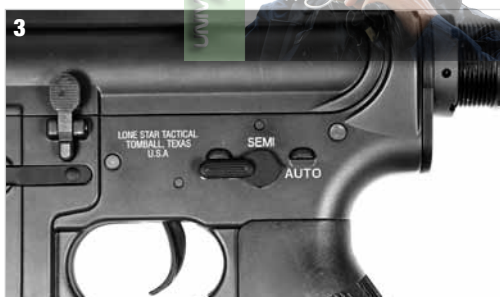

AUTO: raffica.

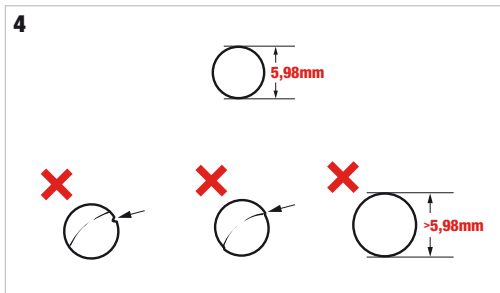

Utilizzare esclusivamente pallini nuovi. Non utilizzare pallini che presentano **parti non complete**, pallini **rotti** o con **diametro effettivo superiore a 5,98mm.**

*** ATTENZIONE!!** Non riutilizzare i pallini.

LONE STAR SERIES CARICATORE



ITALIANO



Aprire lo **sportello superiore**, inserire i pallini BB e **richiudere lo sportello**. La capienza è di circa **300 pallini**. (Non forzare l'inserimento dei pallini nel caricatore.)

* Per le **migliori prestazioni** si raccomandano i pallini **Xtreme Precision®**.

Dopo aver riempito il caricatore, **chiudere lo sportellino** e **ruotare la rotellina** posta sul fondo fino a sentire il **“click”**.



Inserire il caricatore nel fucile **come da illustrazione**.

Dopo l'utilizzo del fucile **rimuovere sempre il caricatore** premendo il **pulsante** sul fianco destro.

* Ricordarsi di **scaricare sempre** il caricatore **tirando la leva** posta nella parte superiore.

LONE STAR SERIES REGOLAZIONE MIRE



Per collimare il mirino anteriore con il punto d'impatto **ruotarlo in senso antiorario per alzare il mirino e in senso orario per abbassarlo.**

* Il mirino si sfilava se lo si fa **ruotare fino a fine corsa.**



Per collimare il mirino posteriore con il punto d'impatto **ruotarlo in senso antiorario per spostarlo a sinistra ed in senso orario per spostarlo a destra.** Per la regolazione in alto ed in basso del mirino posteriore ruotare la ghiera **in senso orario per alzarlo ed in senso antiorario per abbassarlo.**

3

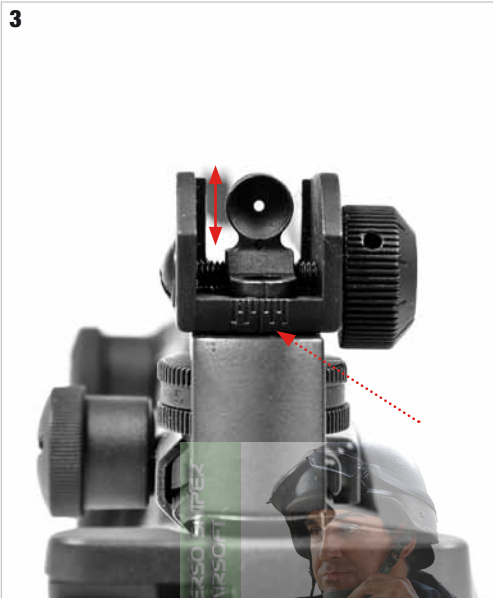

Il gruppo di mira è **graduato in millimetri** per un più facile utilizzo.

4

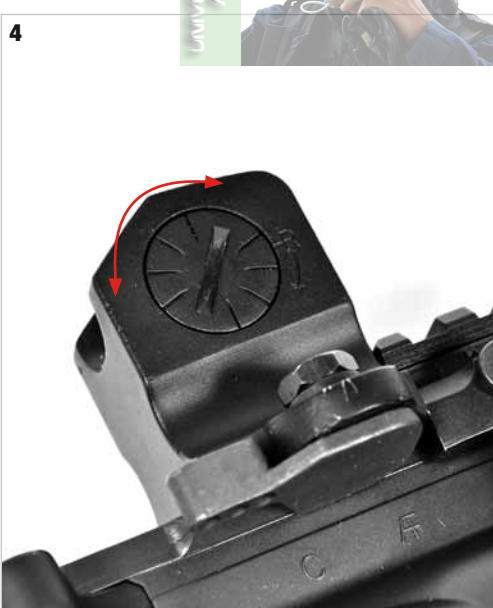

Per collimare il mirino posteriore con il punto d'impatto **ruotarlo in senso antiorario** per spostarlo a **sinistra** ed **in senso orario** per spostarlo a **destra**.

REGOLAZIONE HOP UP



Per effettuare **la regolazione** dell'Hop Up **tirare la leva di armamento per bloccare il finto otturatore in posizione arretrata..**



Regolare l'Hop Up tramite **l'apposita ghiera** ruotando **verso destra** per aumentarne l'effetto e **verso sinistra** per diminuirlo.

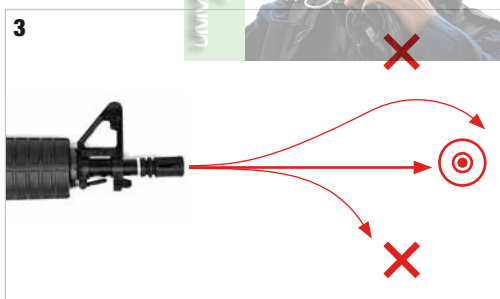

La regolazione ottimale consente di avere un **tiro teso** e la **massima gittata** senza perdite di precisione.



Premere **la parte superiore della leva bolt catch** per far **richiudere l'otturatore.**

* Fare attenzione a non **premere inavvertitamente** la leva bolt catch **durante la regolazione dell'Hop Up.**

LONE STAR SERIES MANUTENZIONE



ITALIANO

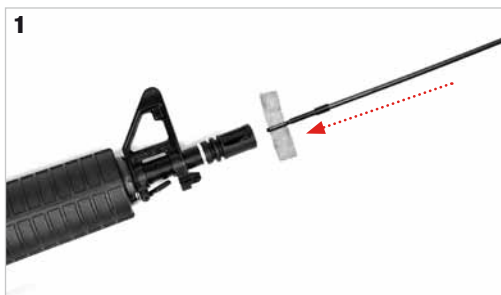

Dopo **ogni utilizzo** pulire **l'interno della canna** utilizzando **uno scovolo** avvolgendo all'estremità una striscia di stoffa imbevuta di **olio al silicone spray**.

In caso di **inceppamento di pallini difettosi** all'interno della canna o della camera dell'Hop Up **interrompere immediatamente** l'utilizzo, portare l'Hop Up in posizione di riposo, estrarre il caricatore **ed utilizzare lo scovolo** per estrarre il pallino inceppato dal foro di alimentazione dell'Hop Up.

Dopo **ogni utilizzo azzerare** la regolazione dell'Hop Up per portare il meccanismo **in posizione di riposo**.

Ogni **50/60mila colpi** far **revisionare** il fucile da un tecnico qualificato e **sostituire** le componenti consumate utilizzando **esclusivamente ricambi originali Evolution Airsoft**.

ATTENZIONE!!

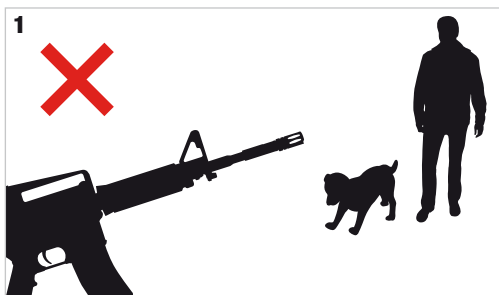

NON PUNTARE MAI LA CANNA VERSO PERSONE E ANIMALI.

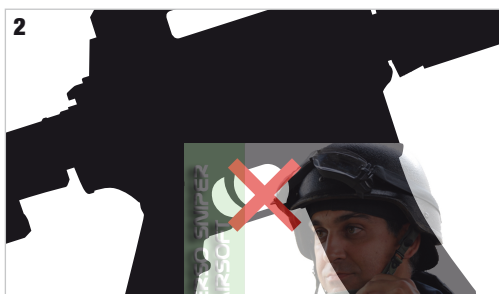

NON PREMERE MAI IL GRILLETTO SE NON SI INTENDE SPARARE.

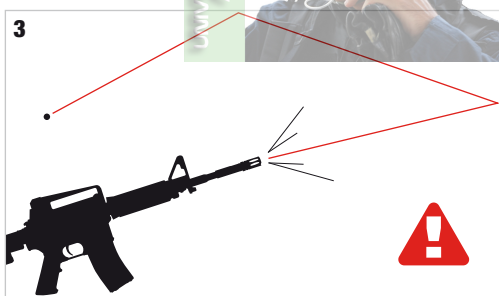

PRESTARE ATTENZIONE AI COLPI DI RIMBALZO.



TENERE LONATANO DALLA PORTATA DEI BAMBINI.

ATTENZIONE!!



ITALIANO



NON GUARDARE MAI DENTRO LA CANNA PER NESSUNA RAGIONE.



UTILIZZARE SEMPRE PROTEZIONI PER GLI OCCHI E PER IL VOLTO IDONEE.



NON SMONTARE O MODIFICARE IL FUCILE.

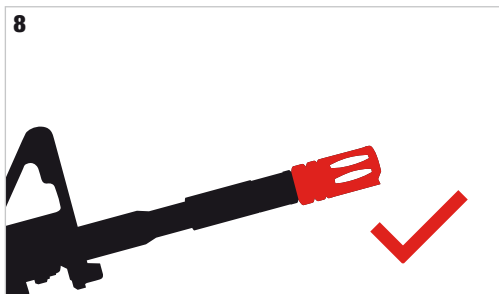

NON RIMUOVERE PER NESSUNA RAGIONE LA COLORAZIONE ROSSA DALLA VOLATA.

RISOLUZIONE PROBLEMI



SINTOMO	CAUSA	SOLUZIONE
Nessun funzionamento	Il selettore di fuoco è posizionato su SAFE. La batteria non è carica. I connettori + e - della batteria sono disconnessi. Il motore ha esaurito la sua vita utile (50.000/60.000 colpi). Fusibile guasto.	Posizionare il selettore di fuoco su SEMI o AUTO. Caricare la batteria. Collegare in maniera corretta i connettori. Sostituire il motore (che può essere acquistato da un rivenditore autorizzato di ricambi originali Evolution Airsoft). Cambiare il fusibile.
Anche se il motore gira, non viene sparato nessun colpo	I pallini sono incastrati nel caricatore. I pallini sono bloccati nel gruppo Hop Up o in canna. Gli ingranaggi o il pistone sono danneggiati.	Svuotare il caricatore, dare alcuni colpi con il palmo della mano sul fondo del caricatore e premere la leva di rilascio della molla Rimuovere i pallini utilizzando l'apposito scovolo. Sostituire le parti danneggiate con ricambi originali Evolution Airsoft.
Il motore cerca di girare ma non ce la fa	La carica della batteria non è sufficiente. Pallini difettosi. Insufficiente passaggio di corrente. I connettori + e - della batteria sono invertiti.	Caricare la batteria. Utilizzare pallini con standard 5.95 +/- 0.01 mm. Consultare un centro assistenza per la riparazione. Controllare che i connettori siano collegati correttamente.
La distanza di tiro è diminuita	Il gommino dell'Hop Up è danneggiato. L'Hop Up ha perso la regolazione. Il pistone è danneggiato. La canna è sporca. Si stanno utilizzando pallini sbagliati. Il fucile è poco lubrificato. Problemi agli ingranaggi causati da troppi spari a vuoto.	Sostituire le parti danneggiate con ricambi originali Evolution Airsoft. Regolare l'Hop Up seguendo le istruzioni. Sostituire le parti danneggiate con ricambi originali Evolution Airsoft. Usare l'apposito scovolo per pulire la canna del fucile. Usare solo pallini di alta qualità come i pallini Xtreme Precision BB. Mettere qualche goccia di olio al silicone spray nella camera dell'Hop Up. Sostituire le parti danneggiate con ricambi originali Evolution Airsoft.
Eccessivo rumore durante l'utilizzo	Gli ingranaggi sono danneggiati o rotti. Problemi agli ingranaggi causati da troppi spari a vuoto.	Sostituire le parti danneggiate con ricambi originali Evolution Airsoft. Sostituire le parti danneggiate con ricambi originali Evolution Airsoft.
Il pallino cade dalla canna senza sparare	Il gommino dell'Hop Up è rotto o danneggiato. L'Hop Up non è regolato. Si stanno utilizzando pallini troppo piccoli.	Sostituire le parti danneggiate con ricambi originali Evolution Airsoft. Regolare l'Hop Up seguendo le istruzioni. Usare solo pallini di alta qualità come i pallini Xtreme Precision BB.
Se il fucile si bagna	Smettere immediatamente di utilizzare il fucile e scollegare la batteria. Dopo averlo completamente asciugato, sparare alcuni colpi di prova. Se il fucile non funziona, contattare l'assistenza o il rivenditore per la riparazione.	

DISCLAIMER:

- ▲ Gli accessori raffigurati **non sono sempre inclusi** con il prodotto.
 - ▲ Per l'utilizzo da parte di minori di 18 anni è richiesta la supervisione di un adulto.
 - ▲ Il rivenditore e l'utente, per l'utilizzo del prodotto devono attenersi alle leggi locali.
 - ▲ Il nome ed il logo Lone Star Tactical, **sono marchi registrati di proprietà della Lone Star Tactical Supply, U.S.A.**, usati con licenza mondiale **esclusiva da Evolution International S.r.l., Italia.**
 - ▲ Raffiche eccessivamente prolungate **possono danneggiare** le parti meccaniche.
- PER MAGGIORI INFORMAZIONI O AGGIORNAMENTI: www.evolution-airsoft.com**

INFORMAZIONE AGLI UTENTI: Ai sensi dell'art. 13 del Decreto Legislativo 25 Luglio 2005, n. 151 "attuazione delle direttive 2002/95/CE e 2003/108/CE, relative alla riduzione dell'uso di sostanze pericolose nelle apparecchiature elettriche ed elettroniche, nonché allo smaltimento dei rifiuti".

Il simbolo del cassonetto barrato riportato sull'apparecchiatura o sulla sua confezione indica che il prodotto alla fine della propria vita utile deve essere raccolto separatamente dagli altri rifiuti. L'utente dovrà, pertanto, conferire l'apparecchiatura giunta a fine vita agli idonei centri di raccolta differenziata dei rifiuti elettronici ed elettrotecnici, oppure riconsegnarla al rivenditore al momento dell'acquisto di una nuova apparecchiatura di tipo equivalente, in ragione di uno ad uno. L'adeguata raccolta differenziata per l'avvio successivo dell'apparecchiatura dimessa al riciclaggio, al trattamento e allo smaltimento ambientale compatibile contribuisce ad evitare possibili effetti negativi sull'ambiente e sulla salute e favorisce il riempiego e/o riciclo dei materiali di cui è composta l'apparecchiatura. Lo smaltimento abusivo del prodotto da parte dell'utente comporta l'applicazione delle sanzioni amministrative previste dalla normativa vigente.





UNIVERSO SNIPER
AIRSOFT

UNIVERSO SNIPER
AIRSOFT

LONE STAR TACTICAL

SERIES MANUAL DE USO

ENGLISH	P. 4
ITALIANO	P. 20
ESPAÑOL	P. 36

INDICE CONTENIDOS



MODELOS	P. 37
LONE STAR TACTICAL SUPPLY	P. 38
INSTALACIÓN DE LA BATERÍA	P. 40
PROCEDIMIENTOS INICIALES	P. 42
CARGADOR	P. 43
MIRAS	P. 44
AJUSTE DEL HOP UP	P. 46
TRABAJO DE CUIDADO	P. 47
ADVERTENCIAS	P. 48
SOLUCIÓN DE PROBLEMAS	P. 50



LONE STAR SERIES MODELOS



LONE STAR BORDER PATROL



LONE STAR BORDER PATROL SBR



LONE STAR BORDER PATROL SWAT SBR



LONE STAR RANCHER



LONE STAR RANGER SBR



* La dotación y la configuración pueden cambiar de acuerdo con el modelo o los países.

LONE STAR TACTICAL SUPPLY

Lone Star Tactical Supply, con base en Texas, USA, ha sido fundada por tiradores para tiradores. Fundada por Dale Hunnicutt y Gary Burris, dos ávidos tiradores que han llevado al competitivo mercado de las armas productos revolucionarios, con la intención de dar a los usuarios el 100% de satisfacción sobre todos sus productos.

Dale Hunnicutt:

Uno de los fundadores y jefe instructor de la Tactical Trainers, una organización con base en Huston y San Antonio, especializada en programas de adiestramiento para armas tácticas de tiradores de competición poseedores de CHL, Law Enforcement y Militares.

- Instructor certificado NRA Pistol Instructor.
- 4 Gun Master en IDPA (International Defensive Pistol Association).
- Tres veces Texas State IDPA Championship Match Director.



Gary Burris:

- Instructor Certificado NRA Pistol, Rifle & Personal Protection Instructor.
- Instructor Certificado IDPA Safety Officer Instructor.
- Instructor Certificado Texas CHL Instructor.
- Training - Chapman Academy Advanced Handgun (Master).
- Training - Thunder Ranch Combat Handgun.
- Training - Tactical Trainers Competitive Handgun I, II & III.
- Training - Suarez International Rifle Gun Fighting & Urban Carbine.
- Training - Federal Bureau of Investigation (FBI) Citizens Academy.
- Dos veces Match Director Luisiana State IDPA Championship.
- Ocho veces Match Director Luisiana State.

- IDPA Championship Shooter en seis Estados.
- Campión IDPA Nacional e Internacional.

Juntos han fundado Lone Star Tactical Supply para compartir los conocimientos sobre las armas y las técnicas de tiro con tiradores y operadores de las Fuerzas Especiales de todo el globo con la esperanza de convertirlos en tiradores mejores y hacer del mundo un lugar más seguro.



INSTALACIÓN DE LA BATERÍA

1



Tirar el delta ring y remover el guardamanos desde atrás.

2



Insertar la batería en el guardamanos como en la imagen **y conectar los conectores.** Colocar los conectores **por encima del cañon** como en la imagen.

3



Bajar la palanca, abrir la tapa de la culata y **extraer** el conector.

4



Colocar la batería **en la culata, conectar los conectores** y **cerrar** la tapa.

*** ATENCIÓN!! No dañar** los cables.

5

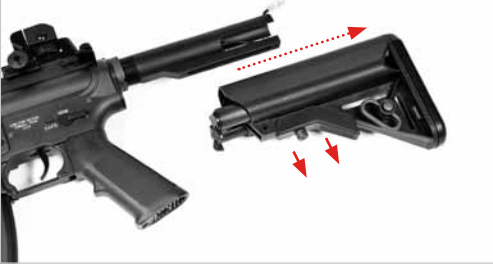

Para remover la culata **tirar la palanca hacia abajo y deslizar hacia atraz.**

6



Remover las tapas de la culata, conectar la batería y colocarla en la culata. **Reposicionar la culata como en la imagen.**

7



Apretar las clips y tirar hacia abajo.

8



Insertar la batería en el guardamanos como en la imagen **y conectar los conectores.** Colocar los conectores **debajo del cañon** como en la imagen.

PROCEDIMIENTOS INICIALES



El selector permite **tre modos**:

SAFE: seguro armado.



SEMI: tiro a tiro.



AUTO: ráfaga.

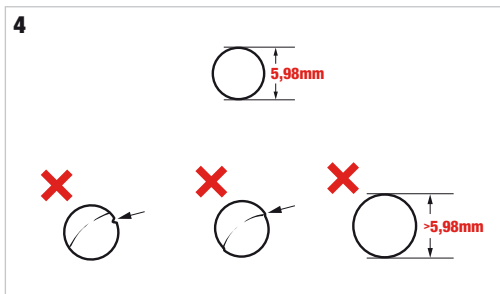

Usar **exclusivamente bolas BB nuevas**. No usar bolas BB imperfectas, rotas, o con un **diámetro efectivo mayor de 5,98mm**.

*** ATENCIÓN!!** No usar bolas BB usadas.

LONE STAR SERIES CARGADOR



ESPAÑOL



Abrir la ventanilla y cargar las bolas **sin forzar su entrada**.
La capacidad es de unos **300 BB'S**.

* Para **mejores resultados** recomendamos bolas **Xtreme Precision®**.



Después de haber llenado el cargador, **cerrar la ventanilla y girar la rueda** colocada sobre el fondo hasta escuchar **“click”**.



Colocar el cargador en el fusil **como en la imagen**.



Después el uso del fusil **quitar siempre el cargador** apretando **el botón sobre el costado derecho**.

* Acordarse de **descargar siempre** el cargador **tirando la palanca colocada en la parte de arriba**.

LONE STAR SERIES MIRAS



Para ajustar el punto de mira anterior con el punto de impacto **girar a la derecha e izquierda** como en la imagen.

* Girando demasiado **la mira se quita**.

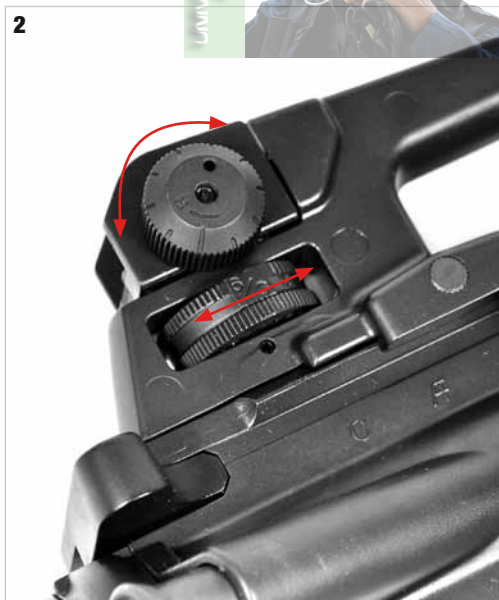

Para ajustar la mira trasera con el punto de impacto **girar la rueda a la izquierda y derecha**.

El alza se ajusta girando la rueda a la derecha **para subir el punto de impacto** y a la izquierda **para bajarlo**.

3

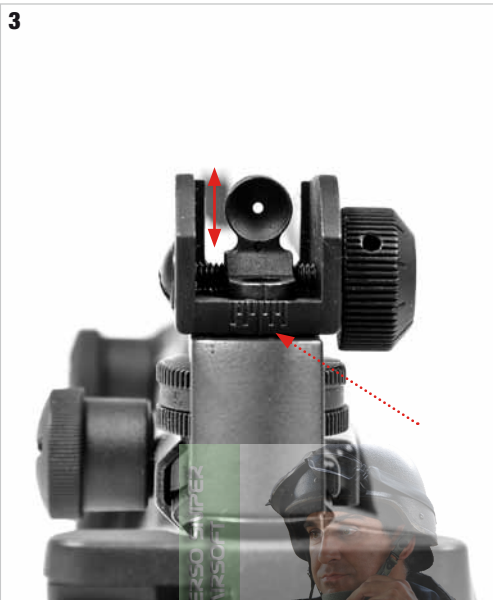

El grupo de mira **está indicado en milímetros** para un uso más fácil.

4

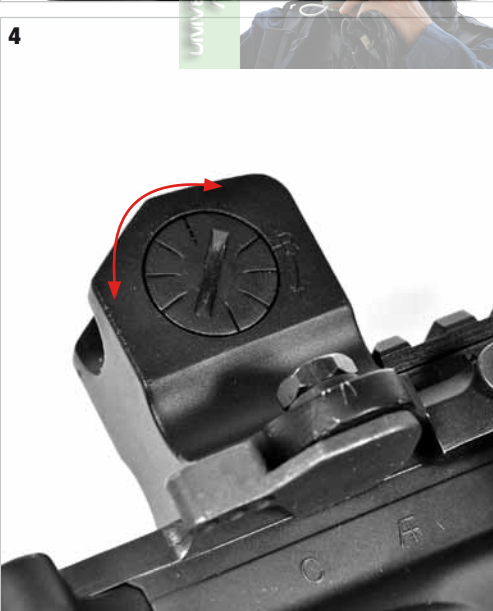

Para ajustar la mira trasera con el punto de impacto **gira la rueda a la izquierda y derecha.**

AJUSTE DEL HOP UP



Para **bloquear** el cerrojo en posición trasera **tirar la palanca de montar**.

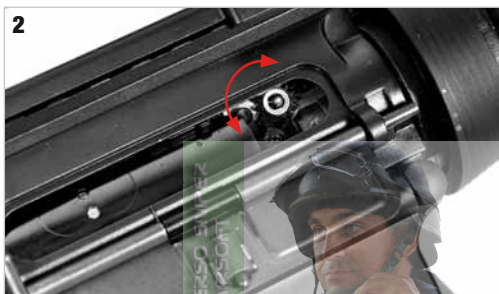

Ajustar el Hop Up mediante **su anillo girando hacia á la derecha** para aumentar el efecto y **hacia á la izquierda** para disminuir.

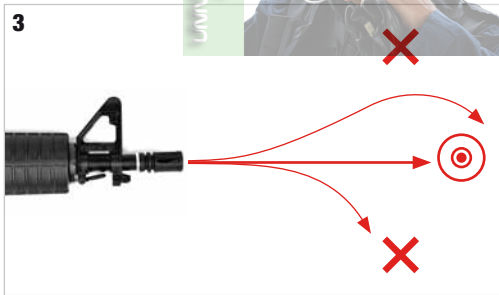

Un **perfecto ajuste** permite tener un **tiro tieso** y el **mayor alcance sin perder precisión**.



Apretar **la parte superior de la palanca** **bolt catch** para **cerrar el cerrojo**.

* Prestar atención a **no apretar por error** la palanca **mientras se ajusta el Hop Up**.

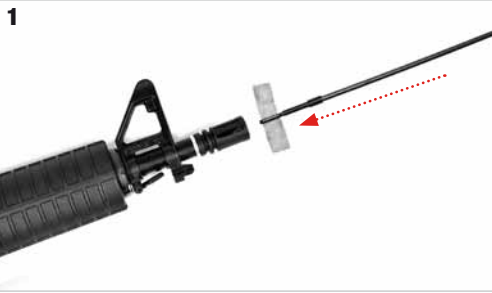

Después de **cada uso** limpiar **adentro del cañón** con un **cepillo** enroscando en la punta un trozo de trapo mojado con **aceite al silicon spray**.



En caso de **bolas defectuosas trabadas** dentro del cañón o del Hop Up **interrompir inmediatamente** el uso, colocar el Hop Up en descansa, quitar el cargador **y usar el cepillo** para quitar la bola trabada.



Después **de cada uso llevar** el Hop Up **en posición de descanso**.



Cada **50/60mil disparos** hacer **revisar** el fusil por un técnico y **cambiar** las piezas gastadas usando **solo recambios originales Evolution Airsoft**.

ATENCIÓN!!

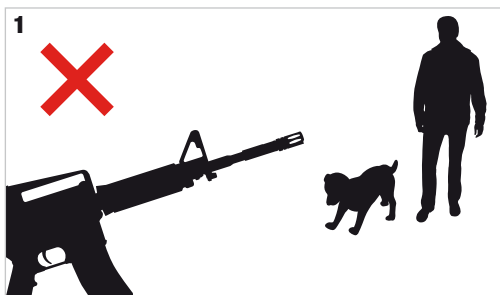

NO APUNTAR EL CAÑÓN HACIA PERSONAS O ANIMALES.

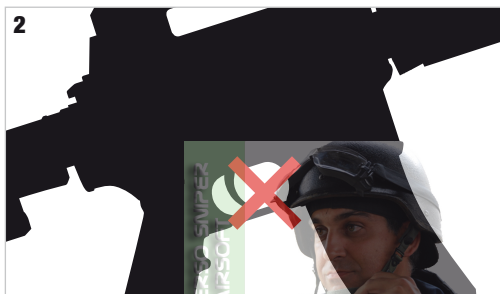

NO APRETAR NUNCA EL GATILLO SI NO SE DEBE DISPARAR.

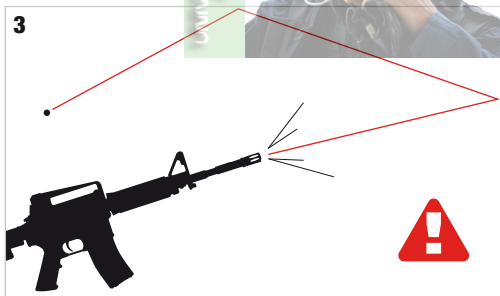

TENER CUIDADO CON LAS BOLAS DE REBOTE.



TENER LEJOS DEL ALCANCE DE LOS NIÑOS.

ATENCIÓN!!



ESPAÑOL



NO MIRAR DENTRO DEL CAÑÓN POR NINGUNA RAZÓN.



USAR SIEMPRE BUENAS PROTECCIONES PARA LOS OJOS Y EL ROSTRO.



NO DESMONTAR O MODIFICAR EL FUSIL.

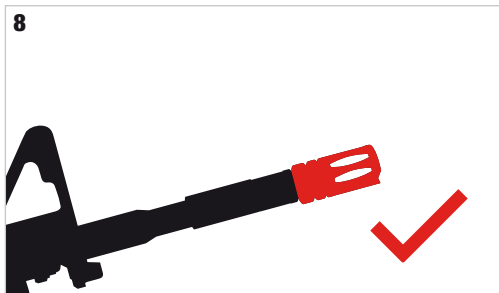

NO QUITAR POR NINGÚN MOTIVO EL COLOR ROJO DE LA BOCALHA.

SOLUCIÓN DE PROBLEMAS



SINTOMA	CAUSA	SOLUCIÓN
Ningún funcionamiento	El selector de tiro está en SAFE.	Poner el selector de tiro en FIRE u AUTO.
	La batería no está cargada.	Cargar la batería.
	Los conectores + y - de la batería están desconectados.	Conectar de manera correcta los conectores.
	El motor se ha agotado (50.000/60.000 tiros).	Cambiar el motor (puede ser comprado en un revendedor autorizado de piezas de recambio originales Evolution Airsoft).
	Fusible quemado.	Cambiar el fusible.
El motor gira pero no dispara	Las bolas están trabadas en el cargador.	Vaciar el cargador, dar algunos golpes con la palma de la mano sobre el fondo del cargador y apretar la palanca de liberación del muelle.
	Las bolas están trabadas en el grupo Hop Up o en el cañón. Un rodamiento o el pistón están dañados.	Quitar las bolas utilizando su correspondiente cepillo. Cambiar la pieza dañada con recambios originales Evolution Airsoft.
El motor trata de girar pero se traba	La batería no tiene carga suficiente.	Cargar la batería.
	Bolas defectuosas.	Usar bolas con standard 5.95 +/- 0.01 mm.
	Alimentación eléctrica insuficiente.	Consultar un centro de asistencia para reparación.
	Conectores + y - de la batería invertidos.	Conectar correctamente los conectores.
La distancia de tiro se ha acortado	La goma del Hop Up está dañada.	Cambiar la pieza dañada con recambios originales Evolution Airsoft.
	El Hop Up ha perdido su ajuste.	Ajustar el Hop Up.
	El pistón está dañado.	Cambiar la pieza dañada con recambios originales Evolution Airsoft.
	El cañón está sucio.	Usar su propio cepillo para limpiar el cañón.
	Se están usando bolas equivocadas.	Usar solo bolas de alta calidad como Xtreme Precision BB.
	El fusil está poco lubricado.	Colocar unas gotas de aceite de silicona spray en la recámara del Hop Up.
	Problemas a los rodamientos debidos a demasiados disparos en vacío.	Cambiar la pieza dañada con recambios originales Evolution Airsoft.
Demasiado ruido durante el uso	Los rodamientos están dañados o rotos.	Cambiar la pieza dañada con recambios originales Evolution Airsoft.
	Problemas a los rodamientos debidos a demasiados disparos en vacío.	Cambiar la pieza dañada con recambios originales Evolution Airsoft.
La bola cae del cañón sin disparar	La goma del Hop Up está rota o dañada.	Cambiar la pieza dañada con recambios originales Evolution Airsoft.
	El Hop Up no está bien ajustado.	Ajustar el Hop Up siguiendo las instrucciones.
	Se utilizan bolas demasiado pequeñas.	Usar solo bolas de alta calidad como Xtreme Precision BB.
Si el fusil se moja	Dejar inmediatamente de usar el fusil y desconectar la batería. Luego de haberlo secado completamente disparar algunos tiros de prueba. Si no funciona llamar el centro de reparaciones o el revendedor.	

DISCLAIMER:

- ▲ Los accesorios representados **no siempre están incluidos** con el producto.
- ▲ Para el uso por parte de menores de 18 años es necesario el control de un adulto.
- ▲ El revendedor y el usuario para el uso del producto están sujetos a las leyes locales.
- ▲ El nombre y el logo Lone Star Tactical y el design **son marcas registradas de propiedad de Lone Star Tactical Supply, U.S.A.**, usados con licencia mundial exclusiva por Evolution International S.r.l., Italia.
- ▲ Ráfagas demasiado largas **pueden dañar las partes mecánicas.**

PARA MAYORES INFORMACIONES Y ACTUALIZACIONES: www.evolution-airsoft.com

ATENCIÓN: El símbolo del cubo de la basura significa que este producto debe ser reciclado de acuerdo con las leyes europeas.





EVOLUTION AIRSOFT

UNIVERSO SMIPER
AIRSOFT

UNIVERSO SMIPER
AIRSOFT

Made in Hong Kong

www.evolution-airsoft.com

UNIVERSO SIMPER
AIRSOFT



UNIVERSO SIMPER
AIRSOFT

EVOLUTION AIRSOFT

Made in Hong Kong

www.evolution-airsoft.com