



VECTOR ARMS 1

Read Through Manual Before Use

Visit us at:

WWW.ECHO1USA.COM

-WARNING-

This AEG is FOR AGES 18 and above.

This AIRSOFT gun can cause serious injury if misused. Full face protection is required.

Please read through the MANUAL BEFORE USE to avoid damages and injuries.

ECHO 1 User Manual

It is your **RESPONSIBILITY** to know your local and state laws regarding the **OWNERSHIP, USE and TRANSPORT** of your airsoft gun. If you are unsure of the laws, contact your local law enforcement agency or state government.

- Wear full eye and face protection at all times when handling or using an airsoft gun.
- Always keep your airsoft gun pointed in a safe direction.
- Always keep your airsoft gun unloaded until ready to use.
- Always keep your finger off the trigger until you are ready to shoot.
- Know your target and what is beyond it.
- Know how to operate your airsoft gun. (Refer to your owners manual)
- Use only the recommended BB's in your airsoft gun.
- Never use alcohol or over the counter, prescription or other drugs before or while shooting your airsoft gun.
- Store airsoft guns so they are not accessible to unauthorized persons.
- Make sure your airsoft gun is unloaded and battery has been removed prior to cleaning and storage.

Parts of the Gun

VECTOR ARMS 1



Specs of the Gun

Name of Gun	VECTOR ARMS 1
Weight	6.5lb
Barrel Length	247mm
Overall Length	640mm
Barrel Caliber	6.08mm
BB Capacity	200BB
BB Size	6mm
Feet Per Second	400-410fps
Battery Type	8.4v Large

Selector Modes

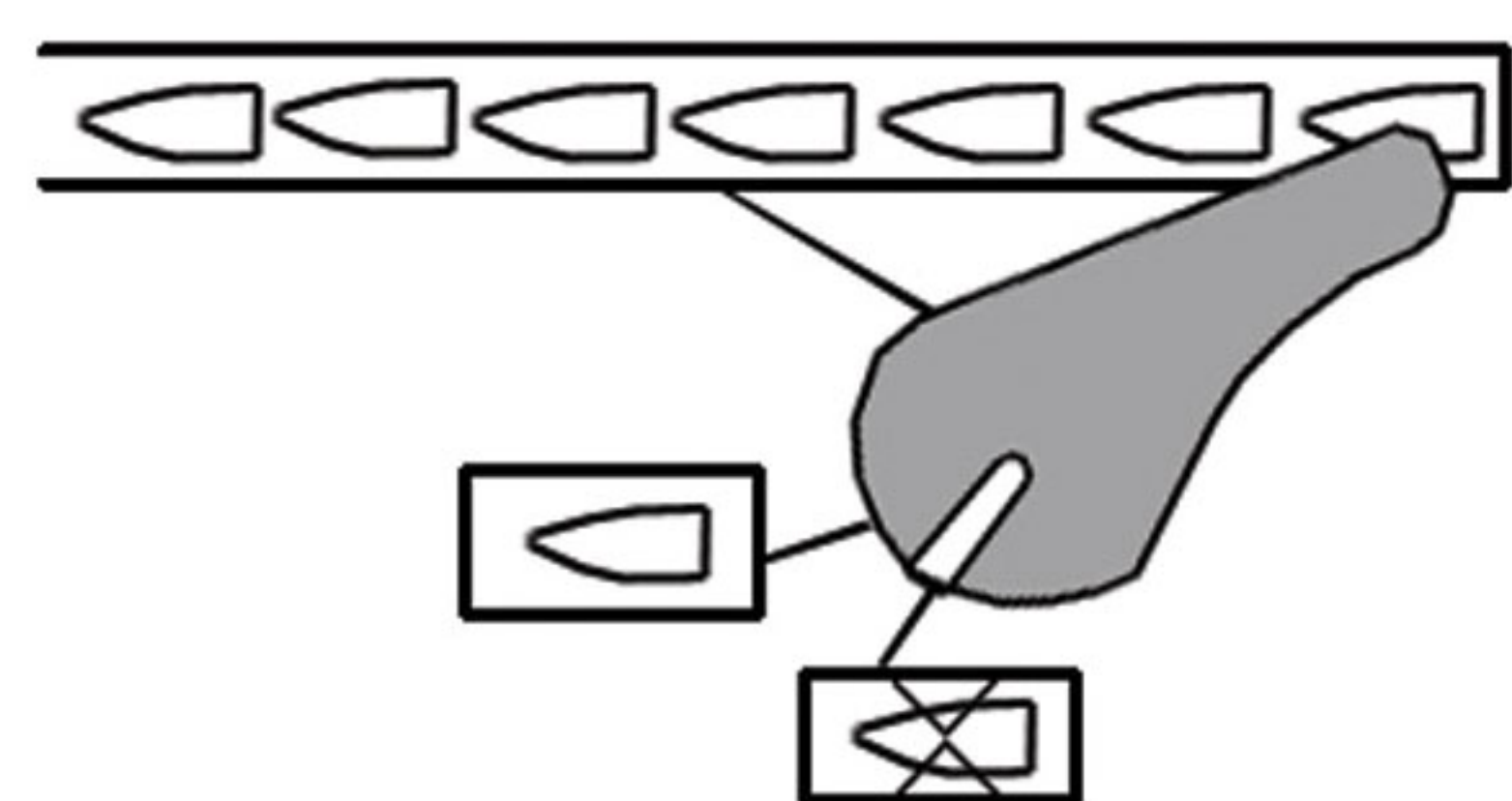

SAFE:

Trigger is secure and should not fire.

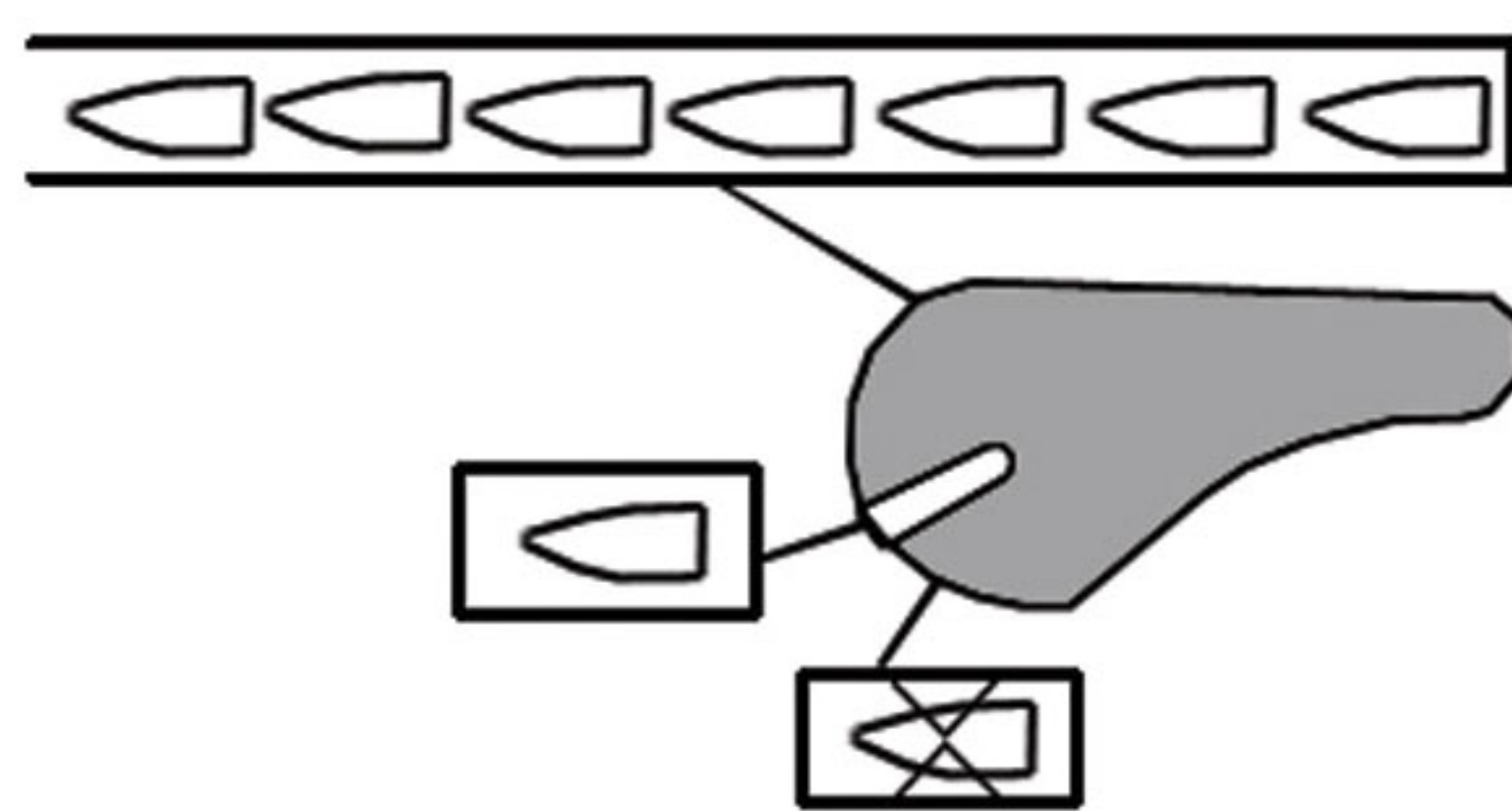

SEMI:

One BB will fire with each trigger pull.

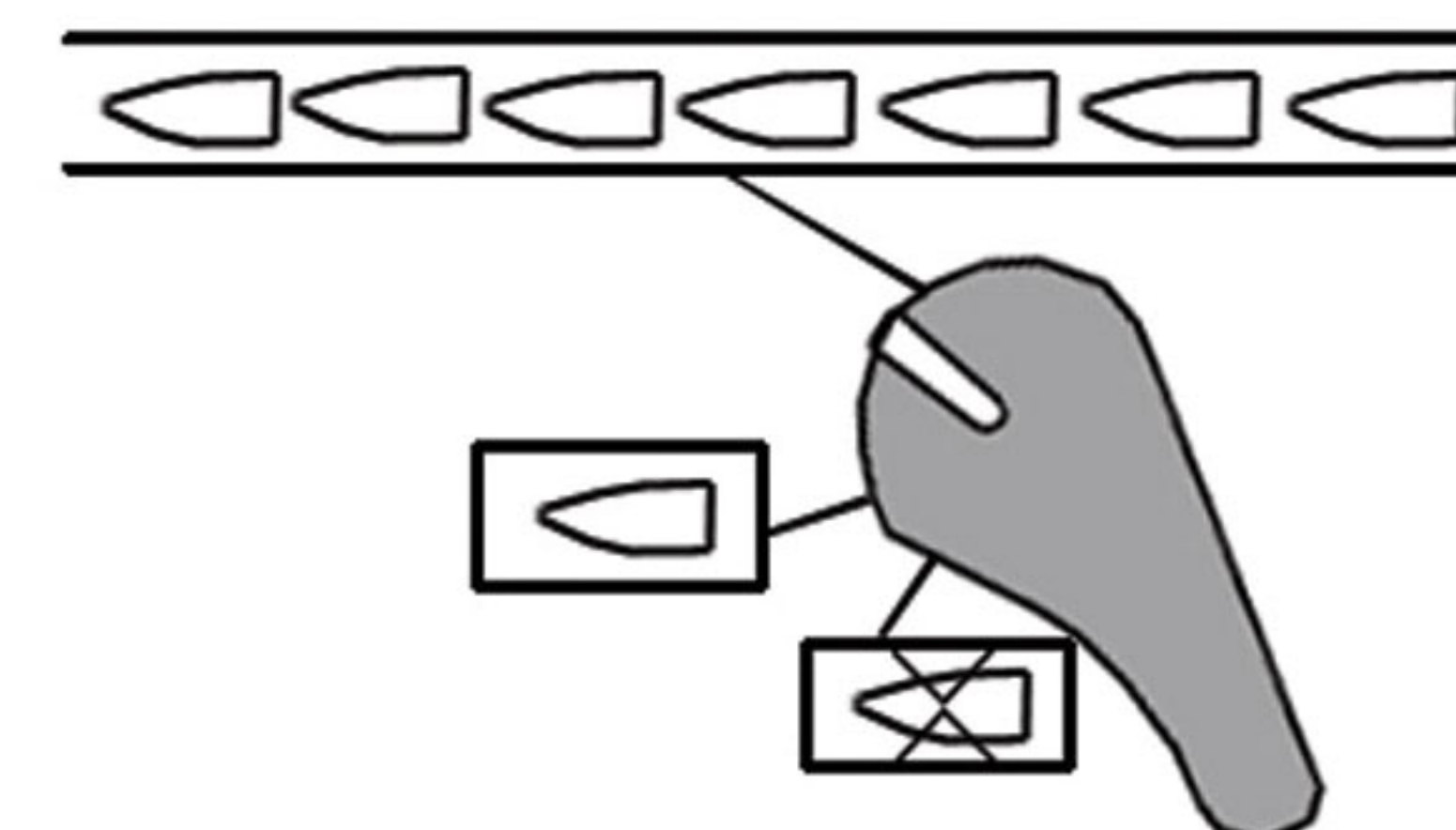

AUTO:

Gun will fire continuously while trigger is pulled.

The Battery

Charge the battery for 3 hours for the first time. When charging have the battery away from ALL COMBUSTABLE MATERIALS and on cool hard surface. If battery becomes HOT remove from charger and let it COOL before use. When cycle rate becomes slow, STOP shooting and remove magazine. Shoot 2 times in SEMI to clear the gun, remove battery and recharge.

Connector
Battery
Stock pad

1. Press the stock pad down then pull away from gun.

2. Install battery. Make sure the connector is secure.

3. Gently push the wires back into the stock. Do not pinch the wires.

4. With the wires and battery inside the stock, gently slide the pad back in place.

* Keep the wires and fuse holder on the bottom.

How to use the Magazine

Avoid getting dirt and debris into the magazine this can cause it to malfunction.

Tips for operation:
Use caution when mag seems empty.
There are 30 bb's left in the loading tube.
Wind/Turn the gear approximately 7-10 times, every 30-50 bb's fired.

1. Press the magazine release to remove the magazine.

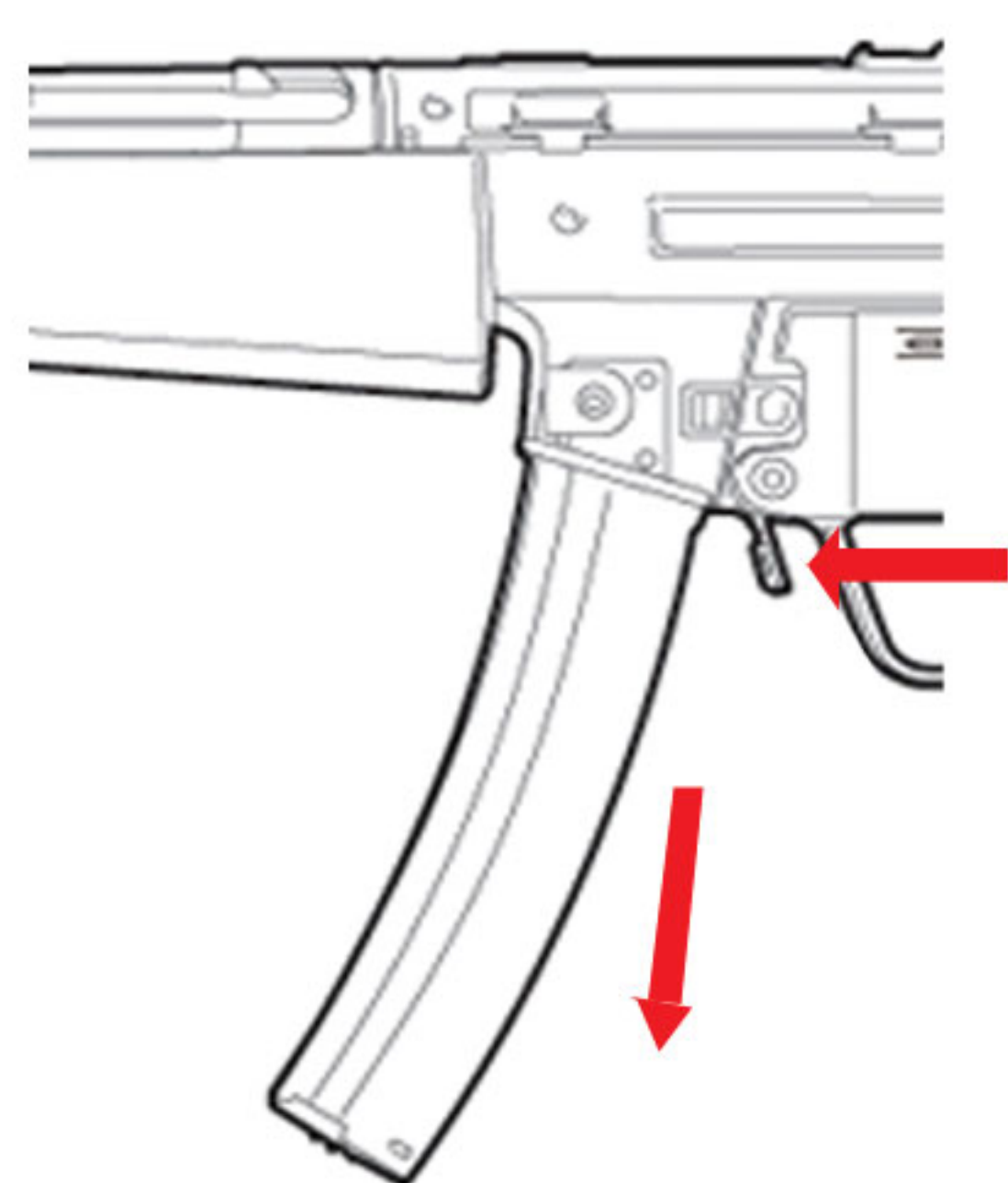

2. Open the top hatch and pour bb's. About 200 bb's can be loaded, do not force bb's.

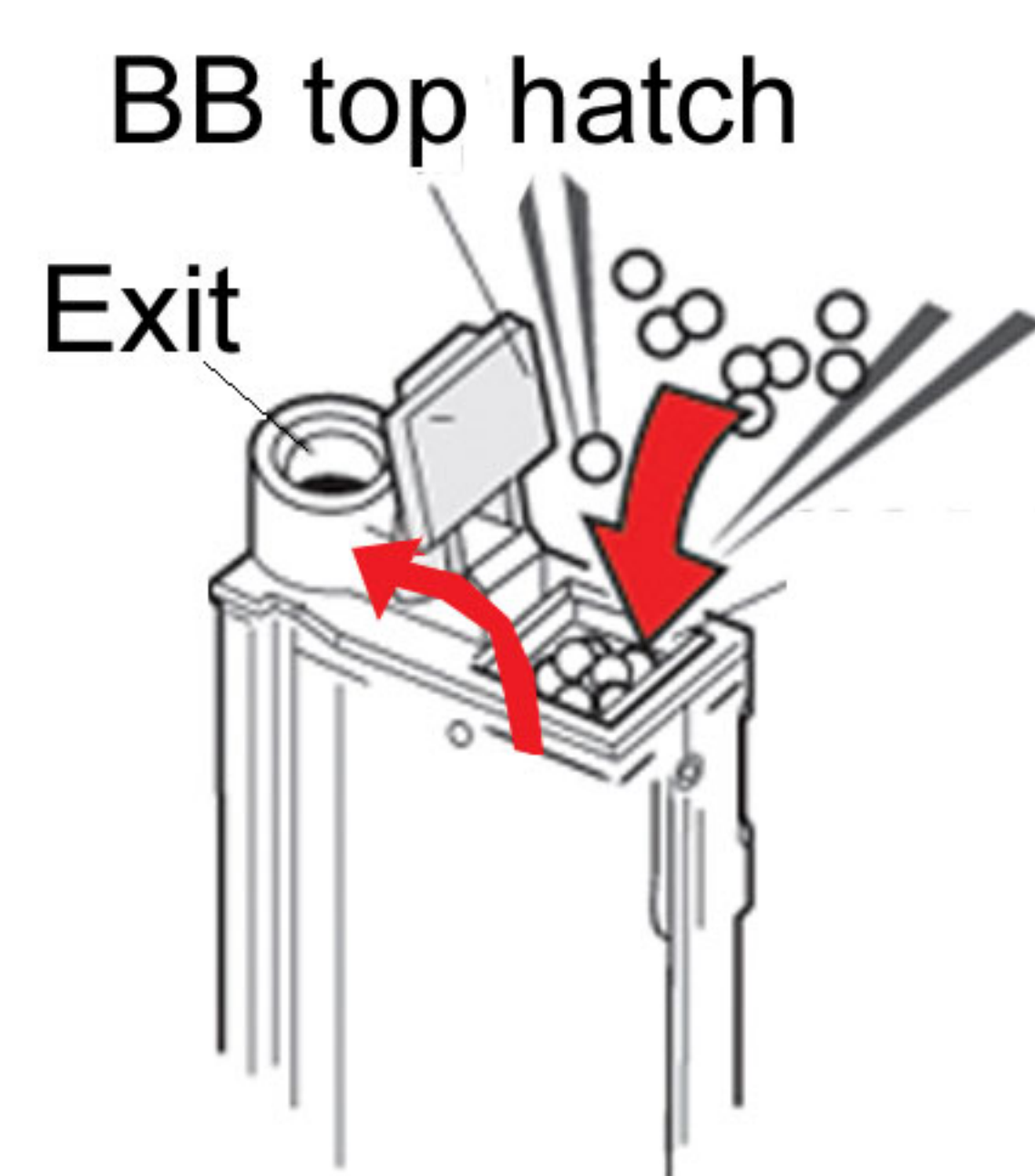

3. Close the hatch.

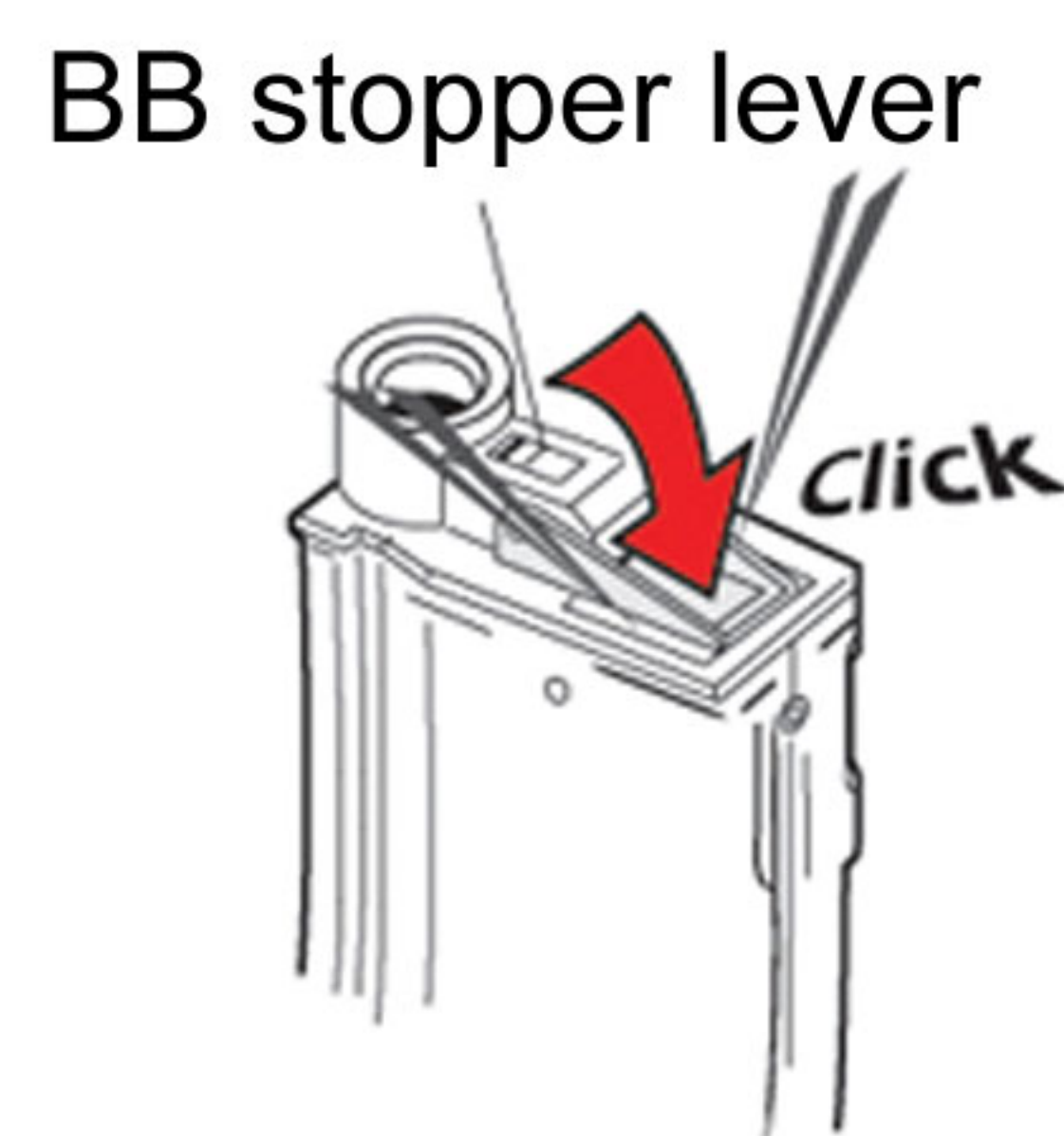

4. Hold the mag with the BB top hatch facing up and turn the gear. You will see BB move to the stopper lever. Once BB's have reached stopper lever continue to wind magazine for approximately 15 more turns.



Turn/Wind this GEAR

For storage release the remaining BB's to ensure correct operation next time, by pulling gently back on the BB stopper lever.

Adjusting the Hop Up

When adjusting the hop up make sure your shooting area is clear and safe to shoot.
If the hop up is too high it may jam and damage the gun.

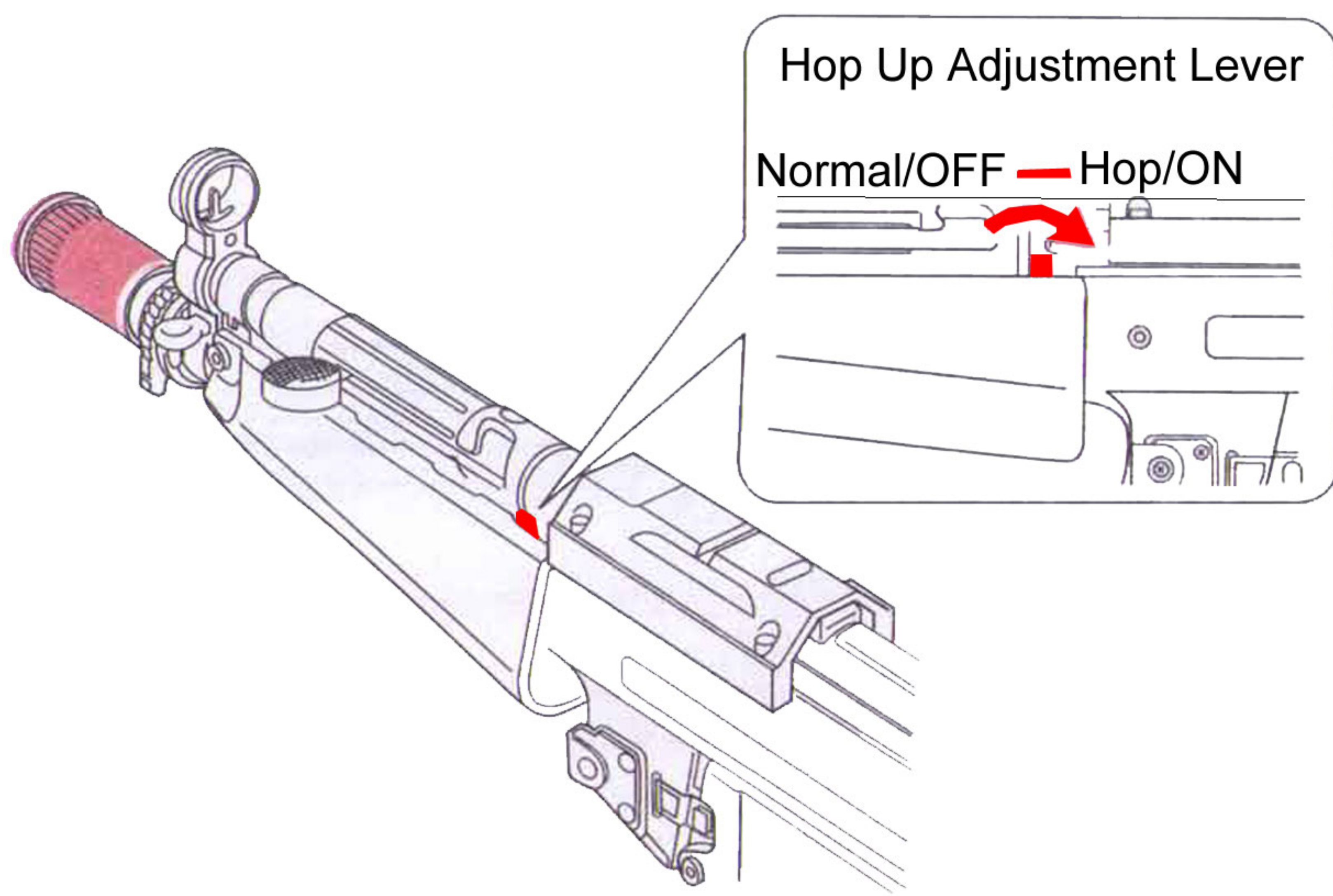

To adjust the Hop Up for the PDW or CQC model you will need to remove the RIS System or the hand guard for easy access.
The Hop Up Lever slides back and forth for adjustments.

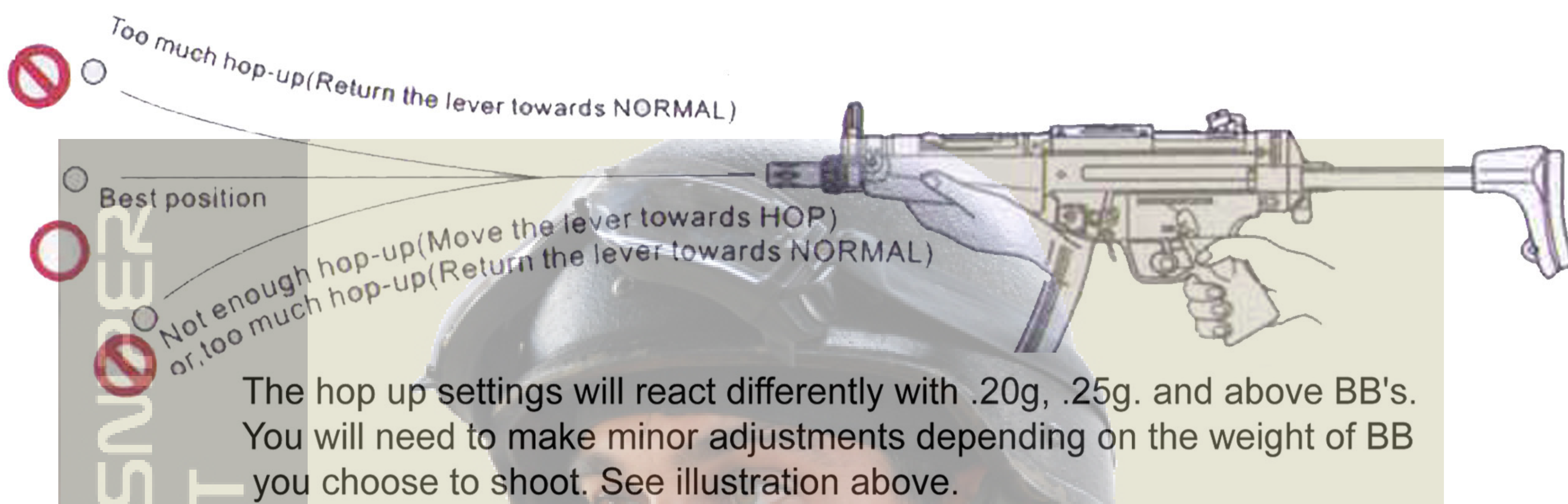

Maintenance

How to clean the barrel

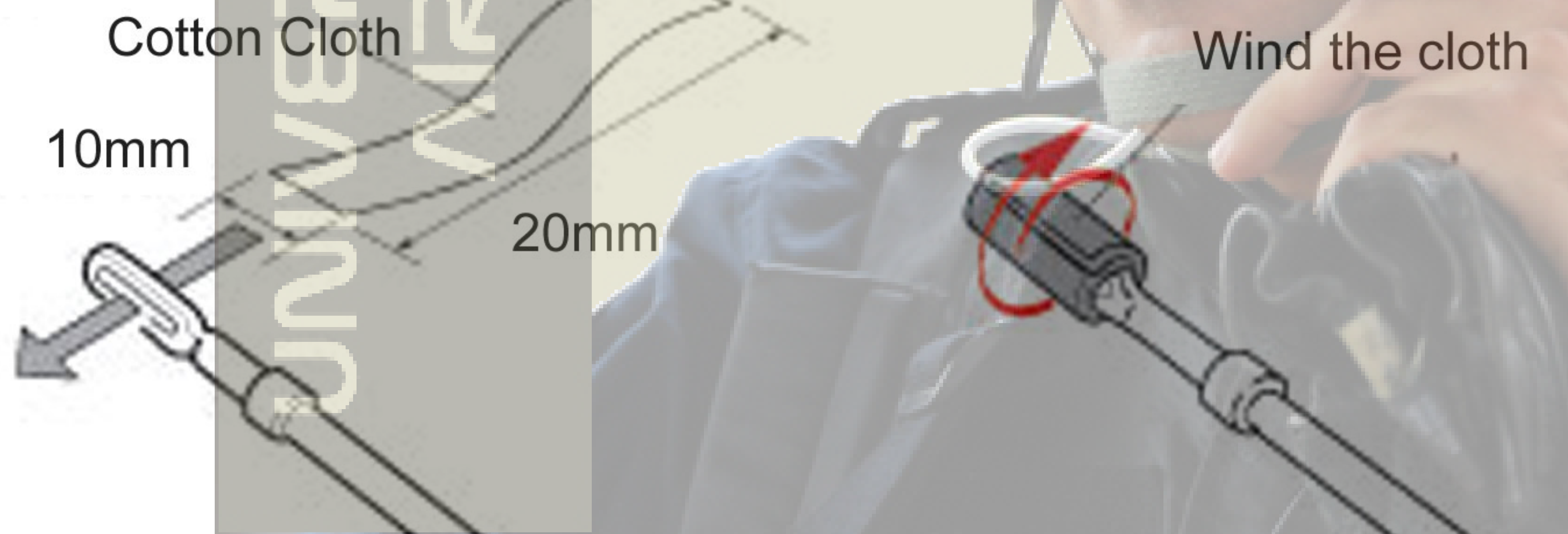

IMPORTANT:

Use only ECHO 1 BB's or BB's of equal quality consult your authorized ECHO 1 dealer for recommendations.

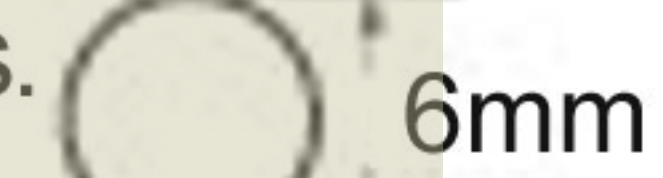

ECHO 1 6mm BB

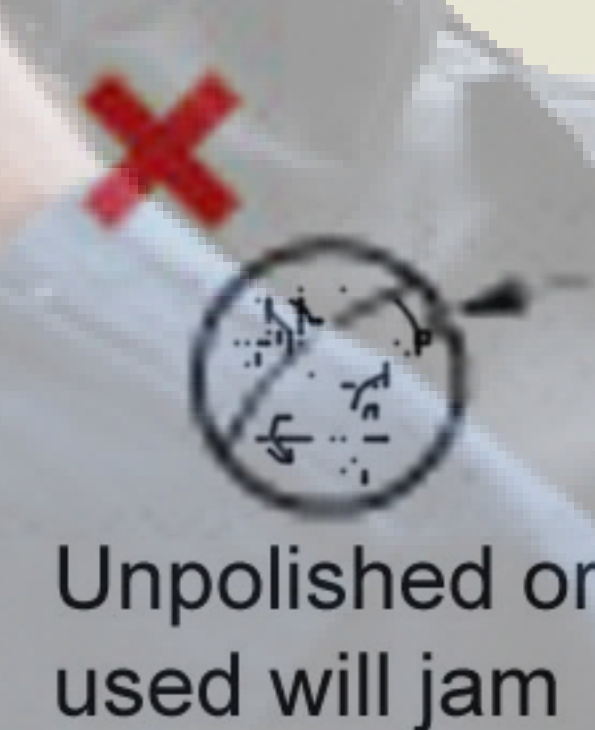

Unpolished or used will jam

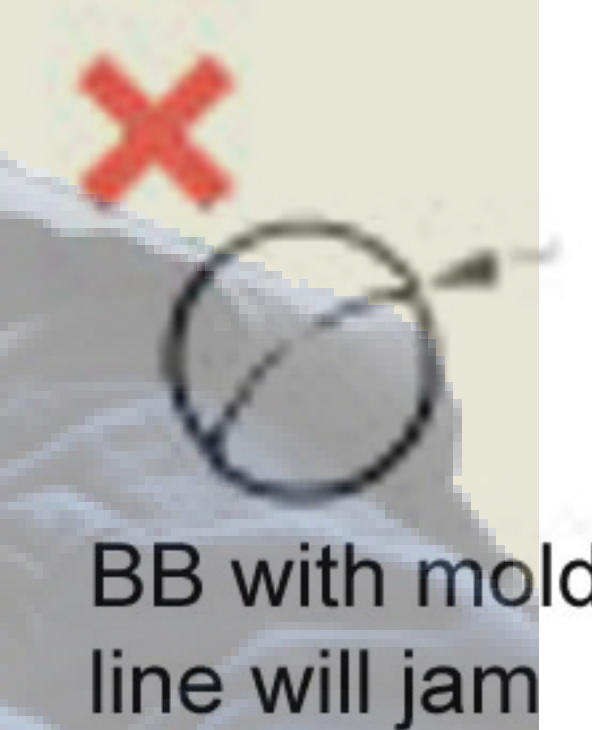

BB with mold line will jam

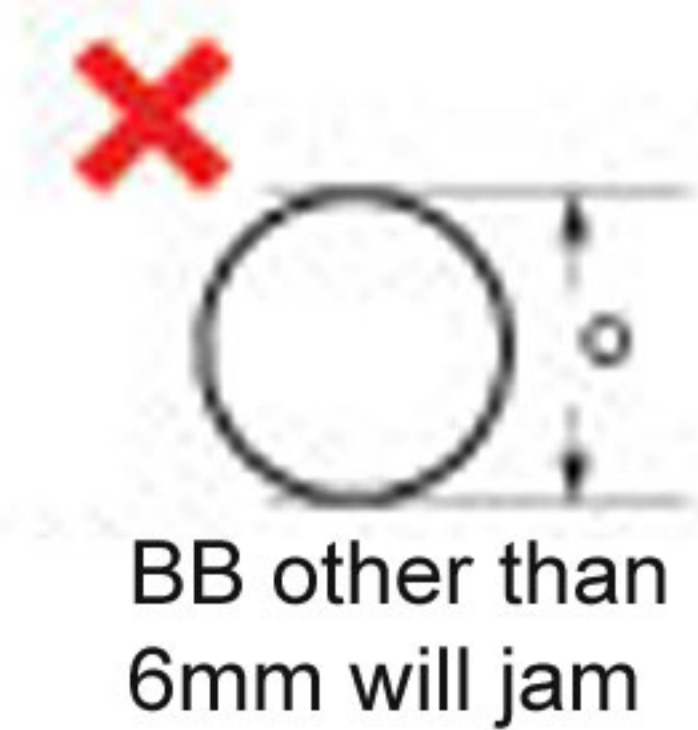

BB other than 6mm will jam

Cut the cloth in the size as shown above and insert one end into the hole in the rod. Adjust the length of the cloth to smoothly enter the barrel.

CAUTION:

Turn the hop up wheel to normal/OFF. (see Hop Up page)



CAUTION:

The barrel is a precision part and firing used BB's will cause damage.

1. Spray silicon oil into the hop up chamber from the mag well for 1 sec. and fire 20-30 BB's to oil inner barrel and hop up parts.
2. IMPORTANT: make sure the magazine and battery are removed from the gun before step 3.
3. With a twisting motion gently push the cloth and rod down the barrel. May need to use 2-3 cloth strips.

NOTE: If oil is still in barrel the BB trajectory will be unstable for 20-30 rounds.

Jammed BB

If gun is jammed with a BB follow these steps.

1. Switch gun to SAFE, remove MAGAZINE and BATTERY.
2. Turn hop up to NORMAL/OFF.
3. Use the angled end of the cleaning rod to push the BB backwards and out through the loading chamber.
4. Make sure to have the angled end as shown in figure, silicon oil will help loosen BB.
5. Continuing firing with BB jammed will cause severe damage to your AEG.

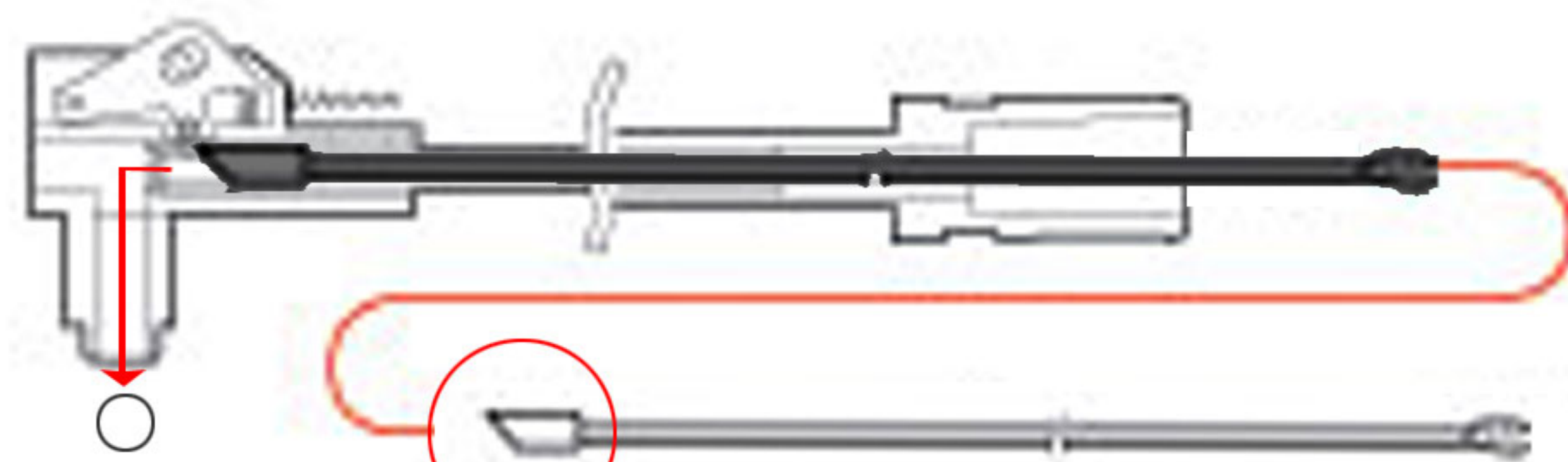

ECHO 1 User Manual

Trouble Shooting

What is the gun doing?	How to fix
Gun is making a clicking noise but not shooting.	Use a fully charged battery to unlock the gears.
The trigger is stuck and won't pull back in SEMI.	Switch the selector to FULL, fire 2-3 rounds and switch back to SEMI.
No power or noise coming from the gun.	Fuse may be blown. Replace with a 20A or 25A fuse found at most auto stores.
Grindy/Scratchy noise when shooting.	Motor height is too high/low. Turn allen screw at bottom of motor grip left or right until sound goes away.
Jamming or not shooting BB's.	Barrel is jammed, please check page 3.
Not working after troubleshoot.	Contact info@echo1usa.com on our site for more help.

