



**Elite Force 4CR**  
ELECTRIC AIR-SOFT / CAL. 6 MM

- EN Operating instructions 2 - 9
- FR Mode d'emploi 10 - 17
- ES Manual de instrucciones 18 - 25

**⚠ WARNING:** NOT A TOY. ADULT SUPERVISION IS REQUIRED. MISUSE MAY CAUSE SERIOUS INJURY, ESPECIALLY TO THE EYE. EYE PROTECTION DESIGNED FOR AIRSOFT GUNS MUST BE WORN BY THE USER AND ANY PERSON WITHIN RANGE. READ THIS OWNER'S MANUAL BEFORE USING. MAY BE DANGEROUS UP TO 220 YARDS (200 METERS).

2279055 | 03/10 © 2010

EN

**⚠ SAFE GUN HANDLING**



**DESCRIPTION**



**OPERATION**



**CARE**



**SAFETY INSTRUCTIONS**

You should be fully familiar with the proper and safe handling of your airsoft gun. The basic principles of gun safety require you to always apply the following rules when handling an airsoft gun.

- Always handle any gun as if it were loaded.
- Always put the safety of the gun "ON SAFE" when loading it so that there can be no risk of an unintentional discharge.
- Always keep your finger off the trigger and out of the trigger guard until ready to shoot.
- Only use the kind of projectiles specified for your gun.
- Always keep the muzzle pointed in a safe direction.
- Never transport a loaded gun. Only load your gun when you intend to fire it.
- Avoid ricochets. Never fire at smooth, hard surfaces or water.
- Before you discharge your gun, make sure that the target and surrounding area are safe.
- Make sure that you always have full control over the muzzle of your gun, even if you stumble or fall down.
- Safety shooting glasses should always be worn when firing any gun. Shooting glasses must be worn over normal reading glasses.
- Always store your gun in a safe place and in unloaded condition. Unauthorized persons (persons not familiar with the use of guns, children and minors) must not have access to it, ammunition is to be kept in a separate place.
- The gun together with its operating instructions may only be handed over to persons who have reached the age of 18 (or older) and who are fully familiar with the handling of it.
- Modifications or repairs of guns should only be performed by an authorized Umarex USA gunsmith.
- Never leave a loaded gun unattended.
- Only unloaded guns are to be handed over to another person.
- Make sure the gun is unloaded when getting it from storage or from another person.





**CAUTION**

You must be 18 years or older to purchase this airsoft gun. Carefully read and understand these instructions before using this airsoft gun. Buyers and users must follow the instructions for the safe use of airsoft guns.

**WARNING:** DO NOT BRANDISH OR DISPLAY THIS AIRSOFT GUN IN PUBLIC - IT MAY CONFUSE PEOPLE AND MAY BE A CRIME. POLICE AND OTHERS MAY THINK THIS AIRGUN IS A FIREARM. DO NOT CHANGE THE COLORATION AND MARKINGS TO MAKE IT LOOK MORE LIKE A FIREARM. THAT IS DANGEROUS AND MAY BE A CRIME.

**WARNING:** NEVER ASSUME THAT BECAUSE THE AIRSOFT GUN NO LONGER FIRES A BB AND/OR THE MAGAZINE IS REMOVED FROM THE GRIP FRAME THAT A PLASTIC BB IS NOT LODGED IN THE BARREL. ALWAYS TREAT THE AIRSOFT GUN AS THOUGH IT IS LOADED AND WITH THE SAME RESPECT YOU WOULD A FIREARM.

**WARNING:** NEVER LEAVE A COCKED OR LOADED AIRSOFT GUN UNATTENDED! YOU SHOULD STORE THIS GUN IN UNLOADED AND DECOCKED CONDITION. PUT THE SAFETY "ON SAFE" AND MAKE CAREFULLY SURE THAT THE BARREL IS CLEAR. KEEP THE GUN AWAY FROM CHILDREN AND PERSONS NOT SKILLED IN THE USE OF ARMS. KEEP GUN AND PROJECTILES SEPARATE FROM EACH OTHER SO THAT UNAUTHORIZED PERSONS HAVE NO ACCESS TO IT.

**TECHNICAL DATA ELITE FORCE 4CR**

System:	Electric Air-Soft
Caliber/Ammo:	cal. 6 mm BB
Energy:	> 1,0 Joule
Velocity:	350 fps (110 m/s) with 0,25 g BB
Barrel length:	11.8 in. (275 mm)
Length:	30.5 in. (775 mm)
Weight:	6.5 lbs (2952 g)
Magazine capacity:	300 BBs
Dangerous area up to.:	220 yds (200 meters)

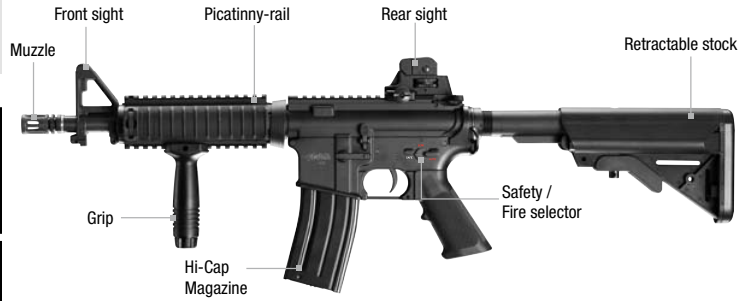

**SAFETY**

**WARNING:** YOU SHOULD MAKE IT A HABIT TO LEAVE THE SAFETY ALWAYS IN THE "ON SAFE" POSITION UNTIL YOU INTEND TO FIRE.

**CAUTION**

- Only handle the airsoft gun when it is ON SAFE.
- Always make sure that the muzzle points into a safe direction.

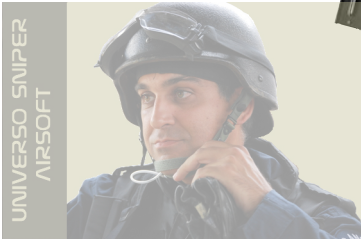

UNIVERSO SNIPER AIRSOFT

**SAFE**



**FUSE**

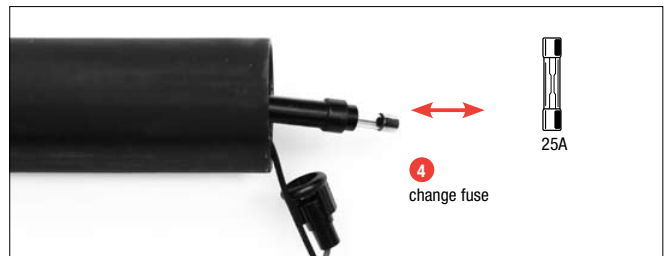
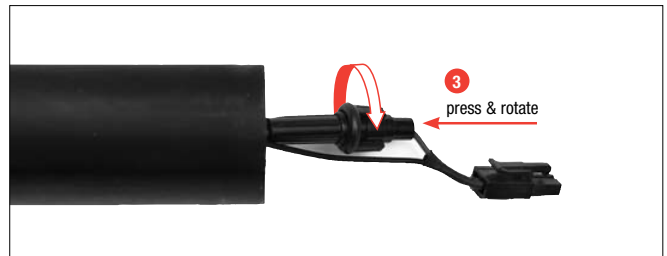



**CAUTION**

When batteries have almost lost their charge they can cause gearbox malfunctions that require repair.  
Batteries should never be over-charged. This can damage the cell.  
Prolonged overcharging causes permanent damage to batteries.  
The battery should always be drained before charging.  
There is no warranty for batteries. Use only those batteries of min. 9,6 V 3000 mAh

**WARNING:** ONLY USE ORIGINAL RECHARGEABLE BATTERIES DISTRIBUTED BY UMAREX USA COMPANY. NOTE THAT BATTERIES MUST NOT BE PUT IN THE HOUSEHOLD WASTE. DISPOSE OF THEM PROPERLY. HAND THEM IN AT YOUR LOCAL SHOP FOR DISPOSAL OR TAKE THEM TO A USED BATTERY COLLECTION LOCATION.

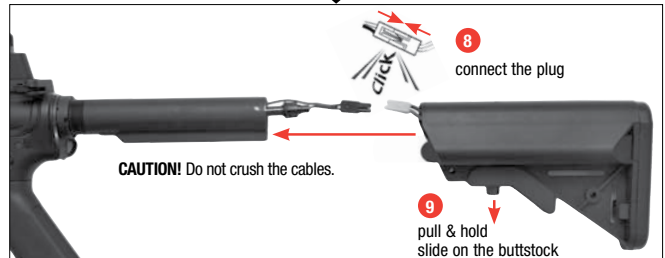
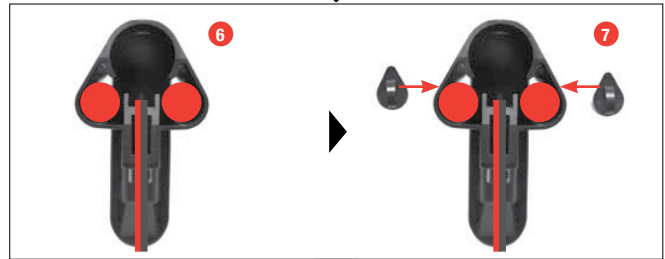
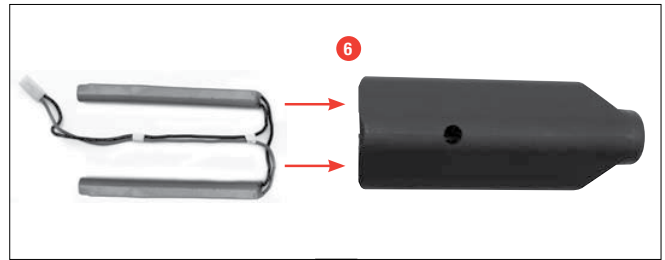
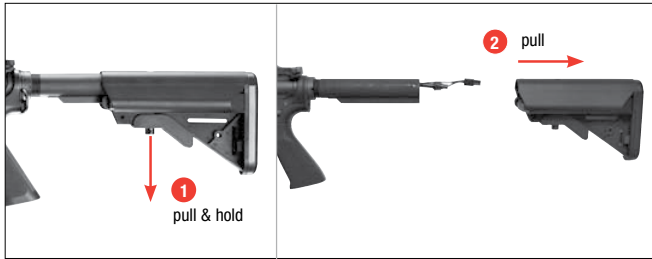

**CAUTION**

**Only use flawless high quality BBs. Never use the following BBs:**  
 1 diameter larger than 6mm, 2 with edges, 3 both halves not aligned, 4 used, soiled.  
 Warranty expires if non-recommended BBs are used.  
 It's recommended to use precision BBs from UMAREX.  
 To ensure proper operation of the magazine, protect it from dirt and dust.

**WARNING:** USE .24 CALIBER (6 MM) PLASTIC BBS ONLY IN THIS AIRSOFT GUN. USE OF ANY OTHER AMMUNITION CAN CAUSE INJURY TO YOU OR DAMAGE TO THE AIRSOFT GUN.

<b>300</b> ROUNDS	<b>WEIGHT</b> 0,2 g BB	<b>WEIGHT</b> 0,25 g BB	<b>6 mm</b> AIR SOFT
----------------------	---------------------------	----------------------------	-------------------------



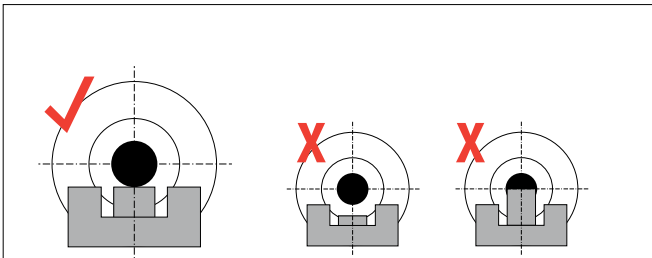
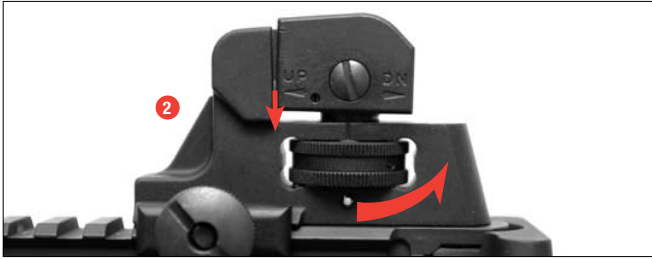
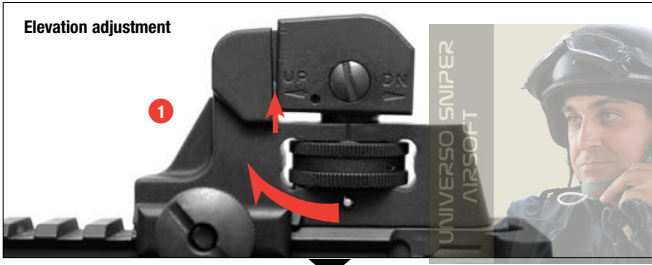

**CAUTION**

Do not pull the trigger too fast in succession. It may cause a gearjam. Do not switch the fire selector while pulling the trigger. This causes severe damage to your airsoft gun.

**WARNING:** MAKE SURE THAT THE MUZZLE OF THE GUN ALWAYS POINTS INTO A SAFE DIRECTION. NEVER AIM AT PETS OR UNSUSPECTING PERSONS. ALWAYS TREAT YOUR GUN AS IF IT WAS LOADED AND READY TO FIRE.

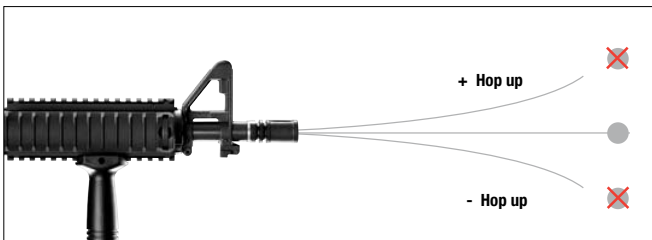
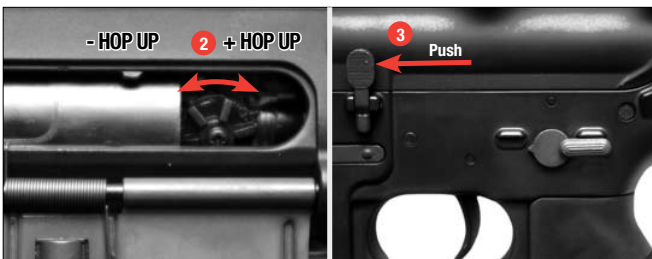
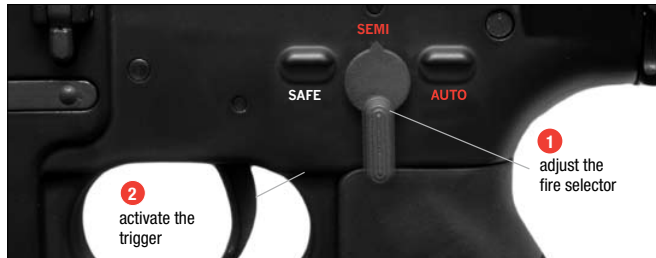
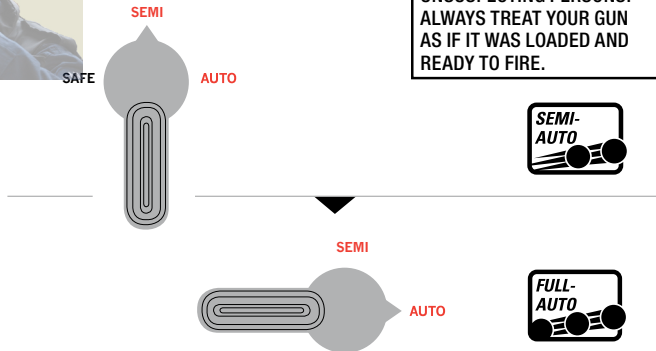

**WARNING:** NEVER ATTEMPT TO CLEAN THE GUN WITHOUT HAVING PUT THE SAFETY ON SAFE FIRST, REMOVE THE MAGAZINE AND CHECK THE BARREL, IT MUST BE CLEAR.

Perform routine inspections of the airsoft gun to check for proper operation.

**CAUTION**

- Adjust the hop up to its normal position before cleaning the airsoft gun.
- Do not force the rod into the barrel, as this could cause damage.
- Never drip silicone oil directly into the barrel.

**BARREL CLEANING**

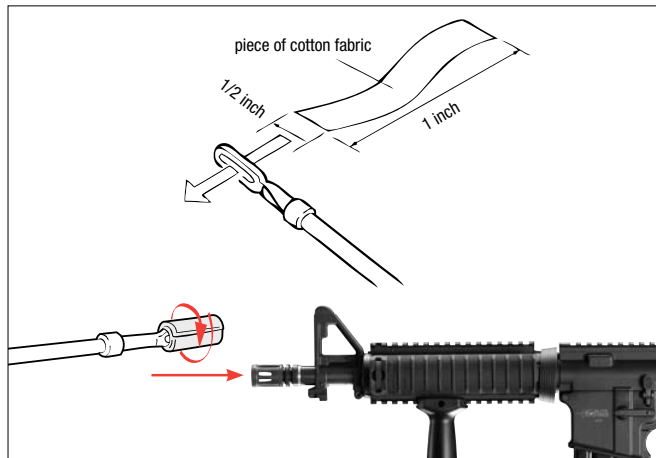

Put the safety ON SAFE and remove the magazine. Prepare a thin rod with a length of approx. 16 inches. Attach a piece of cotton fabric to its end and clean the barrel with some silicone oil.



The exposed metal parts should be wiped clean using a slightly oiled cloth after handling to prevent rust. Use light acid free and resin free oil. RWS Spring Cylinder Oil is excellent for this.

Good care and maintenance of the gun will provide you with many years of pleasant shooting.

**CAUTION**

OILS THAT CONTAIN ACID OR RESIN CAN DAMAGE SEALS AND POSSIBLY THE FINISH OF THE STOCK.

**WARRANTY**

This product is warranted to the retail consumer for one (1) year from date of purchase against defects in material and workmanship and is not transferable.

**WHAT IS COVERED** Replacement parts and labor.

**WHAT IS NOT COVERED** Shipping charges to Umarex USA for defective product and damages caused by abuse or failure to perform normal maintenance as well as any other expense.

Consequential damages, or incidental expenses, including damage to property. Some states do not allow the exclusion or limitation of incidental or consequential damages, so the above limitation or exclusion may not apply to you.

**WARRANTY CLAIMS** Warranty Claims and Repair for U.S. and Canadian customers only. Call Umarex USA (479)-646-4210 and ask for the Service Department. If it is determined a return is necessary, you will be issued a Return Authorization Number. Write this number boldly on the box and return the product prepaid to Umarex USA. Your name, address, phone number and a note explaining the defect found must be included in the package. A copy of the original purchase receipt must accompany the return. Include a check made to Umarex USA in the amount of \$21.95 to cover shipping and handling.

**IMPLIED WARRANTIES** Any implied warranties, including the implied warranties of merchantability and fitness for a particular purpose, are limited in duration to one (1) year from date of retail purchase. Some states do not allow limitations on how long an implied warranty lasts, so the above limitations may not apply to you. To the extent any provision of this warranty is prohibited by federal, state, or municipal law which cannot be preempted, it shall not be applicable. This warranty gives you specific legal rights, and you may also have other rights which vary from state to state and country to country.

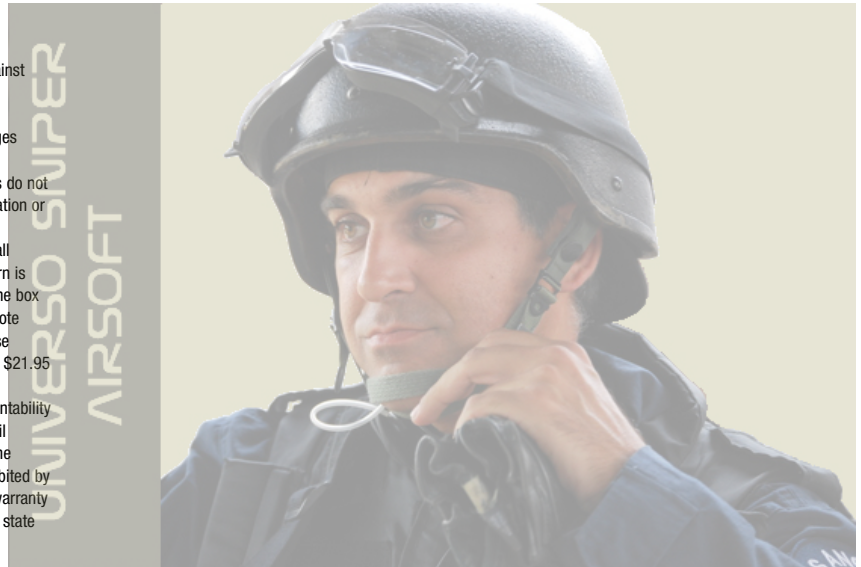

<b>FULL METAL GEAR</b>	<b>SHOTS/Min 1200</b>	<b>ELECTRIC</b>	<b>VELOCITY 350 fps</b>
<b>FULL-AUTO</b>	<b>SEMI-AUTO</b>	<b>METAL BARREL</b>	<b>Hi CAP 300</b>
<b>HOP-UP ADJUSTABLE</b>	<b>REAR SIGHT ADJUSTABLE</b>	<b>6mm AIRSOFT</b>	
<b>★★★★ AUTHENTIC REPLICA</b>	<b>LENGTH 30.5 in.</b>	<b>WEIGHT 6.5 lbs</b>	
<b>METAL GUN</b>	<b>ENERGY &gt; 1 JOULE</b>	<b>METAL PARTS</b>	

Distributed by / Distribué par:  
**UMAREXUSA®**  
www.UmarexUSA.com

7700 Chad Colley Boulevard  
Fort Smith, AR 72916  
Phone: 479-646-4210

We reserve the right to make color and design changes and technical improvements. No responsibility is accepted for printing errors or incorrect information.

Sauf modifications de la couleur et du design ainsi que des améliorations techniques, erreurs d'impression et erreur. Toutes les données sont fournies sans garantie.

Salvo modificaciones de color y de diseño así como mejoramientos técnicos, erratas y error. Todos los datos sin garantía.