

# RK SERIES MANUAL



[WWW.GUAY2.COM](http://WWW.GUAY2.COM)

**G&G ARMAMENT**  
AIRSOFT GUNS & ACCESSORIES

G2-201608-01 英

## TAIWAN

**ChangHua (Head Quarter)** | Tel : +886-4-798-9000 Fax : +886-4-798-9900  
No.999, Zhonghua Rd. Shengang Township,  
Changhua County 50952, Taiwan (R.O.C.)

**Taipei** | Tel : +886-2-2692-2000 Fax : +886-2-2692-4000  
11F-3., No.27, Lane 169, Kangning St. Shijr City,  
Taipei County 22180, Taiwan (R.O.C.)

**Sales Dept.** | sales@guay2.com, b2b@guay2.com  
**Technology Dept.** | support@guay2.com  
**PR Dept.** | pr@guay2.com

## U.S.A.

**Los Angeles** | Tel : +1-626-581-0101  
Fax : +1-626-581-1011  
1122 Coiner Court City of Industry,  
CA91748 (U.S.A.)  
sales101@guay2.com

UNIVERSO SIMPER  
AIRSOFT

# RK SERIES MANUAL



UNIVERSO SIMPER  
AIRSOFT

## TOP FIVE



- FUTURE INNOVATION
- BEST QUALITY
- FAST SERVICE
- FREE ITEMS
- AIR PRICE



- ▲ All products employ a high precision 6.04mm barrel. Using 5.95mm BB pellets is highly recommended. Damage to the product due to faulty BB pellets voids the warranty. Use with caution.
- ▲ The buyer and the user of this product shall adhere to all local laws regulating the usage and the ownership of airsoft guns.

- ▲ This product is intended for users 18 years or older.
- ▲ Read all instructions before using this product.
- ▲ Adult supervision required.
- ▲ Always wear safety goggles when using this product.
- ▲ Misuse or careless handling of this product may cause injury.
- ▲ May be hazardous up to 50 meters.

- Orange tip disclaimer :**
- ▲ All G&G Airsoft guns come with a permanent fixed orange tip required by law, which will grant Airsoft legal usage in the United States.
  - ▲ If you alter, modify, abuse, or remove the orange tip, all warranty coverage will be void.

**Warning**  
 For more product information please visit our website [www.guay2.com](http://www.guay2.com)



You may be liable for damaging public, personal property, or for injuring a person or an animal. Always observe good manners and enjoy fun sport shooting.



Safety procedures:  
 1. Attach the safety cap to the muzzle.  
 2. Set the selector lever to the safety position.  
 3. Remove the magazine.



When shooting the air guns for target practice or in a game situation, you and all participants must wear safety goggles or other eye protective gear. Please pay attention to ricochets and third parties around you.



When you carry the air gun, attach the safety cap, set the selector lever to the safety position, and always put the air gun in a case or bag.



Select a safe place for operating the air gun and avoid places where people and cars are around.



Always attach the safety cap to the muzzle, remove the battery and store the air gun in a case or bag and at a place that is out of reach of children.

Never direct the muzzle towards a person, animal, or in any direction that may cause harm or damage to a third party.

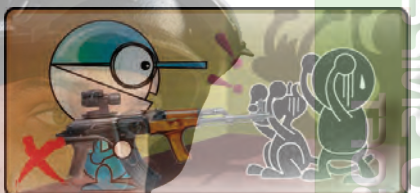

Looking into the muzzle is extremely dangerous, regardless of having BB's loaded or not. If you get hit in the eye by a BB pellet, worst case scenario, you may lose your eye sight.



There may be cases where some BB's remain in the gun after the magazine has been removed. After removal of the magazine, direct the muzzle towards a safe direction and pull the trigger to confirm that there are no BB's remaining in the gun, then attach the safety cap.



Make sure to put the barrel and safety cap onto the muzzle except when shooting, to prevent any accidents, discharge of BB's, and also for dust protection purposes. Never pull the trigger while the barrel and safety cap are attached.



Activating the trigger carelessly is extremely dangerous. Never put your finger on the trigger unless the safety cap is removed and you are ready to shoot a target.



Disassembling or modifying the gun may adversely affect the performance and make it dangerous. It would also void all warranty.





★ GIMS  
 ( P7 · 15~16 · 20~26 · 41~42 )  
 HANDGUARD BATTERY

★ GKMS  
 ( P9 · 15 · 19 · 21~26 · 43~44 )

★ GKMS CARBINE  
 ( P9 · 15 · 19 · 21~26 · 45~46 )

★ GK74 CARBINE  
 ( P10 · 15 · 19 · 21~26 · 45~46 )

★ GKS74U  
 ( P11 · 15 · 19 · 20~26 · 39~40 )

★ RK47 WOOD  
 ( P5 · 15 · 17 · 21~23 · 25~28 )



★ GK74  
 ( P8 · 15~16 · 20~26 · 39~40 )  
 HANDGUARD BATTERY

★ GKS74  
 ( P15 · 21~23 · 25~26 · 47~50 )  
 HANDGUARD BATTERY

★ GKSG74  
 ( P15 · 21~23 · 25~26 · 47~50 )

★ GK74N  
 ( P8 · 15~16 · 21~26 · 39~40 )  
 HANDGUARD BATTERY

★ GKM  
 ( P7 · 15~16 · 21~26 · 41~42 )  
 HANDGUARD BATTERY



★ RK104  
 ( P6 · 15 · 17 · 21~23 · 25~26 · 29~30 )

★ RK103  
 ( P6 · 15 · 17 · 21~23 · 25~26 · 29~30 )

★ GK74M  
 ( P15 · 21~23 · 25~26 · 47~50 )  
 HANDGUARD BATTERY

★ GK74M  
 ( P15 · 21~23 · 25~26 · 47~50 )

★ RK BETA  
 ( P11 · 15 · 17 · 21~23 · 25~26 · 35~36 )



★ RK104 EVO  
 ( P6 · 15 · 17 · 21~23 · 25~26 · 31~32 )

★ RK104 EVO CRANE  
 ( P6 · 15~16 · 21~23 · 25~26 · 33~34 )

★ RK103 EVO  
 ( P6 · 15 · 17 · 21~23 · 25~26 · 31~32 )

★ RK103 EVO CRANE  
 ( P6 · 15~16 · 21~23 · 25~26 · 33~34 )

★ GK99  
 ( P12 · 15 · 18 · 20~23 · 25~26 · 37~38 )



**RK47 WOOD**

For more product information  
please visit our website  
[www.guay2.com](http://www.guay2.com)

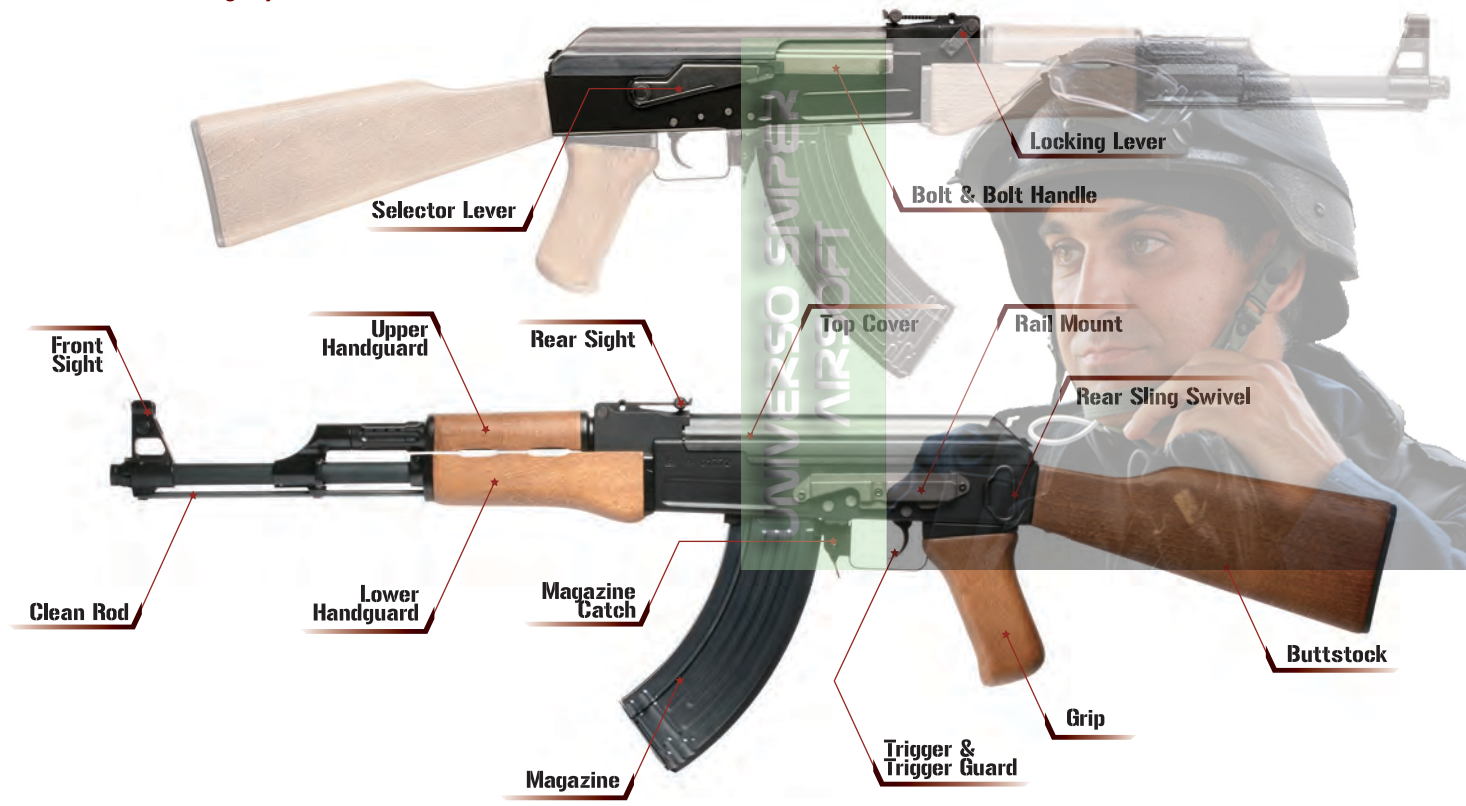

**RK103 / RK104 / RK103 EVO / RK104 EVO  
RK103 EVO CRANE / RK104 EVO CRANE**





**GKM / GIMS**

For more product information  
please visit our website  
[www.guay2.com](http://www.guay2.com)

**GK74 / GK74N**

For more product information  
please visit our website  
[www.guay2.com](http://www.guay2.com)

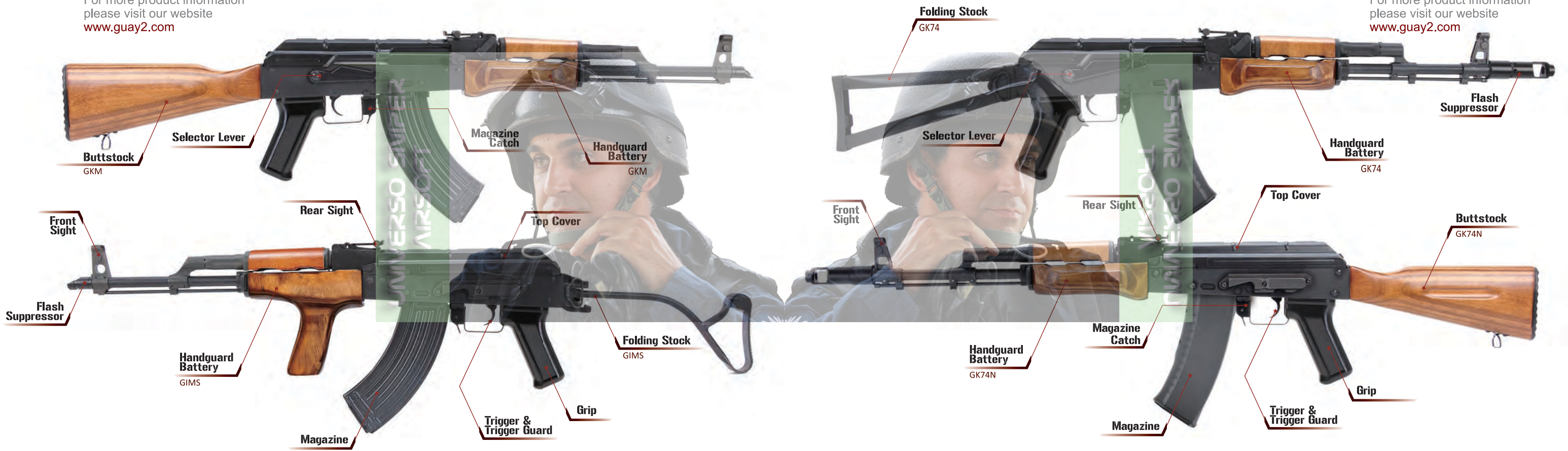



**■ GKMS CARBINE / GKMS**

For more product information  
please visit our website  
[www.guay2.com](http://www.guay2.com)

**■ GK74 CARBINE**

For more product information  
please visit our website  
[www.guay2.com](http://www.guay2.com)



**Selector Lever**

**Handguard**  
GKMS Carbine

**Selector Lever**

**Bolt & Bolt Handle**

**Front Sight**

**Rear Sight**

**Top Cover**

**Front Sight**

**Rear Sight**

**Top Cover**

**Flash Suppressor**

**Handguard Battery**  
GKMS

**Folding Stock**  
GKMS / GKMS Carbine

**Handguard**  
GK74 Carbine

**Folding Stock**  
GK74 Carbine

**Magazine**

**Trigger & Trigger Guard**

**Grip**

**Magazine**

**Trigger & Trigger Guard**

**Grip**



RK BETA / GKS74U

For more product information  
 please visit our website  
[www.guay2.com](http://www.guay2.com)

GK99

For more product information  
 please visit our website  
[www.guay2.com](http://www.guay2.com)





In order to simulate the bolt action of a real firearm, G&G is proud to present its new Pneumatic Blow Back system to its line of airsoft guns.

Conventional airsoft blow back utilizes tow hook springs that connect to the piston head and bolt plate to simulate bolt action, which often lead to excess wear and tear and poor reliability in the gear box. To alleviate the problem of conventional systems, G&G has independently developed the Pneumatic Blow Back system for a better solution on simulating bolt actions.

This new technology utilizes compressed air to move the bolt, which enables the action without adding extra stress to the gear box.

This class leading system represents a significant milestone in the airsoft industry.

UNIVERSO MILITARE AIRSOFT

UNIVERSO MILITARE

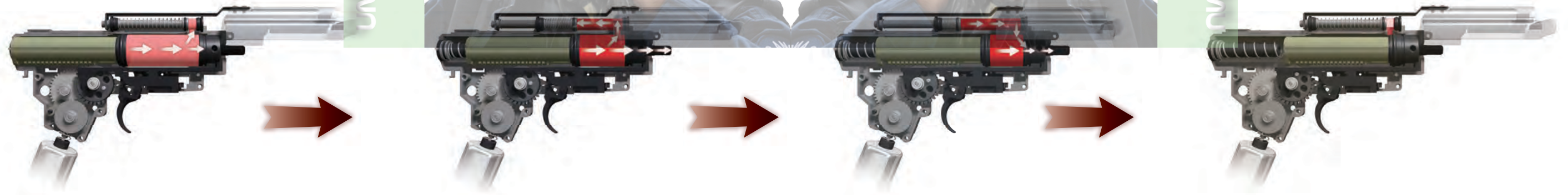

**TAIWAN**  
 Patent No. M300797



**USA**  
 Patent No. 11/488698



**HONG KONG**  
 Patent No. 06107627.0



**JAPAN**  
 Patent No. 實願2006-1459



**EUROPEAN UNION**  
 Patent No. 460191 814454



**CHINA**  
 Patent No. 200620122468.9



**DENMARK**  
 Patent No. BA2007 0069



**U.K.**  
 Patent No. 614422.4





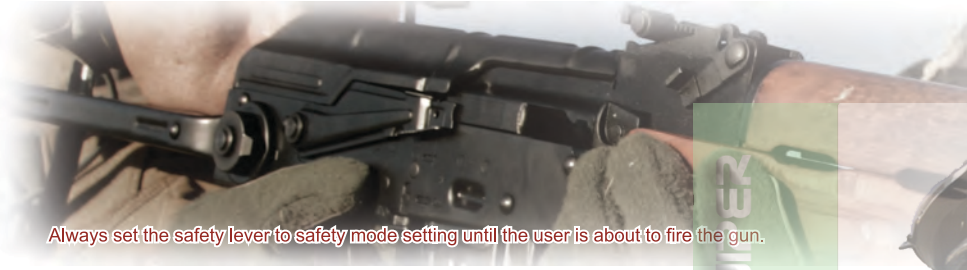

Always set the safety lever to safety mode setting until the user is about to fire the gun.

**CAUTION**

- ▶ Never operate the selector switch while pulling the trigger. Otherwise, malfunctions may occur.
- ▶ Pulling the trigger with the Selector being set at safe mode may damage the air gun.

**SAFETY ON**  
 THE TRIGGER CANNOT BE PULLED



When the gun is in storage or not being fired, always set the selector to the Safe position and attach the protective cap on the muzzle.

**FULL AUTO**  
 AUTOMATIC FIRING



The gun will fire continuously while the trigger remains pulled.

**SEMI AUTO**  
 SINGLE SHOT



The gun will fire one shot each time when the trigger is pulled.

**CAUTION**  
 Direct the muzzle towards a safe direction and set the selector to the safety position. The magazine should be removed before changing the battery.

**For GKM / GIMS / GK74 / GK74N**



1 Push the button and pull forward to unlock the handguard battery.

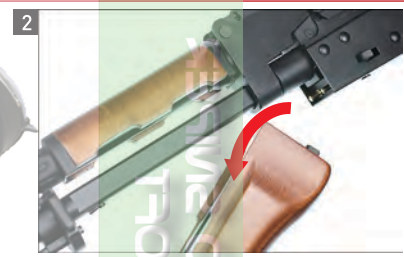

2 Remove the handguard battery.

**For RK103 EVO CRANE / RK104 EVO CRANE**



1. Pull and hold the stock release lever mount.  
 2. Pull out the stock.

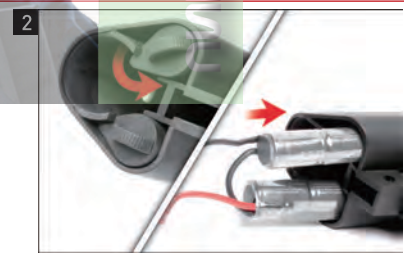

1. Turn and take off the battery cover.  
 2. Insert the battery into the stock.



**LED Indication**

[ Power ] Blue Light (ON)  
 [ Error Status ] Red Light (Flashing) / [ Normal ] Red Light (OFF)  
 [ Fully Charged ] Green Light (ON) / [ Normal ] Green Light (OFF)  
 When the green light flashing more frequently shows the charging speed is faster. When the battery is nearly full, the green light will be on consistently.

**CAUTION**  
 Make sure the longitudinal slits always present on pin connector. If the pin connector has been deformed, it may disable the firing function!



You can use the razor blade to expand the slit and spread the two halves of the pin to compensate for wear.



1. Connect the battery plug into the connector until you hear a 'click'.  
 2. Reinstall the stock.





**CAUTION** Direct the muzzle towards a safe direction and set the selector to the safety position. The magazine should be removed before changing the battery.

For RK47 / RK103 / RK104 / RK103 EVO / RK104 EVO

-   
Unscrew the fixing screws and remove the plate.
-   
Connect the battery until you hear a 'click'.
-   
Insert the battery and reinstall the plate.

For RK Beta

-   
Push the stock plate and remove.
-   
Connect the battery plug with the connector until you hear a 'click'.
-   
Reinstall the stock plate.

**CAUTION** Direct the muzzle towards a safe direction and set the selector to the safety position. The magazine should be removed before changing the battery.

For GK99

-   
Unscrew the handguard cap.
-   
Pull the handguard forward.
-   
Remove the handguard and pull out the connector.

For GK99

-   
Connect the battery until it click into place.
-   
Put the handguard back on.
-   
Tighten up the handguard cap.



**CAUTION** Direct the muzzle towards a safe direction and set the selector to the safety position. The magazine should be removed before changing the battery.

**For GKST4U / GK74 Carbine / GKMS Carbine**



Push the cover release button and remove the dust cover.



Connect the battery until it clicks into place.



Put back the dust cover.

**For GKMS / GKMS Carbine**



Push the stock lock button to unlock.

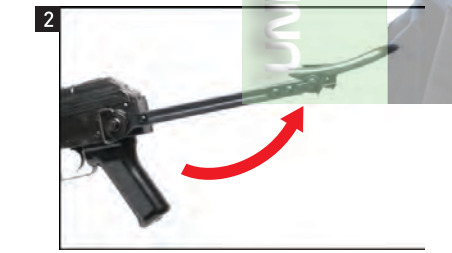

Unfold the underfolding stock and make sure it is securely locked in place.



Fold down the end of stock for better shouldering.

**For GIMS**



Push the stock lock lever to unlock the folding stock.



Unfold the stock and make sure it is securely locked in place.

**For GK74 / GKST4U**

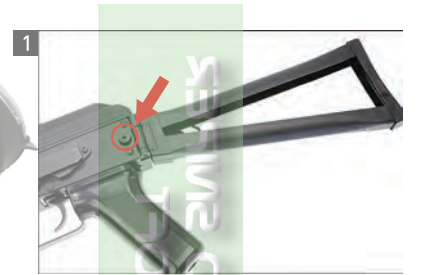

Push the stock lock button to unlock.



Fold the stock to the side and make sure it is securely locked in place.

**For GK99**

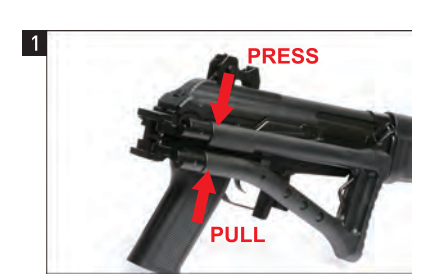

Squeeze both arms of the stock to unlock.



Unfold the stock and make sure it is securely locked in place.



**CAUTION** Confirm that the safety lever is set to the Safety position and do not place your finger on the trigger.

*For All RK Series*

**CAUTION**  
 Always use the G&G BB pellet or diameter 5.94 ~ 5.96 mm BBs for this air gun. G&G shall not be held responsible for any damage or accidents arising from the use of pellets supplied by other manufacturers.



1 Push the magazine catch to release the magazine.



2 Open the cover of the magazine and load G&G 5.95mm BB pellets into the magazine.

*For All RK Series*



3 Turn the winding wheel on the bottom of the magazine to tighten the spring. This will allow the BBs to feed through the top of the magazine.



4 Insert the magazine as shown in the picture 4.



5 Make sure the magazine is securely inserted into the receiver until it clicks.

**Front Sight Adjustment**

*For All RK Series*



1 Insert the front sight adjustment tool into the front sight block.



2 Clockwise : Lower the front sight.  
 Counterclockwise : Raise the front sight.

**Front Sight Adjustment** *For GK99*



1 Use the screwdriver to adjust the front sight windage.



2 Flip-Up night front sight.

**CAUTION** Ensure not to lose the adjustment tool.

**Rear Sight Adjustment**

*For All RK Series ( Apart from RK Beta / GK99 )*



1 Press the button and slide forward or backward for adjustment.

**Rear Sight Adjustment** *For GK99*



1 Full Auto shooting.



2 Precision shooting.



**CAUTION** Do not to catch your fingers in the dummy bolt.

**\* NOTE** Adjust only when the gear noise becomes shrill.

*For All RK Series*



1 Pull the handle in the direction shown to open the bolt.

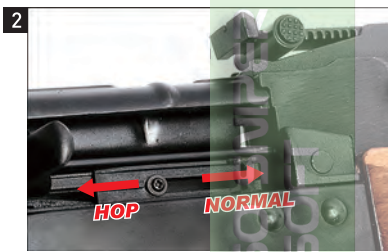

2 Slide the hop-up adjustment piece forward or backward to adjust the Hop-up effect.

*For All RK Series*



1 Unscrew the fixing screw on the bottom of the grip and remove the grip.

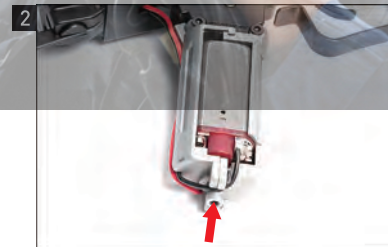

2 Adjust with hexagon key.

*For GKS74U / GK74 Carbine / GKMS Carbine*

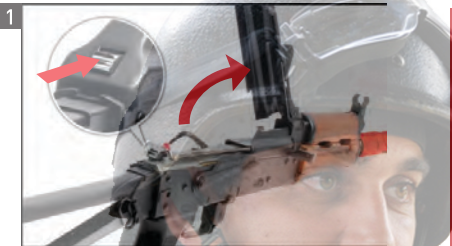

1 Push the cover release button.  
 2 Remove or lift up the dust cover.

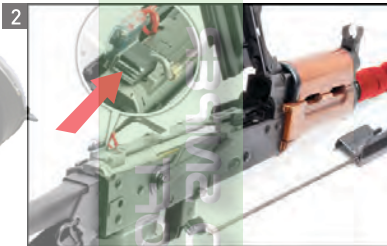

2 Push the rear-end of the spring guide to remove the bolt set.

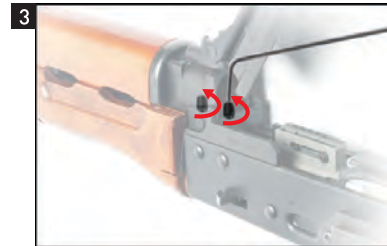

3 Use 2mm hexagon key to unscrew the barrel bracket set screws.

*For GKM / GKMS / GIMS / GK74 / GK74N*



1 Push the button and pull forward to remove the handguard battery.



2 Unscrew the screw and the front kit can now be disassembled.

**CAUTION** Never hold the gun sideways as the BB pellets will curve right or left.

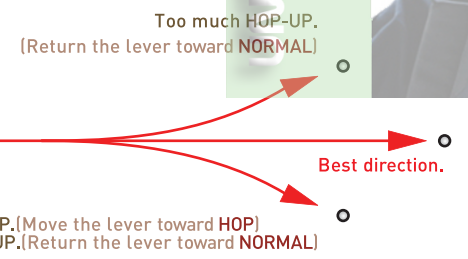



**1. After Operation**

Remove the magazine, direct the muzzle into a safe direction, then fire the gun in semi-auto mode for a few shots. Set the selector to the safe position. Always disconnect the battery and attach the protective cap whenever you are not operating the air gun.

**2. Cautions on Motor and Battery**

Charge the battery if the firing cycle becomes slow. Stop the usage of the air gun for 5 to 10 minutes after firing around 500 rounds in order to ensure the long life of the motor and battery.

**3. Clogged Pellets**

If pellets are clogged, remove and apply a few drops of G&G's silicone oil into the chamber from the magazine entrance. Apply the silicone for 0.4 to 1 sec to obtain smooth continuous firing.

**WHEN PELLET SPEED BECOMES LOW**

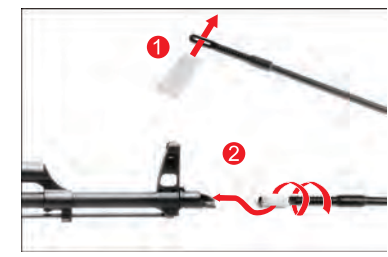

1. Place a few drops of silicone oil or teflon oil into the pellet entrance. After inserting BB pellets into the magazine, fire the gun around 200-300 rounds.
2. To complete the cleaning, use the cleaning rod (with cotton) to remove excess oil.

**CAUTION**

Make sure no dirt gets into the chamber to avoid clogging of pellets. The hop up operation may be unstable for the first 200 to 300 rounds after using silicone oil, this is the normal operation of the gun.



**REMOVING CLOGGED PELLETS**

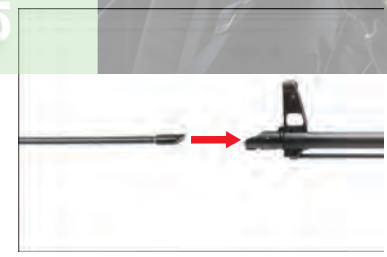

1. Return the hop-up dial to the Normal position and insert the cleaning rod from the lead edge of the barrel.
2. To remove clogged BB's, carefully insert the cleaning rod inside with the flat tip facing down as shown below.

**CAUTION**

Do not jam the cleaning rod into the barrel by force. Should the BB's remain inside the barrel after following the instruction above, point the gun to a safe direction and discharge any loosened BB's in semi-automatic mode.

**Troubleshooting**

SYMPTOM	POTENTIAL	CORRECTIVE
No operation at all	Selector lever is set to safety.	Set the selector lever to Semi or Full Auto.
	Battery is not charged.	Charge the battery.
	Battery connector is disconnected.	Connect the connector.
	The + and - of battery connector is reversed.	Switch the batteries to the correct position.
Although motor is revolving, no pellet can be fired	Expired motor life (50,000 to 60,000 rounds) or poor electrical connection.	Replace the dead motor (can be purchased from local dealer or directly from G&G). Check and repair the contacts.
	Pellets are clogged inside the magazine.	Insert the charging rod into the magazine and move up and down a few times to remove clogged pellets.
	Pellets are clogged in the chamber.	Remove clogged pellets using the cleaning rod.
Impossible full-auto operation (automatic firing)	Faulty gear.	Purchase the replacement gear from your dealer or G&G and repair.
	Insufficient battery power.	Charge the battery.
	Faulty pellet feed of magazine.	Repair clogging of the magazine.
Shooting distance becomes shorter	Poor electrical connection.	Consult your dealer or G&G for overhaul maintenance or repair.
	Damaged or worn chamber set.	Replace the replacement parts (purchase from your dealer or G&G)
	Damaged or worn piston set (O-ring, piston spring)	
	Something is jammed in the inner barrel.	Use the cleaning rod and clean the inner barrel.
	Faulty BB pellets (too small or heavy)	Use the genuine G&G Pellets.
Loud operating noise	Shortage of silicone oil	Place a few drops of silicone oil onto the upper chamber.
	Gear problem caused by too many blank firing	Consult your dealer or G&G for overhaul maintenance, part replacement (gear, etc.) or repair.
	Worn or damaged gear	
Pellets being fallen out from barrel end	Gear problem caused by too many blank firing	Turn the hop adjustment lever toward Hop.
	Damaged or worn chamber set.	
If gun gets wet	No hop setting.	Use the G&G Pellets.
	Faulty BB Pellets (too small or heavy)	
	Stop operation immediately, disconnect the battery, wipe off water from inside the main body and the battery. After the gun is completely dry, carry out trial firing. If the unit is not operational, please contact your local dealer for repair.	

**Disclaimer**

- Accessories pictured are not always included with product.
- Adult supervision required for users under 18 years of age.
- The purchaser and user should conform to all laws governing the ownership of airsoft guns.
- All products in this manual are imitation firearms and are not intended nor represented to be comparable in design, appearance, or function to any actual firearm offered by other manufacturers.
- Product names are trademarks of G&G, which has no affiliation to, and is not associated, or sponsored by any manufacturer of actual or imitation firearms. Products may vary from those pictured.

for RK47

for RK47

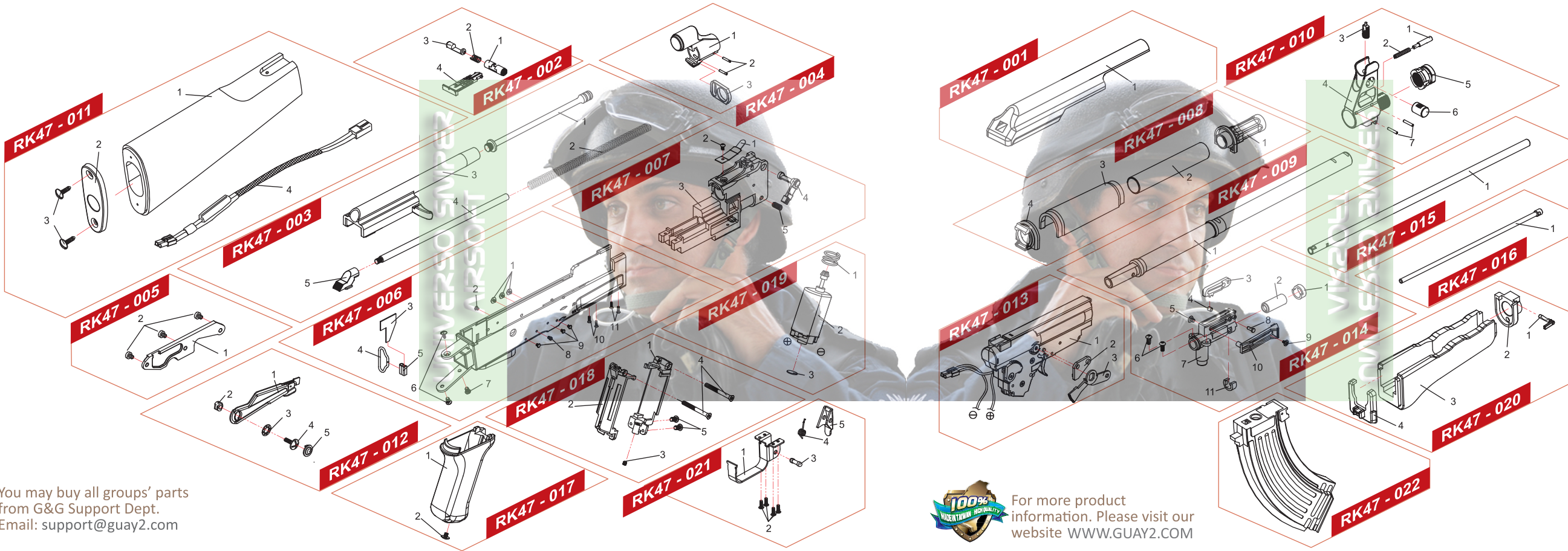

You may buy all groups' parts from G&G Support Dept.  
Email: support@guay2.com



For more product information. Please visit our website [WWW.GUAY2.COM](http://WWW.GUAY2.COM)

- RK47-001** Receiver Cover Set
- RK47-002** Rear Sight Set
- RK47-003** Bolt Set
- RK47-004** Gas Block Set
- RK47-005** Rail Mount Set
- RK47-006** Receiver Set
- RK47-007** Barrel Base Set
- RK47-008** Gas Cylinder Set
- RK47-009** Outer Barrel Set
- RK47-010** Front Sight Set
- RK47-011** Butt Stock Set
- RK47-012** Selector Lever Set
- RK47-013** Gear Box Set
- RK47-014** Hop Up Set
- RK47-015** Inner Barrel
- RK47-016** Clean Rod
- RK47-017** Grip Set
- RK47-018** Motor Base Set
- RK47-019** Motor Set
- RK47-020** Handguard Set
- RK47-021** Trigger Guard Set
- RK47-022** Magazine

You may buy all groups' parts from G&G Support Dept.  
Email: support@guay2.com



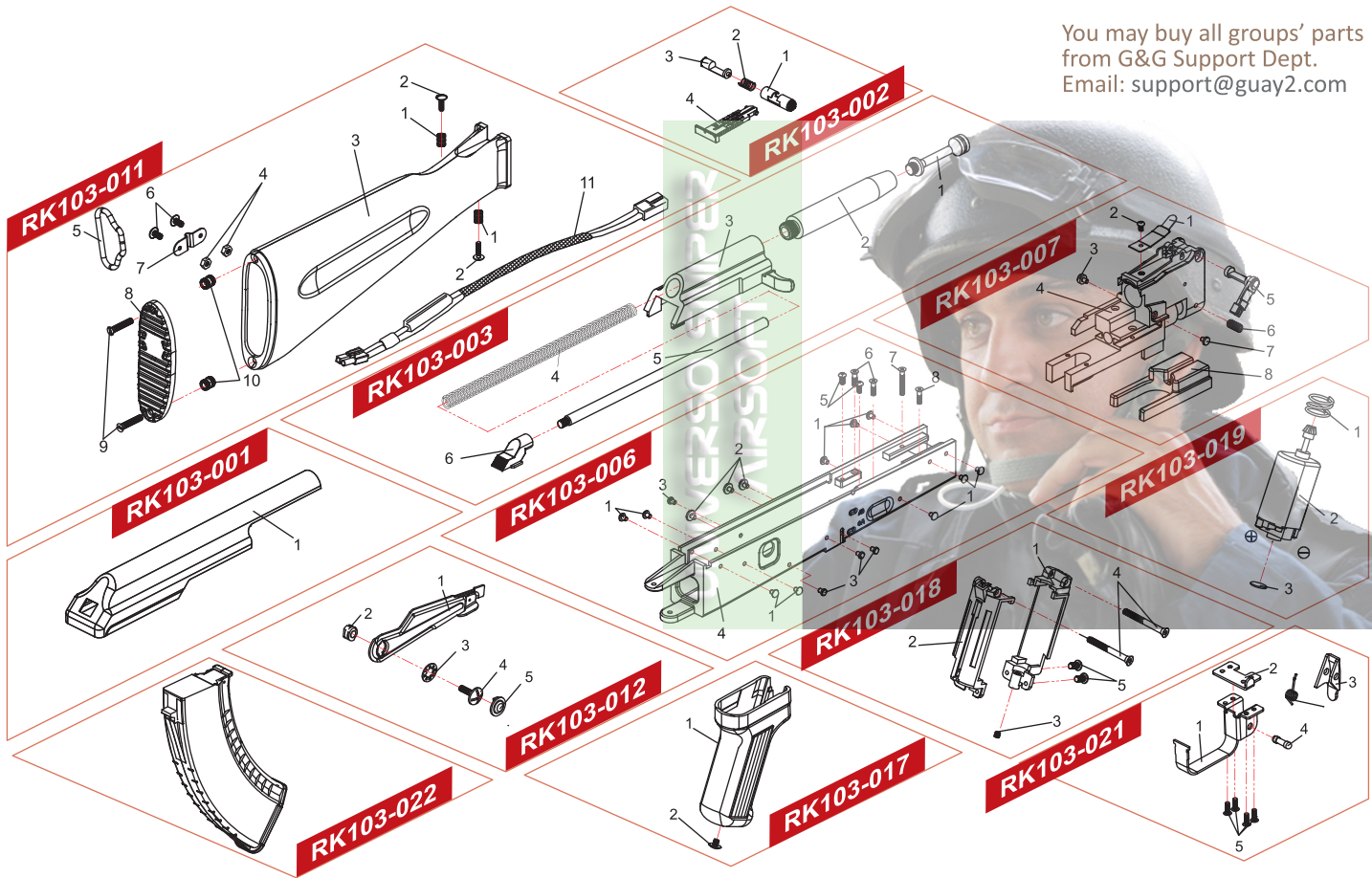

You may buy all groups' parts from G&G Support Dept.  
Email: support@guay2.com

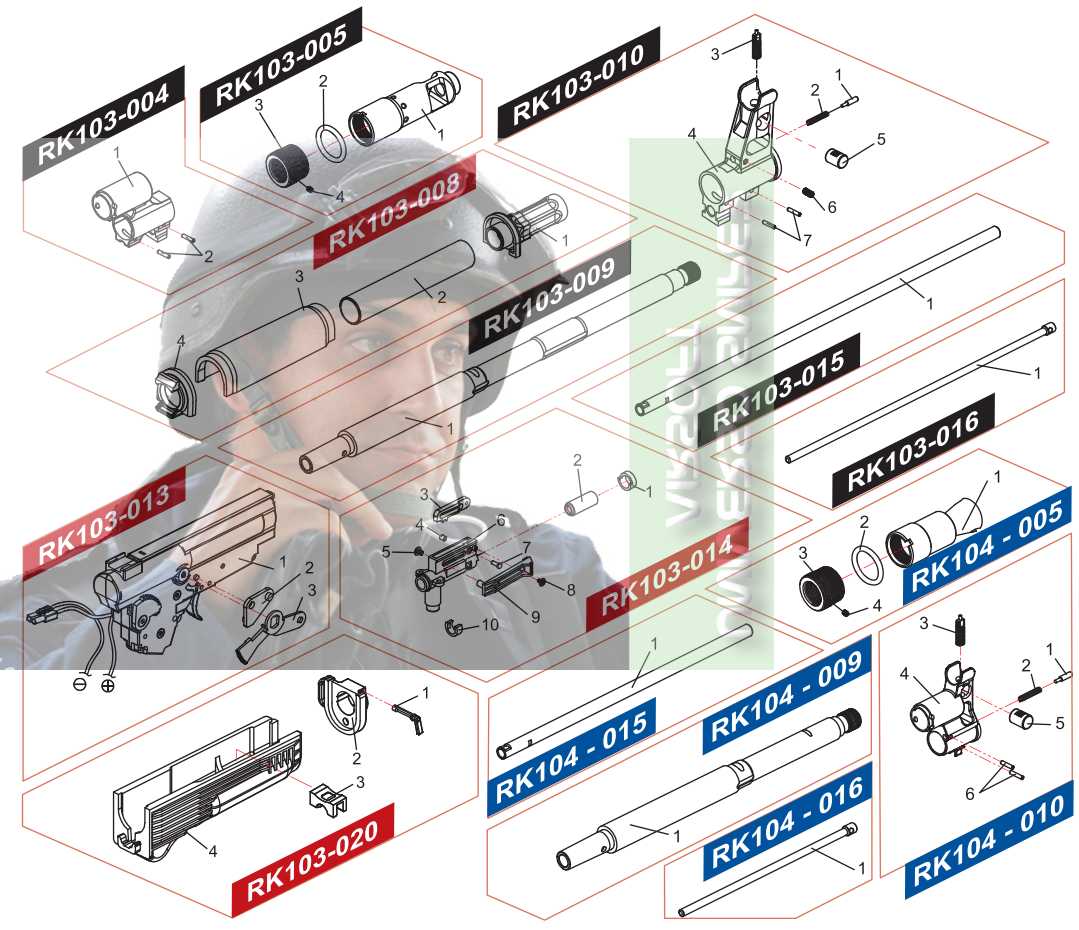

- for RK103 / RK104
- RK103-001** Receiver Cover Set
  - RK103-002** Rear Sight Set
  - RK103-003** Bolt Set
  - RK103-006** Receiver Set
  - RK103-007** Barrel Base Set
  - RK103-008** Gas Cylinder Set
  - RK103-011** Butt Stock Set
  - RK103-012** Selector Lever Set
  - RK103-013** Gear Box Set
  - RK103-014** Hop Up Set
  - RK103-017** Grip Set
  - RK103-018** Motor Base Set
  - RK103-019** Motor Set
  - RK103-020** Handguard Set
  - RK103-021** Trigger Guard Set
  - RK103-022** Magazine

- for RK103
- RK103-004** Gas Block Set
  - RK103-005** Flash Suppressor Set
  - RK103-009** Outer Barrel Set
  - RK103-010** Front Sight Set
  - RK103-015** Inner Barrel
  - RK103-016** Clean Rod

- for RK104
- RK104-005** Flash Suppressor Set
  - RK104-009** Outer Barrel Set
  - RK104-010** Front Sight Set
  - RK104-015** Inner Barrel
  - RK104-016** Clean Rod

You may buy all groups' parts from G&G Support Dept.  
Email: support@guay2.com

for RK103 EVO / RK104 EVO

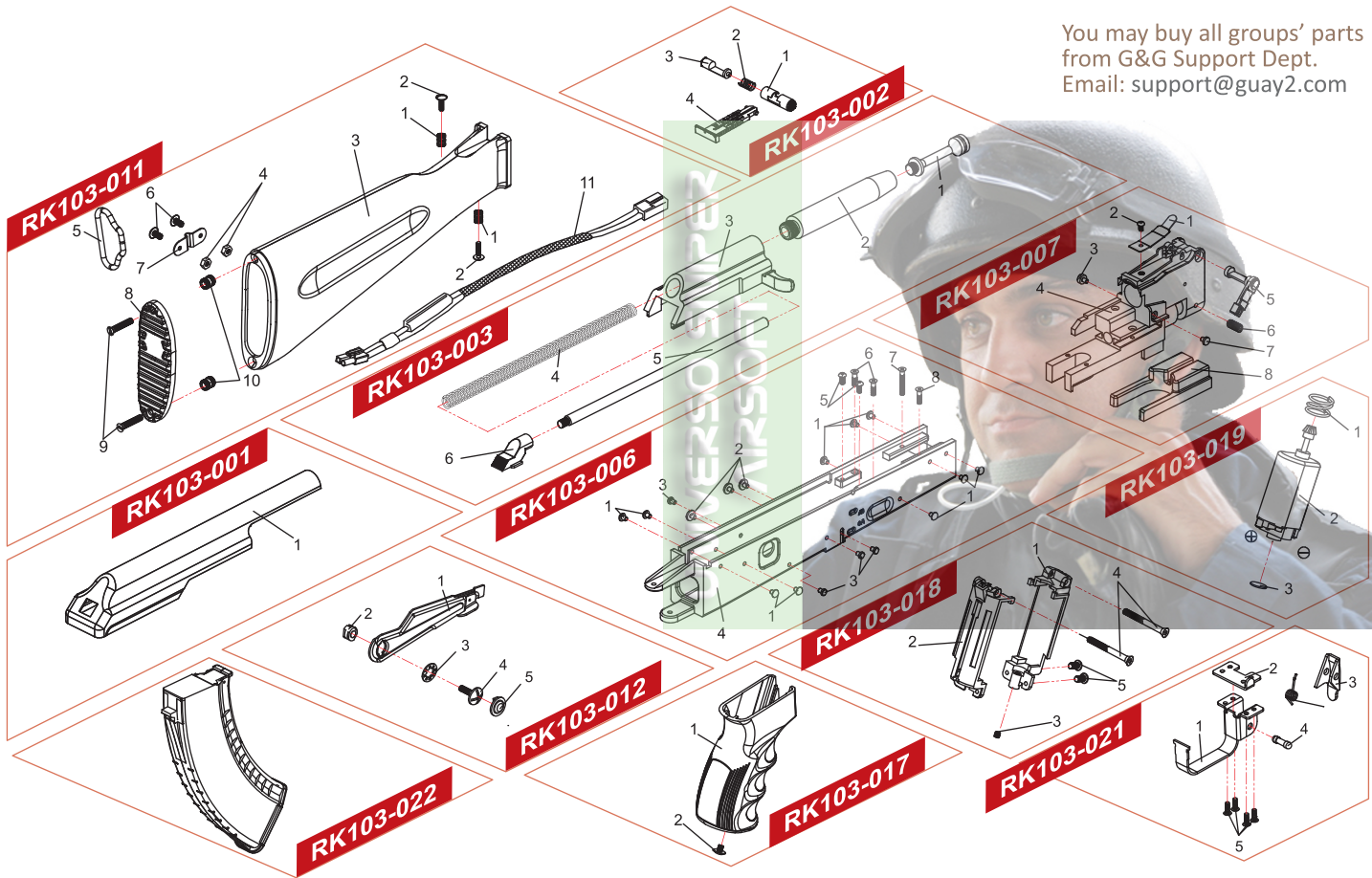

You may buy all groups' parts from G&G Support Dept.  
Email: support@guay2.com

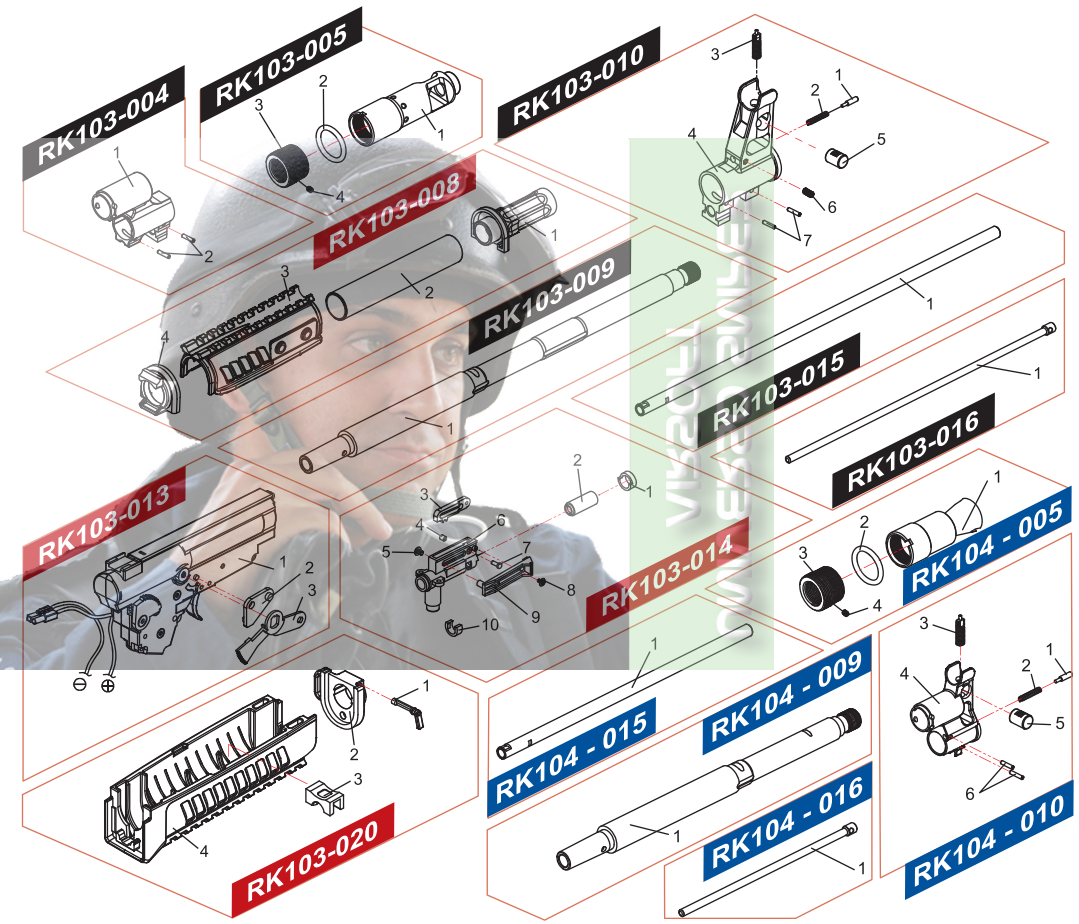

for RK103 EVO / RK104 EVO

- RK103E-001** Receiver Cover Set
- RK103E-002** Rear Sight Set
- RK103E-003** Bolt Set
- RK103E-006** Receiver Set
- RK103E-007** Barrel Base Set
- RK103E-008** Gas Cylinder Set
- RK103E-011** Butt Stock Set
- RK103E-012** Selector Lever Set
- RK103E-013** Gear Box Set
- RK103E-014** Hop Up Set
- RK103E-017** Grip Set
- RK103E-018** Motor Base Set
- RK103E-019** Motor Set
- RK103E-020** Handguard Set
- RK103E-021** Trigger Guard Set
- RK103E-022** Magazine

for RK103 EVO

- RK103E-004** Gas Block Set
- RK103E-005** Flash Suppressor Set
- RK103E-009** Outer Barrel Set
- RK103E-010** Front Sight Set
- RK103E-015** Inner Barrel
- RK103E-016** Clean Rod

for RK104 EVO

- RK104E-005** Flash Suppressor Set
- RK104E-009** Outer Barrel Set
- RK104E-010** Front Sight Set
- RK104E-015** Inner Barrel
- RK104E-016** Clean Rod

You may buy all groups' parts from G&G Support Dept.  
Email: support@guay2.com



for RK103 EVO CRANE / RK104 EVO CRANE

You may buy all groups' parts from G&G Support Dept.  
 Email: support@guay2.com

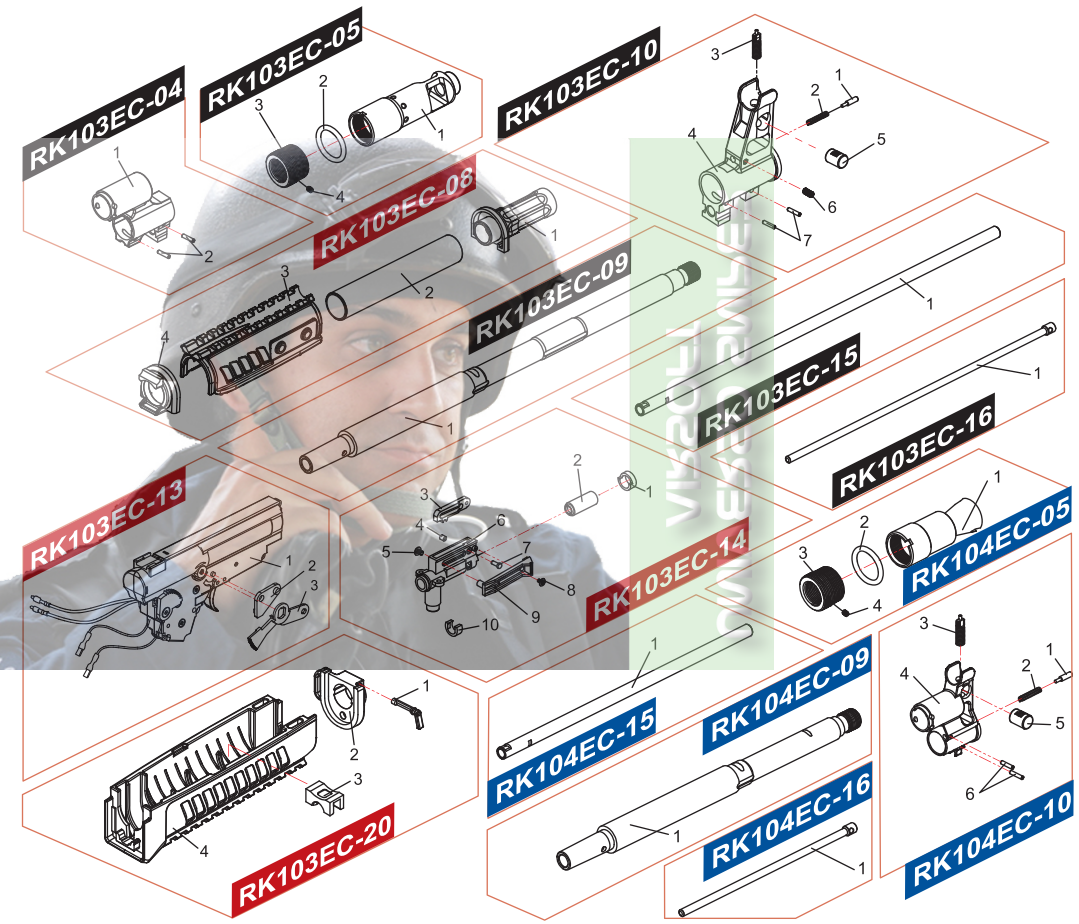
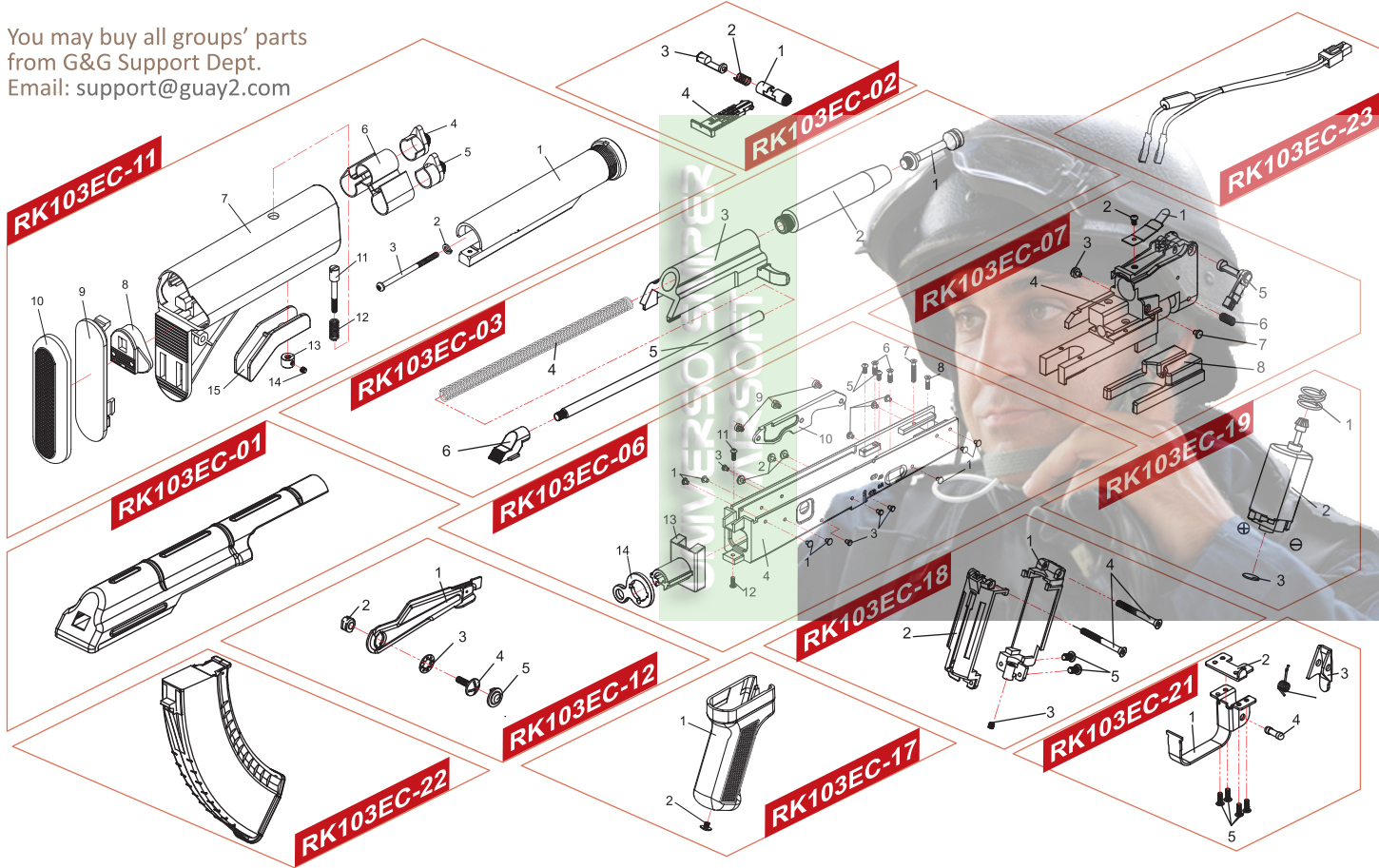

for RK103 EVO CRANE / RK104 EVO CRANE

- RK103EC-01** Receiver Cover Set
- RK103EC-02** Rear Sight Set
- RK103EC-03** Bolt Set
- RK103EC-06** Receiver Set
- RK103EC-07** Barrel Base Set
- RK103EC-08** Gas Cylinder Set
- RK103EC-11** Butt Stock Set
- RK103EC-12** Selector Lever Set
- RK103EC-13** Gear Box Set
- RK103EC-14** Hop Up Set
- RK103EC-17** Grip Set
- RK103EC-18** Motor Base Set
- RK103EC-19** Motor Set
- RK103EC-20** Handguard Set
- RK103EC-21** Trigger Guard Set
- RK103EC-22** Magazine
- RK103EC-23** Cord Set

for RK103 EVO CRANE

- RK103EC-04** Gas Block Set
- RK103EC-05** Flash Suppressor Set
- RK103EC-09** Outer Barrel Set
- RK103EC-10** Front Sight Set
- RK103EC-15** Inner Barrel
- RK103EC-16** Clean Rod

for RK104 EVO CRANE

- RK104EC-05** Flash Suppressor Set
- RK104EC-09** Outer Barrel Set
- RK104EC-10** Front Sight Set
- RK104EC-15** Inner Barrel
- RK104EC-16** Clean Rod

for RK BETA

for RK BETA

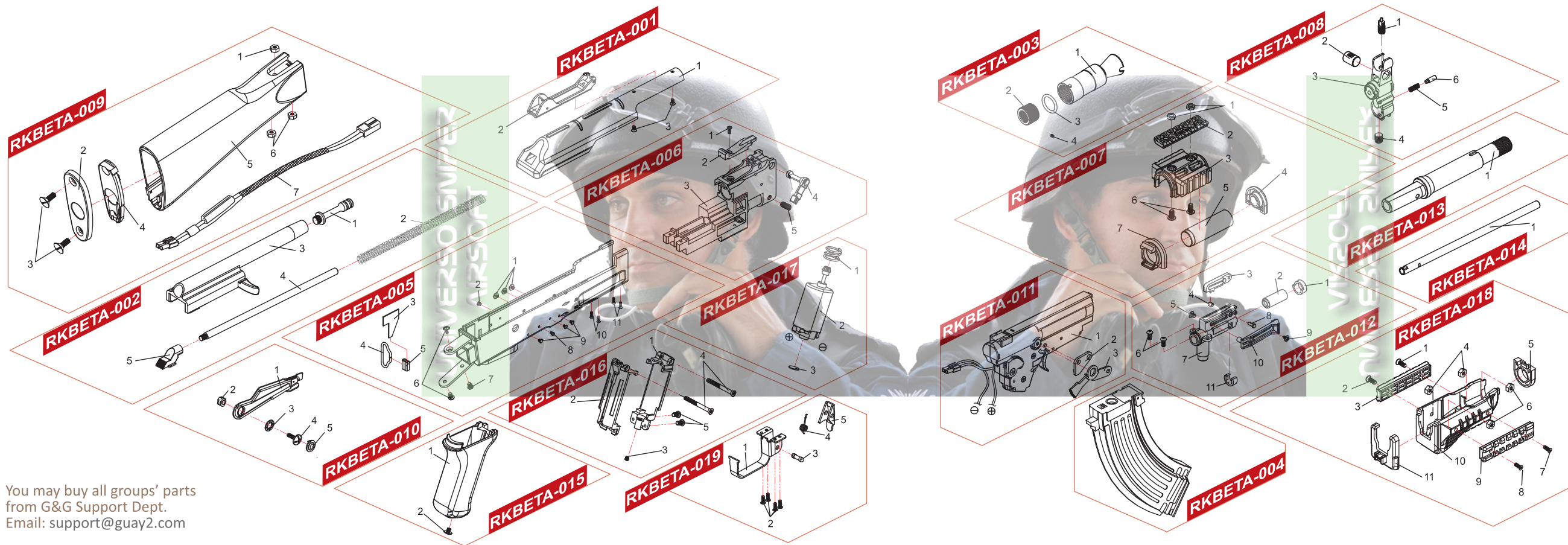

- RKBETA-001** Receiver Cover Set
- RKBETA-002** Bolt Set
- RKBETA-003** Flash Suppressor
- RKBETA-004** Magazine
- RKBETA-005** Receiver Set
- RKBETA-006** Barrel Base Set
- RKBETA-007** Gas Cylinder Set
- RKBETA-008** Front Sight Set
- RKBETA-009** Butt Stock Set
- RKBETA-010** Selector Lever Set
- RKBETA-011** Gear Box Set
- RKBETA-012** Hop Up Set
- RKBETA-013** Outer Barrel
- RKBETA-014** Inner Barrel
- RKBETA-015** Grip Set
- RKBETA-016** Motor Base Set
- RKBETA-017** Motor Set
- RKBETA-018** Rail Handguard Set
- RKBETA-019** Trigger Guard Set

You may buy all groups' parts from G&G Support Dept.  
Email: support@guay2.com

You may buy all groups' parts from G&G Support Dept.  
Email: support@guay2.com



for GK99 BlowBack Ver.

for GK99 BlowBack Ver.

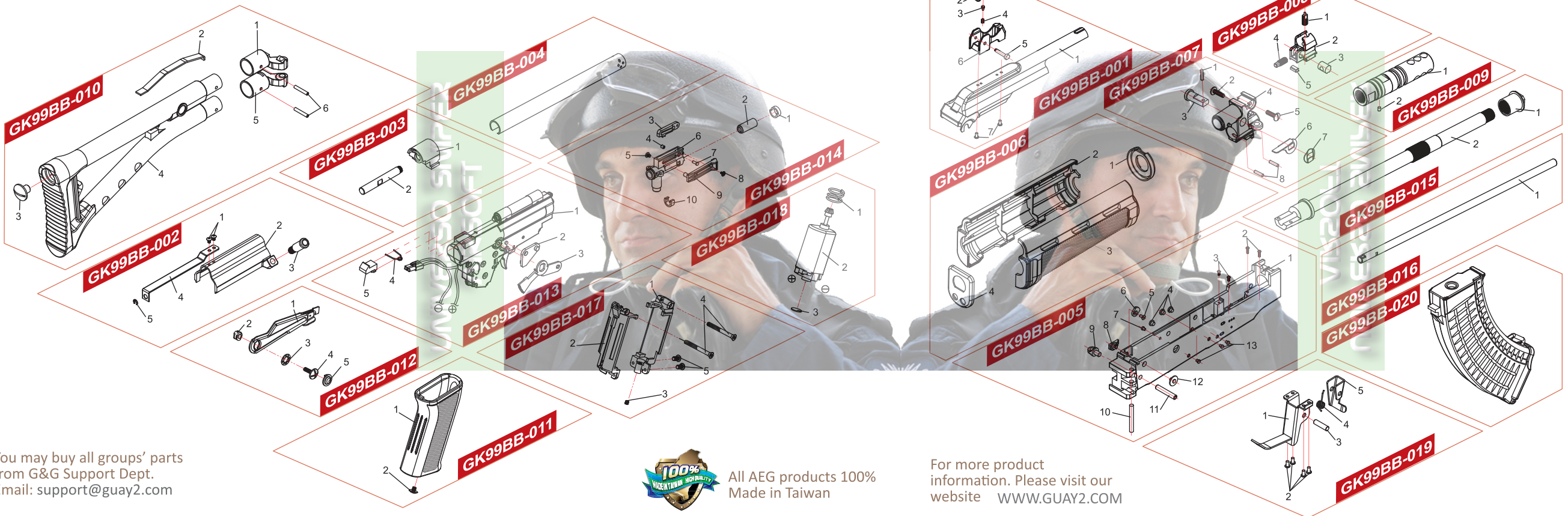

You may buy all groups' parts from G&G Support Dept.  
 Email: support@guay2.com

**100% MADE IN TAIWAN HIGH QUALITY**  
 All AEG products 100% Made in Taiwan

For more product information. Please visit our website [WWW.GUAY2.COM](http://WWW.GUAY2.COM)

- GK99BB-001 Receiver Cover Set
- GK99BB-002 Bolt Lever Set
- GK99BB-003 Bolt Guide Set
- GK99BB-004 Gas Tube
- GK99BB-005 Receiver Set
- GK99BB-006 Handguard Set
- GK99BB-007 Gas Block Set
- GK99BB-008 Front Sight Set
- GK99BB-009 Flash Suppressor
- GK99BB-010 Folding Stock Set
- GK99BB-011 Grip
- GK99BB-012 Selector Lever Set
- GK99BB-013 Gear Box Set
- GK99BB-014 Hop Up Set
- GK99BB-015 Outer Barrel Set
- GK99BB-016 Inner Barrel
- GK99BB-017 Motor Base Set
- GK99BB-018 Motor Set
- GK99BB-019 Trigger Guard Set
- GK99BB-020 Magazine

You may buy all groups' parts from G&G Support Dept.  
 Email: support@guay2.com

for GK74 / GK74N / GKS74U

You may buy all groups' parts from G&G Support Dept.  
Email: support@guay2.com

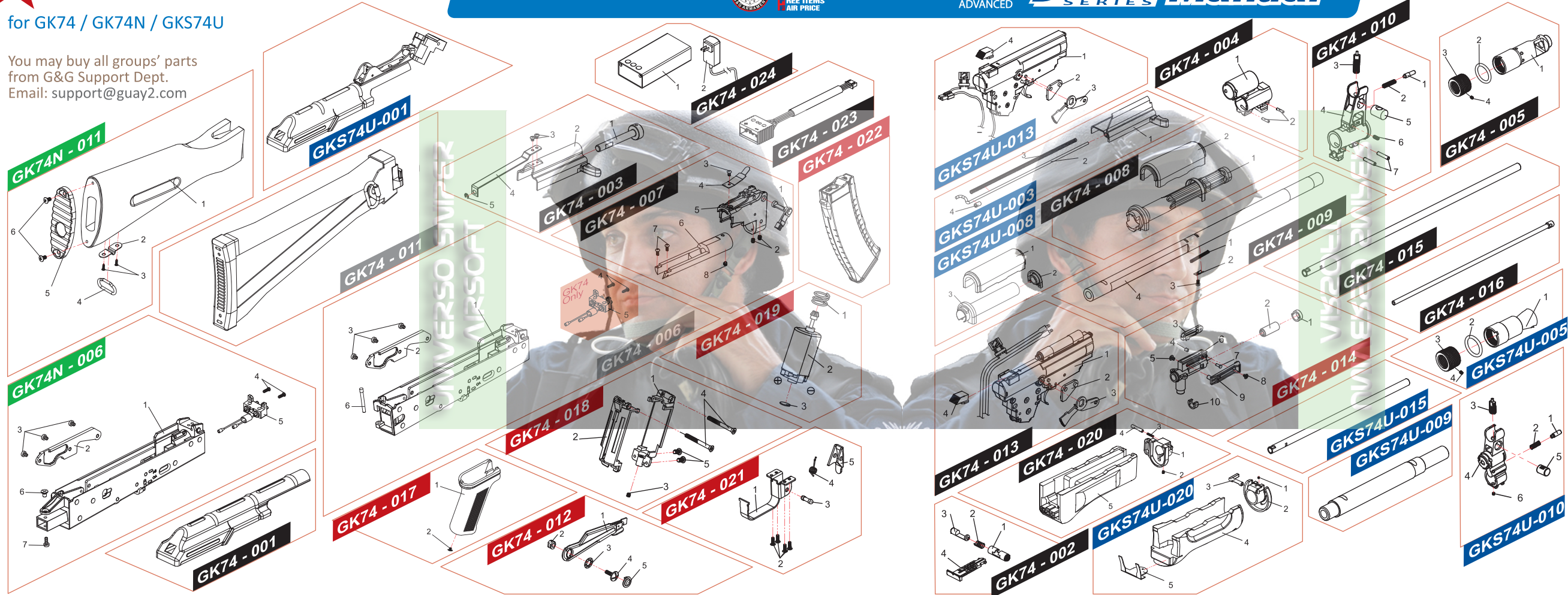

for GK74 / GK74N / GKS74U

- GK74 - 012** Selector Lever Set
- GK74 - 014** Hop Up Set
- GK74 - 017** Grip Set
- GK74 - 018** Motor Base Set
- GK74 - 019** Motor Set
- GK74 - 021** Trigger Guard Set
- GK74 - 022** Magazine

for GK74 / GK74N

- GK74 - 001** Receiver Cover Set
- GK74 - 002** Rear Sight Set
- GK74 - 003** Bolt Set
- GK74 - 004** Gas Block Set
- GK74 - 005** Flash Suppressor Set
- GK74 - 007** Barrel Base Set
- GK74 - 008** Gas Cylinder Set
- GK74 - 009** Outer Barrel Set
- GK74 - 010** Front Sight Set
- GK74 - 013** Gear Box Set
- GK74 - 015** Inner Barrel
- GK74 - 016** Clean Rod
- GK74 - 020** Handguard Battery Set
- GK74 - 023** Cord Set
- GK74 - 024** Battery Charger Set

for GK74 / GKS74U

- GK74 - 006** Receiver Set
- GK74 - 011** Folding Stock Set

for GKS74U

- GKS74U-001** Receiver Cover Set
- GKS74U-003** Bolt Set
- GKS74U-005** Flash Suppressor Set
- GKS74U-008** Gas Cylinder Set
- GKS74U-009** Outer Barrel Set
- GKS74U-010** Front Sight Set
- GKS74U-015** Inner Barrel
- GKS74U-020** Handguard Set

for GK74N

- GK74N-006** Receiver Set
- GK74N-011** Butt Stock Set



for GIMS / GKM

You may buy all groups' parts from G&G Support Dept.  
Email: support@guay2.com

for GIMS / GKM

- GIMS - 001** Receiver Cover Set
- GIMS - 002** Rear Sight Set
- GIMS - 003** Bolt Set
- GIMS - 004** Gas Block Set
- GIMS - 005** Flash Suppressor Set
- GIMS - 007** Barrel Base Set
- GIMS - 008** Gas Cylinder Set
- GIMS - 009** Outer Barrel Set
- GIMS - 010** Front Sight Set
- GIMS - 012** Selector Lever Set
- GIMS - 013** Gear Box Set
- GIMS - 014** Hop Up Set
- GIMS - 015** Inner Barrel
- GIMS - 016** Clean Rod
- GIMS - 017** Grip Set
- GIMS - 018** Motor Base Set
- GIMS - 019** Motor Set
- GIMS - 021** Trigger Guard Set
- GIMS - 022** Magazine
- GIMS - 023** Cord Set
- GIMS - 024** Battery Charger

for GIMS

- GIMS - 006** Receiver Set
- GIMS - 011** Folding Stock Set
- GIMS - 020** Handguard Battery Set

for GKM

- GKM - 006** Receiver Set
- GKM - 011** Butt Stock Set
- GKM - 020** Handguard Battery Set

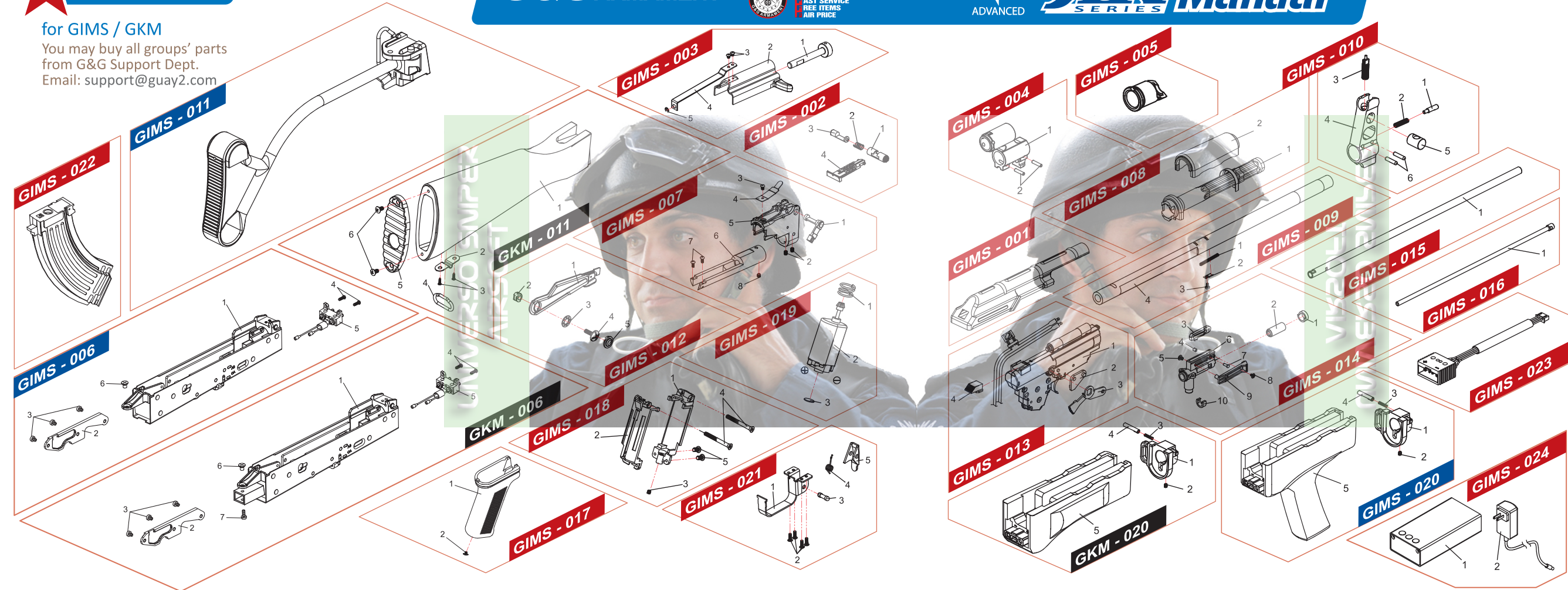

for GKMS

You may buy all groups' parts from G&G Support Dept.  
Email: support@guay2.com

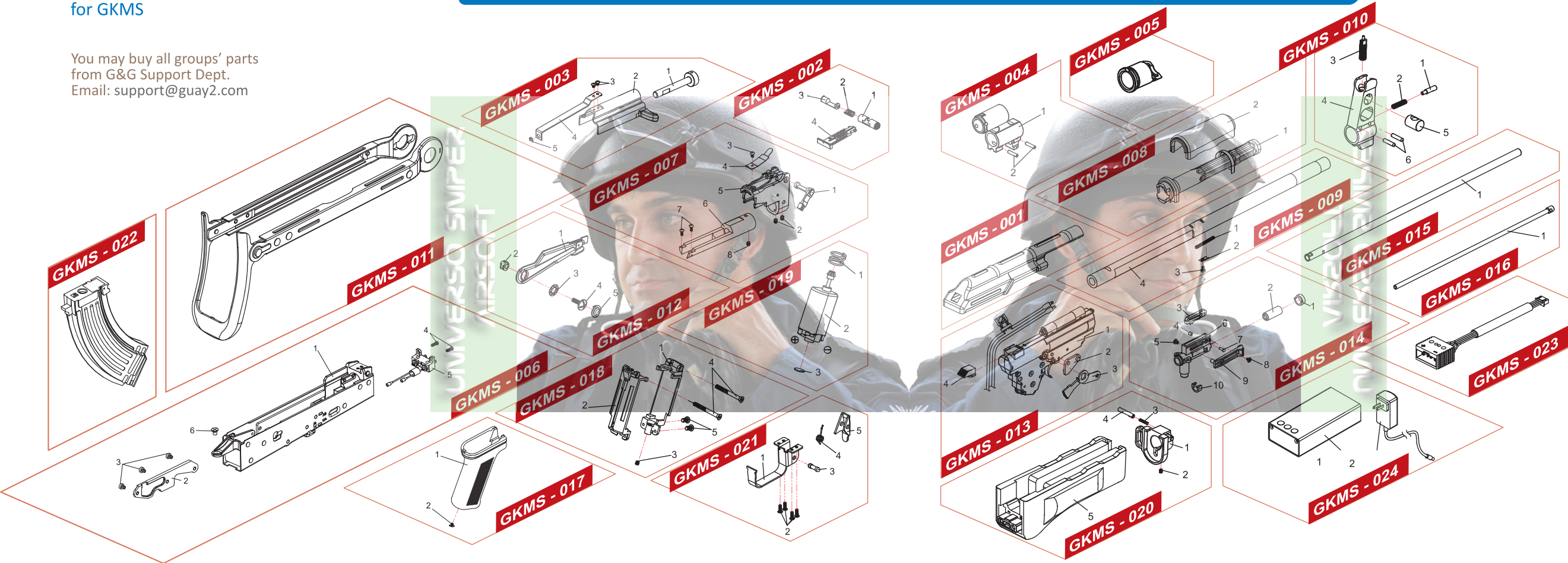

for GKMS

- GKMS - 001 Receiver Cover Set
- GKMS - 002 Rear Sight Set
- GKMS - 003 Bolt Set
- GKMS - 004 Gas Block Set
- GKMS - 005 Flash Suppressor Set
- GKMS - 006 Receiver Set
- GKMS - 007 Barrel Base Set
- GKMS - 008 Gas Cylinder Set
- GKMS - 009 Outer Barrel Set
- GKMS - 010 Front Sight Set
- GKMS - 011 Folding Stock Set
- GKMS - 012 Selector Lever Set
- GKMS - 013 Gear Box Set
- GKMS - 014 Hop Up Set
- GKMS - 015 Inner Barrel
- GKMS - 016 Clean Rod
- GKMS - 017 Grip Set
- GKMS - 018 Motor Base Set
- GKMS - 019 Motor Set
- GKMS - 020 Handguard Battery Set
- GKMS - 021 Trigger Guard Set
- GKMS - 022 Magazine
- GKMS - 023 Cord Set
- GKMS - 024 Battery Charger

You may buy all groups' parts from G&G Support Dept.  
Email: support@guay2.com



for GKMS Carbine / GK74 Carbine

You may buy all groups' parts from G&G Support Dept.  
Email: support@guay2.com

for GKMS Carbine / GK74 Carbine

- GKMS C - 01** Receiver Cover Set
- GKMS C - 03** Bolt Set
- GKMS C - 05** Flash Suppressor Set
- GKMS C - 08** Gas Cylinder Set
- GKMS C - 09** Outer Barrel Set
- GKMS C - 10** Front Sight Set
- GKMS C - 12** Selector Lever Set
- GKMS C - 13** Gear Box Set
- GKMS C - 14** Hop Up Set
- GKMS C - 15** Inner Barrel
- GKMS C - 17** Grip Set
- GKMS C - 18** Motor Base Set
- GKMS C - 19** Motor Set
- GKMS C - 20** Handguard Set
- GKMS C - 21** Trigger Guard Set

for GKMS Carbine

- GKMS C - 06** Receiver Set
- GKMS C - 11** Folding Stock Set
- GKMS C - 22** Magazine

for GK74 Carbine

- GK74 C - 06** Receiver Set
- GK74 C - 11** Folding Stock Set
- GK74 C - 22** Magazine

You may buy all groups' parts from G&G Support Dept.  
Email: support@guay2.com





# COMPONENTS

**GK74M**  
**GKG74M** CLASSIC EDITION

**GKS74**  
**GKSG74** CLASSIC EDITION

**G&G** www.Guay2.com  
**ARMAMENT**



# BATTERY & STOCK

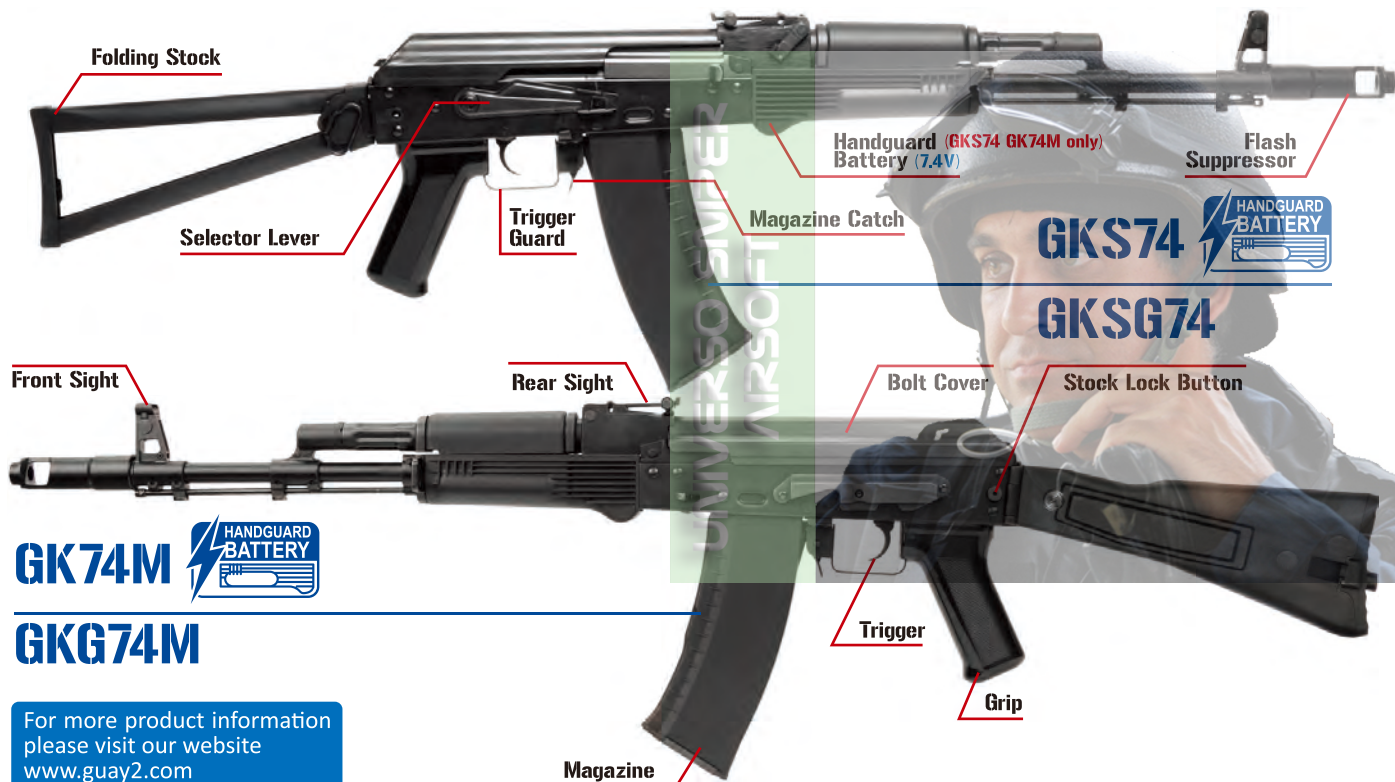

**GK74M** HANDGUARD BATTERY

**GKG74M**

For more product information please visit our website [www.guay2.com](http://www.guay2.com)

**CAUTION** Direct the muzzle towards a safe direction and set the selector to the safety position. The magazine should be removed before changing the battery.

### Battery Setting ( GKS74 / GK74M )



1. Push the button and pull forward to unlock the handguard battery.
2. Remove the handguard battery.

### Battery Setting ( GKSG74 / GKG74M )



1. Push the cover release button to remove the bolt.
2. Connect the battery unit it clicks, then put back the cover.

### Folding Stock ( GKS74 / GKSG74 )



1. Push the stock lock button to unlock.
2. Turn to fold the stock.

### Folding Stock ( GK74M / GKG74M )



1. Push the stock lock button to unlock.
2. Turn to fold the stock.

### Battery Setting ( GKS74 / GK74M )



#### LED Indication

Power : Blue Light (ON)  
 Error Status : Red Light (Flashing)  
 Normal : Red Light (OFF)  
 Fully Charged : Green Light (ON)  
 Normal : Green Light (OFF)

When the green light flashing more frequently shows the charging speed is faster. When the battery is nearly full, the green light will be on consistently.

**CAUTION** Make sure the longitudinal slits always present on pin connector. If the pin connector has been deformed, it may disable the firing function!



You can use the razor blade to expand the slit and spread the two halves of the pin to compensate for wear.



GKS74/GKSG74  
GK74M/GKG74M Manual

for GKS74 / GKSG74 / GK74M / GKG74M



- 001 Bolt Cover
- 002 Rear Sight Set
- 003 Bolt Set
- 004 Gas Block Set
- 005 Flash Suppressor Set
- 006 Receiver Set
- 007 Barrel Base Set
- 008 Gas Cylinder Set
- 009 Outer Barrel Set
- 010 Front Sight Set
- 011 Folding Stock Set
- 012 Selector Lever Set
- 013 Gear Box Set
- 014 Hop Up Set
- 015 Inner Barrel
- 016 Dummy Rod
- 017 Grip Set
- 018 Motor Mount Set
- 019 Motor Set
- 020 Handguard Battery\_GKS74/GK74M
- 021 Trigger Guard Set
- 022 Magazine
- 023 Charger Adapter\_GKS74/GK74M
- 024 Battery Charger\_GKS74/GK74M
- 025 Lower Handguard Retainer
- 026 Handguard\_GKSG74/GKG74M
- 027 Wire Set\_GKSG74/GKG74M

You may buy all groups' parts  
from G&G Support Dept.  
Email: [support@guay2.com](mailto:support@guay2.com)