

L85 SERIES

6mm Electric Semi / Full Auto System



MANUFACTURED BY GUAY GUAY TRADING CO., LTD.
WWW.GUAY2.COM
MADE IN TAIWAN



L85 SERIES

6mm Electric Semi / Full Auto System
I N S T R U C T I O N M A N U A L

WARNING HANDLING CAUTIONS & INSTRUCTION MANUAL
Always read through this manual before operation.

L85 SERIES

6mm Electric Semi / Full Auto System



CONTENTS

- P02.03.04.05 ▶ **Warning**
- P06.07 ▶ Components
- P08.09 ▶ Battery setting
- P10 ▶ Fuse type and replacement
- P11 ▶ Magazine loading
- P12 ▶ Magazine insert and release
- P13 ▶ Firing mode and safety
- P14 ▶ Install carrying handle
- P15 ▶ Install front sight
- P16 ▶ Front sight and rear sight adjustment
- P17 ▶ Grip
- P18 ▶ Hop-up adjustment
- P19.20.21 ▶ Field stripping
- P22 ▶ Bolt and spring release
- P23 ▶ SPEC.
- P24.25 ▶ **Troubleshooting**
- P26 ▶ **Caution**
- P27 ▶ G&G A.E.G. LINE



警告
WARNING

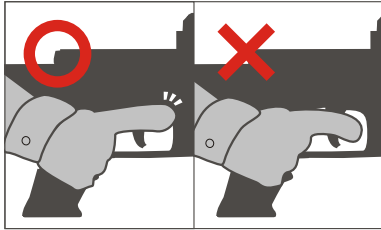

Activating the trigger carelessly is extremely dangerous. Never put your finger onto the trigger unless the safety cap is removed and you are ready to shoot a target.

警告
WARNING

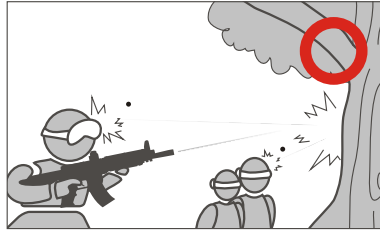

When shooting the air guns for target practice or in a game situation, you and all participants must wear goggles or other eye protective gear. Also, pay attention to ricochets. It is important to pay attention to third parties other than the participants.

警告
WARNING

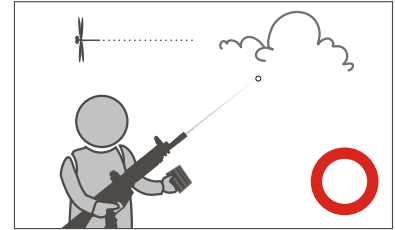

There may be cases where some BBs remain in the gun after the magazine has been disconnected. After removal of the magazine, direct the muzzle towards a safe direction and pull the trigger to confirm that no BBs remain in the gun, then attach the safety cap.

P.02

P.03

警告
WARNING

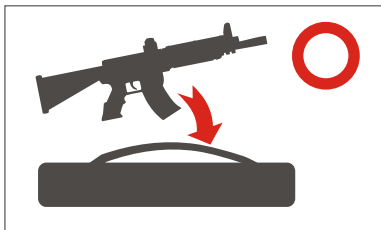

When you carry the air gun, attach the safety cap, set the selector lever to the safety position and always put it in a case or bag.

警告
WARNING

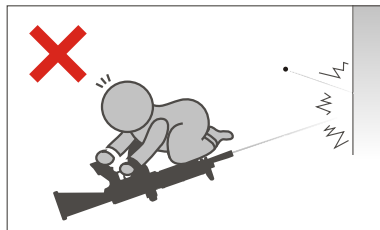

Always attach the safety cap to the muzzle, remove the battery and store the air gun in a case or bag and at a place out of reach by children.

警告
WARNING

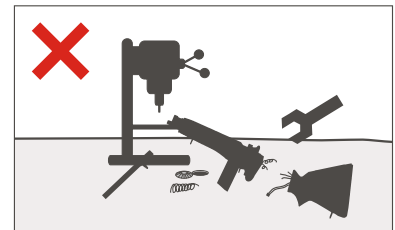

Disassembling or modifying the gun may adversely affect the performance and make it dangerous.

WARNING

HANDLING CAUTIONS & INSTRUCTION MANUAL
Always read through this manual before operation.

G&G ARMAMENT
AIRSOFT GUNS & ACCESSORIES

警告
WARNING

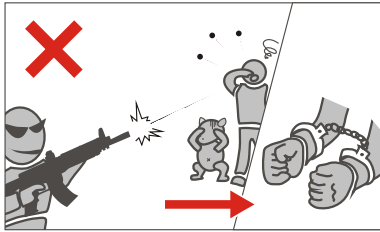

You may be liable for damaging public or personal property or for injuring a person or an animal even if you only meant to shoot as a "practical joke". Always observe good manners and enjoy fun sport shooting.

警告
WARNING

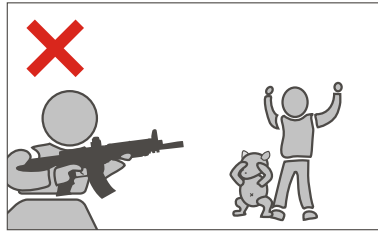

Never direct the muzzle towards a person, animal or in any other dangerous direction.

警告
WARNING

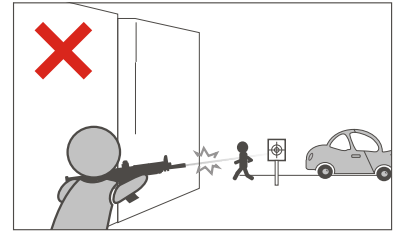

Select a safe place for operating the air gun, avoiding places where people and cars pass cross or third persons are around.

P.04

P.05

警告
WARNING

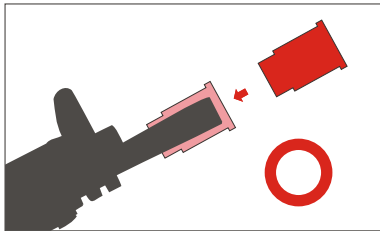

Make sure to attach the barrel and safety cap to the muzzle, except when you are shooting. Do this to prevent accidental, sudden discharge and also for dust protection purposes. NEVER pull the trigger while the barrel and the safety cap is attached.

警告
WARNING

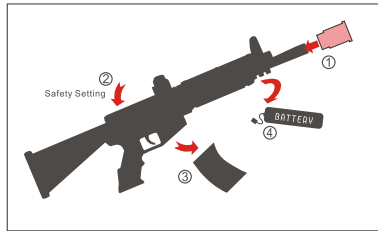

Safety procedure:
1 - Attach the safety cap to the muzzle.
2 - Set the selector lever to the safety position.
3 - Remove the magazine.
4 - Remove the battery.

警告
WARNING

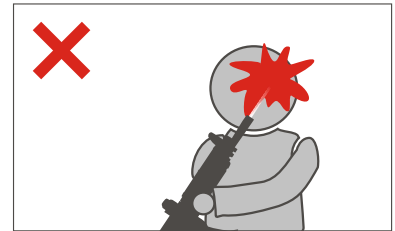

Looking into the muzzle is extremely dangerous regardless of BB's having been loaded or not. If you get hit in the eye by a BB bullet, you may in worst case, loose your eye sight.

WARNING

HANDLING CAUTIONS & INSTRUCTION MANUAL
Always read through this manual before operation.

L85 SERIES ■ Components

6mm Electric Semi / Full Auto System

G&G ARMAMENT
AIRSOFT GUNS & ACCESSORIES

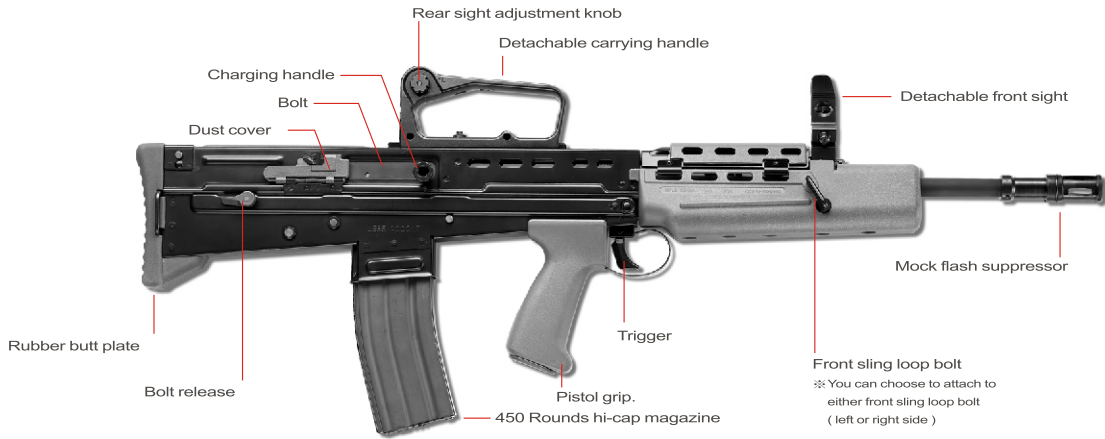

P.06



P.07

G&G ARMAMENT
AIRSOFT GUNS & ACCESSORIES

■ Components **L85 SERIES**
6mm Electric Semi / Full Auto System



Open the upper handguard cover.

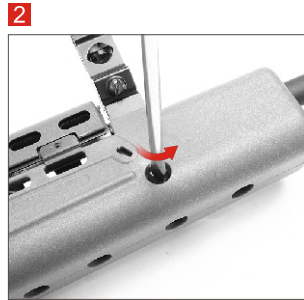

1. Unscrew the Front sling loop bolt.
2. Take off the Front sling loop.



Remove the left side handguard.

P.08



Connect battery plug with the connector.
Insert the battery into the left side of the handguard properly.



Re-attach left side handguard and close the upper handguard cover.

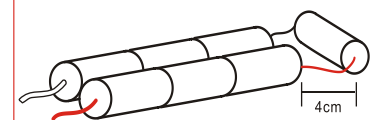

Recommended battery type:
8.4V 1800mAh Ni-Cd rechargeable battery

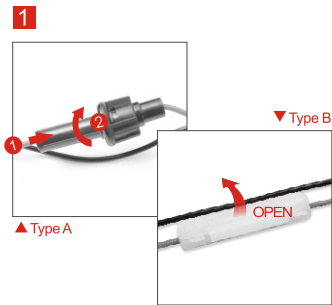

Open the fuse case.

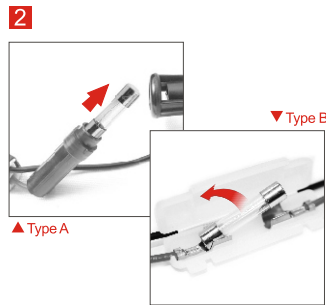

Replace the fuse.

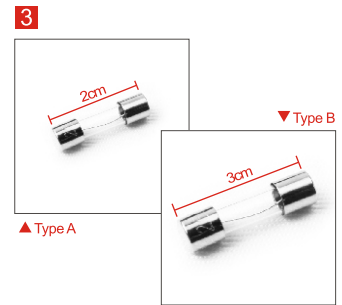

Type A : Glass tube fuse 20A.
Type B : Glass tube fuse 15A.

P.10

P.11



Open the cover on the top of the magazine.



Feed the BBs.



Close the cover and turn the gear at the bottom all the way until the sound changes.



To insert the magazine :
insert the magazine upward and connect firmly till a "CLICK" sound is heard.

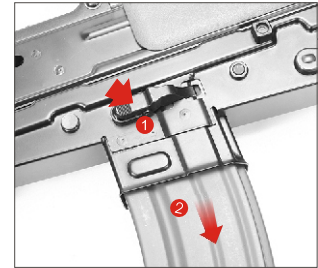
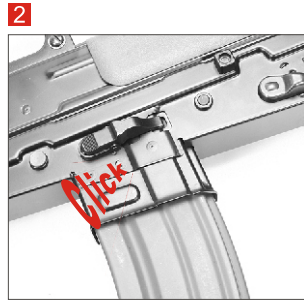

To release the magazine :
hold the magazine then push the magazine release button and pull the magazine out.

P.12

P.13



The upper position "R" is semi auto, one shot each time when the trigger is pulled.
"A" is for "automatic"
Automatic firing when trigger remains pulled.



Safety on:
Trigger can not pulled and gun will not fire.





1. Open the upper handguard cover.
2. Install the carrying handle on the upper receiver.

P.14



1. Look on top of the carrying handle there are two holes.
2. Look through the first hole and align it with the corresponding hole on the upper receiver, then fasten the screw on top.



Fasten the screws on the side.

P.15

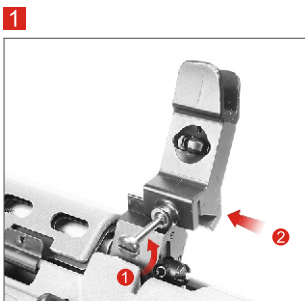

1. Unscrew the fixing screw with a screwdriver.
2. Install the front sight.

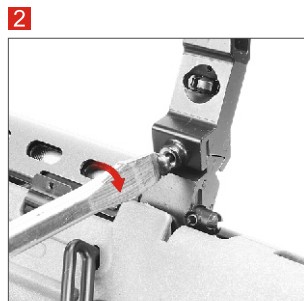

Fasten the screw.



Finish.

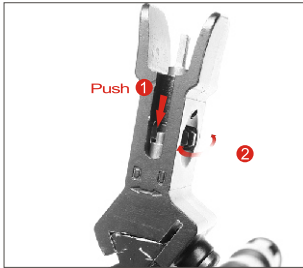

Front sight :
Push down the front sight knob pin.
Turn the knob to adjust the front sight.

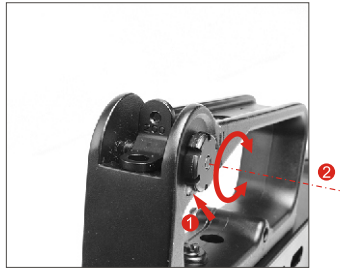

Rear sight :
Push down the rear sight knob pin.
Turn the knob for rear sight
left / right adjustment.

Battle sight (flip manually)



For precision shooting.



For normal shooting.

P.16

P.17



Grip storage space for tool kit.

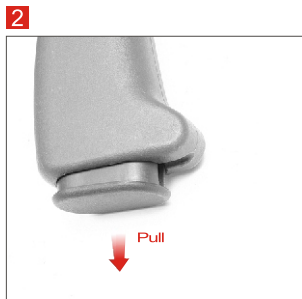

Pull out the pistol grip plug.



L85 SERIES

6mm Electric Semi / Full Auto System

■ Hop-up adjustment

G&G ARMAMENT
AIRSOFT GUNS & ACCESSORIES



1 Pull the charging handle backward to open the dust cover.



2 Push down the bolt lever to hold the bolt in place.



3 Turn the adjust dial to change the hop-up effect

P.18

P.19

⚠ WARNING !! Before the Field stripping

1. Check the gun a safety direction and remove magazine.
2. Place the safety on "safe mode".
3. Pull the charging handle all the way to the rear, and inspect the chamber to ensure it is empty.
4. Do not operate the trigger, leave the hammer cocked and the gun on safe.

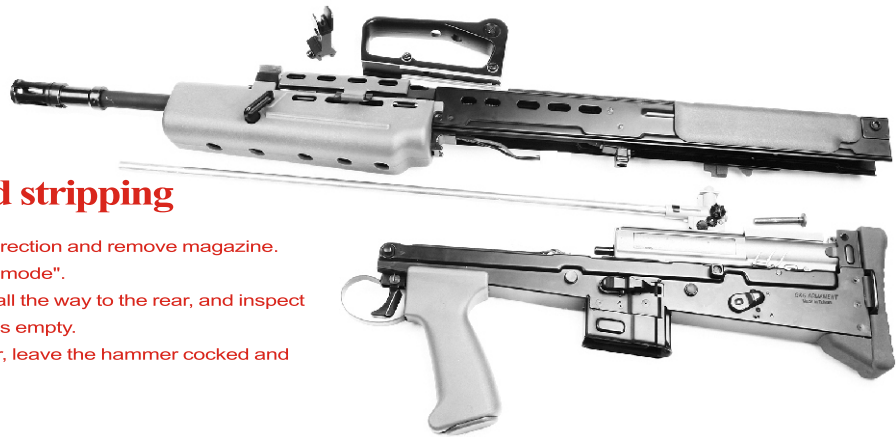

G&G ARMAMENT
AIRSOFT GUNS & ACCESSORIES

■ Field stripping **L85 SERIES**
6mm Electric Semi / Full Auto System

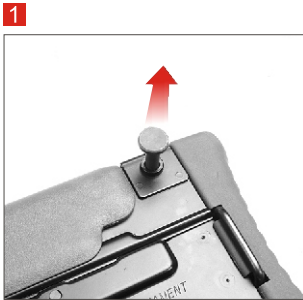

Pull the receiver takedown pin out.
(if may be easier to first push the pin hard
from the other side of the upper receiver)

P.20



Move the upper receiver forward until it is separated from the lower receiver.

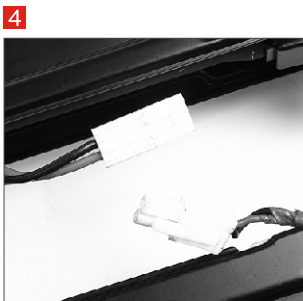
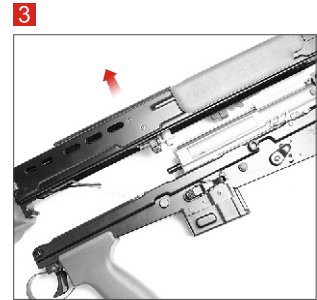

Release the connectors.



Pull the hop-up unit and inner barrel out.



Finish.

P.21

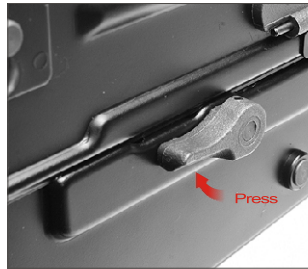

Press the lever to release the bolt.

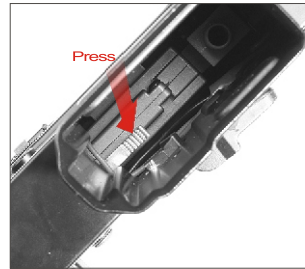

Press the lever to release the spring.

P.22

P.23

▪ L85 A1 SPEC.





- Inner barrel length : 510mm
- Overall length : 785mm
- Weight : 3780g
- Built material : Steel / Magnesium
Nylon / Zinc / Al6061
Rubber
- Magazine capacity : 450 Rounds (standard)
- Muzzle velocity : 80 m/sec with 0.2g BB



WARNING

1. Use the correct battery type which the instruction manuals suggest.
We will not be held responsible for any accident or damage caused by wrongful operation or usage of non-specified batteries.
2. To follow the operation step according to instruction.
3. Never disassemble or modify the gun.
4. Use of poor quality BB bullets will cause problems.
5. When a problem occasion please check the steps below, If that does not solve your problem, please turn to a local dealer for help or contact us at G&G

TROUBLESHOOTING To dismiss the easy bugs

SYMPTOM	CAUSE	SOLVING
No operation at all	Battery is not charged	Charged the battery
	The  and  connector is reversed	Connect the connector in right way. (see page 8 and page 9)
	Fuse is damaged	Replace the fuse. (see page 10)
	Motor is not moving	Replace the motor or check and replace the electrical connector. (Purchasing from your dealer or G&G)
	Motor is damaged	
Gun can't fire	BBs are jammed in the chamber	Stop pulling the trigger immediately and take out the magazine to clean out any BBs that are jammed. Use the cleaning rod and clean out any left over BBs. Make sure there are no left-over BBs inside the hop-up rubber.
	Faulty gear	Replace the replacement gear. (Purchasing from your dealer or G&G)

P.24

P.25

Malfunction of full auto operation	Insufficient battery power	Charged the battery
	Magazine can't load the BB smoothly	Hit the magazine lightly or replace it with another one.
	Poor electrical connection	Check and replace the electrical connector. (Purchasing from your dealer or G&G)
	Cycles become slow	Charged the battery.
Malfunction of semi auto operation	Insufficient battery power	Charged the battery
	Deviation in gear timing	Set firing mode to semi auto after firing 5-10 BBs, then set to semi auto mode.
	Poor electrical connection	Check and replace the electrical connector. (Purchasing from your dealer or G&G)
Shooting distance becomes shorter.	Damaged or worn chamber set	Replace the replacement parts. (Purchasing from your dealer or G&G)
	Damaged or worn piston set (O-ring, piston spring)	
	Something is jammed in the Inner barrel	Use the cleaning rod and clean the inner barrel.
Shooting distance becomes shorter	Inner barrel is full of oil, or something is jammed	Use the cleaning rod and clean the inner barrel.
	Inner barrel scrape is damaged	Replace the replacement parts. (Purchasing from your dealer or G&G)
	Damaged or worn chamber set	
If the gun gets wet	Stop the operation immediately, disconnect the battery and field stripping the gun. Wipe off water from inside the receiver, motor, gear box and other parts, then wait complete drying for the gun. Trial to firing, if there is no operation or malfunction is detected, please consult your dealer or G&G for repair.	

CAUTION

Always attach the safety cap and disconnect the magazine to avoid sudden operation upon connecting the battery.

Be careful so as not to hurt your fingers in the movable parts.

Always set the lever to "safe" before firing.

Do not disassemble beyond what is necessary, or the gun may be damaged.

Always use "G&G ARMAMENT" BBs for this gun. We shall not be held responsible for any damage or accidents arising from the use of bullets supplied by other manufacturers.

Since a tight barrel is used, use of dirty BBs or those with burrs causes jamming and possible fatal damage to the gear box.

Turning hop-up dial excessively causes clogging of BBs in the hop-up chamber. Continuous pulling of the trigger with clogged BBs will damage the piston and the gears.

Never hold the gun sideways as BBs will curve right or left.

We shall not be held responsible for any damage or accidents arising from the wrong operation or modification of the gun.

Disassembly is designed for appropriate maintenance, not for modification.

P.26



G&G ARMAMENT
AIRSOFT GUNS & ACCESSORIES

6mm Electric Semi / Full Auto System

MANUFACTURED BY GUAY GUAY TRADING CO., LTD. WWW.GUAY2.COM MADE IN TAIWAN

GR16 PLASTICA SERIES

GR16 CARBINE
GR16 A2
GR16 A2 CARBINE
GR16 A3
GR16 A3 CARBINE
GR16 R4
GR16 R4 CARBINE
GR16 R5

GR16 SG SERIES

GR16 CARBINE
GR16 A2
GR16 A2 CARBINE
GR16 A3
GR16 A3 CARBINE
GR16 R4
GR16 R4 CARBINE
GR16 R5

GR25 SERIES

GR25 SNIPER
GR25 S.P.R.

GR300 SERIES

GR300 SP
GR300 LP

RK SERIES

RK 103
RK 104

S.M.G SERIES

UMG
PMS A4
PMS A5

FS51 FIXED STOCK
FS51 FOLDING STOCK

L85 SERIES

L85 A1
L85 A1 CARBINE
L85 A2
L85 A2 CARBINE

FOURTEEN SERIES

FOURTEEN BLACK STOCK VERSION
FOURTEEN IMITATION WOOD STOCK VERSION
FOURTEEN WALNUT WOOD STOCK VERSION
FOURTEEN WALNUT WOOD STOCK VERSION
RIFLE TYPE 57 IMITATION WOOD STOCK VERSION
RIFLE TYPE 57 WALNUT WOOD STOCK VERSION
S.O.C.16
FOURTEEN EVOLUTION VERSION

P.27





G&G ARMAMENT
AIRSOFT GUNS & ACCESSORIES
WWW.GUAY2.COM
MANUFACTURED BY GUAY GUAY TRADING CO., LTD.
MADE IN TAIWAN

P.28

DEALER

PDF POR SNIPER, MATADORES AIRSOFT CLUB

www.matadoresairsoft.com

Please consult your dealer or G&G for overhaul maintenance and technical guidance.



DISCLAIMER

- Accessories pictured are not always included with product.
- Adult supervision required for users under 18 years of age.
- The purchaser and user should conform to all laws governing and ownership of airsoft guns.
- All products in this catalog are imitation firearms and are not intended nor represented to be comparable in design, appearance, or function to any actual firearm offered by other manufacturers.
- Product names are trademarks of Guay Guay Trading Company (G&G), which has no affiliation to, and is not associated, or sponsored by any other manufacturer of actual or imitation firearms. Products may vary from those pictured.