

T3-K1

Electromotion pneumatic gun make use of enchiridion 电动气枪使用手册

T3-K1 Profile 外形

Specrication: 规格

Data of T3-K1 Electric Air Gun 电子气枪的数据	
型名 Name	T3-K1
全长 Overall length	1040mm
重量 weight	3200g 3200 g (including battery)
枪管长 Barrel length	506mm
装弹数 Bullet capacity	500 500 rounds
弹丸 Bullet	6mm BB 6mm BB bullet
初速 Initial bullet speed	338fps/ (use0.2g bullet) 338fps/ (use0.2g bullet)
连射速度 Auto firing speed	750~850 750 to 850rounds/min (with 8.4Vbattery)

Data of Actual G3 SG/1 Gun 真枪的数据	
型名 Name	G3 SG/1
全长 Overall length	1.040mm
重量 weight	5.200g
枪管长 Barrel length	450mm
装弹数 Bullet capacity	20 20 rounds
弹丸 Ammunition	7.62 x 51mm
初速 Initial bullet speed	800 米/秒 800 m/sec
连射速度 Auto firing speed	550~600 550 to 600 rounds/min

Description:

描述

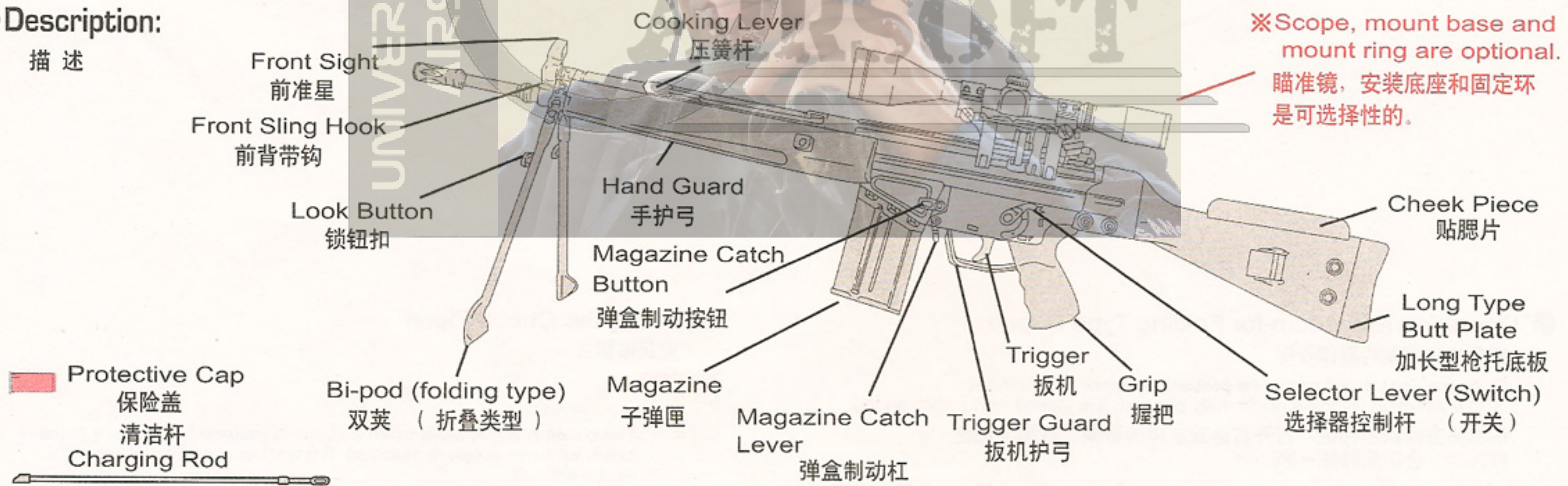

Optional Parts 可选零件

- Scope 3x20(Short) 瞄准镜3 x20 (短型)

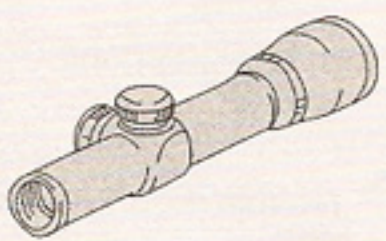

- Scope 40x40(Long) 瞄准镜40x40 (长型)

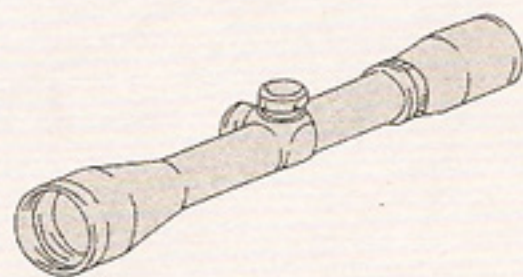

- Mount Ring Set 固定环套件

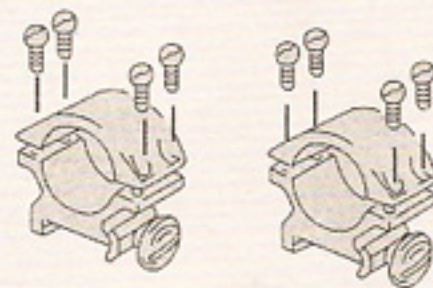

- Scope Mount Base Common for MP5/T3 Series M5/T3系列通用的瞄准镜安装底座。

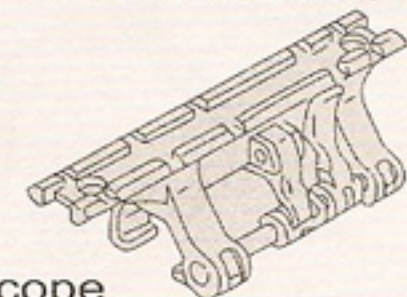

- Purchase the optional parts at a gun, toy or model shop. 在枪店、玩具店或模型店购买可选零件。

- If not available because of short supply, consult our Parts Supply Dept. directly. 如果由于供应短缺而购买不到, 请直联系我们。

- ※ Select your favorite scope. 选择你最喜欢的瞄准镜。

- ※ For the installation procedure, refer to the respective instruction manual. 关于安装步骤, 请查阅各自的使用说明书。



T3K1 DETAIL LIST

T3K1 零件清單

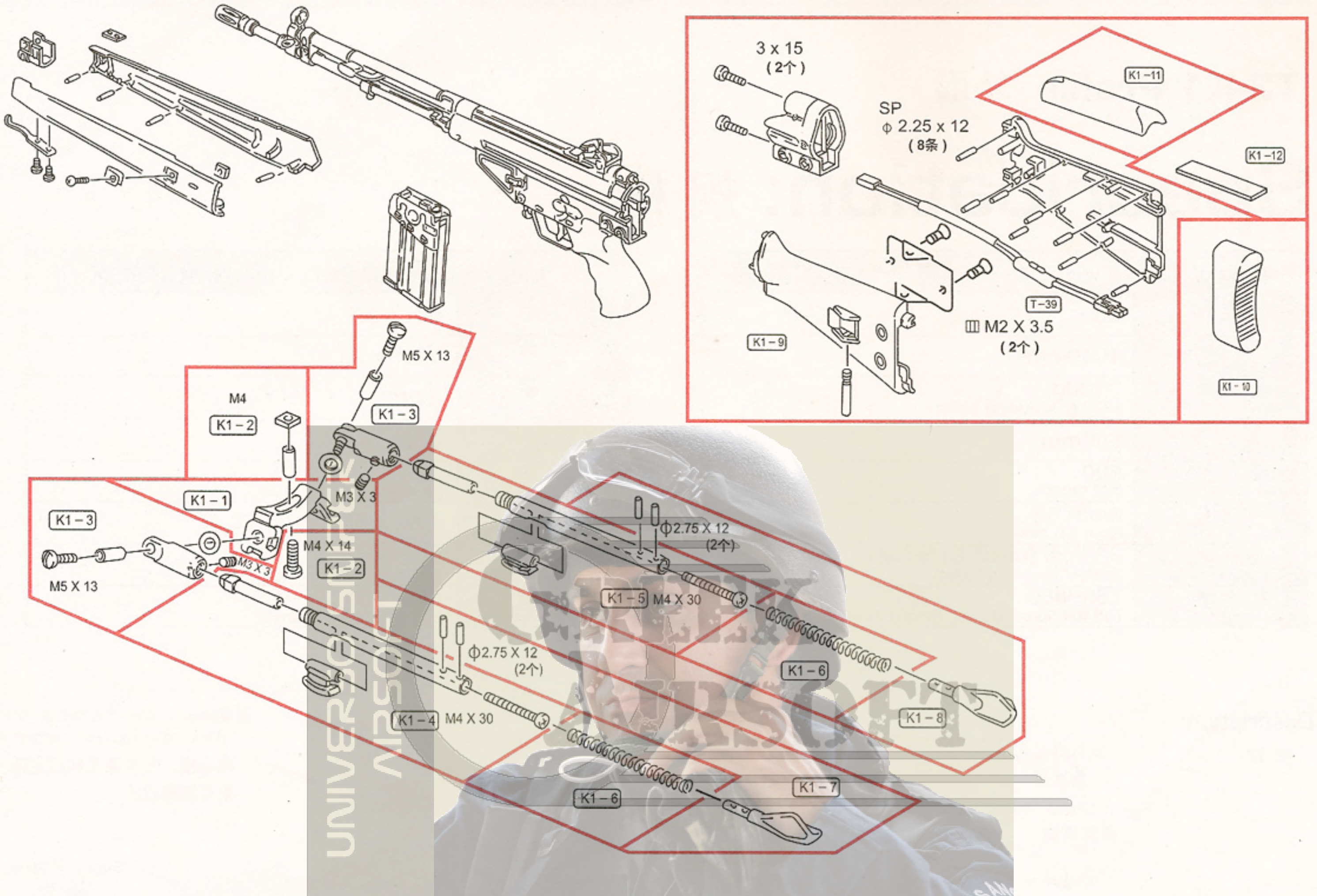

● Operation Procedure for Folding Type Bi-pod 折叠式双脚架的操作步骤

① Open the right or left pod while pressing the lock button in the arrow direction. When a pod is fully opened, it is locked with a click sound.

按箭头方向按紧锁键，打开右边或左边的脚架。当脚架完全打开时，会听到咔嚓一声。

② When a pod is fully open, it can be swung freely to the right or left as shown, which is a useful function for operation on uneven ground.

如图所示，当脚架完全打开时，可自由地向右或向左旋转。该功能对于在不平坦的地面上的操作非常有用。

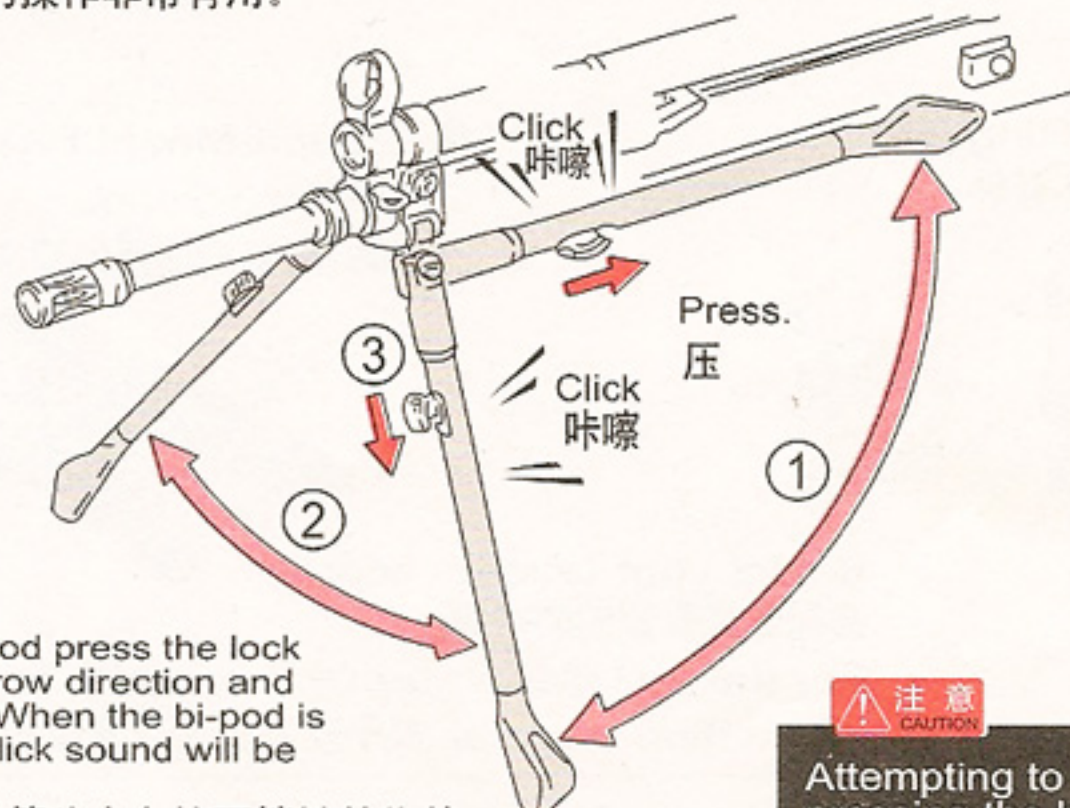

② To store the bi-pod press the lock button in the arrow direction and fold it upwards. When the bi-pod is fully closed, a click sound will be heard.

存放双脚架：按箭头方向按下锁键并将其向上折叠起来。当双脚架完全折叠好时会听到咔嚓一声。

● Fixing the Cheek Piece 安装贴腮片



The cheek piece is used when a scope is mounted. If a cheek piece exists while no scope is mounted, the normal operation of the sight will be difficult.

安装上瞄准镜后，贴腮片才能使用。如果没有安装瞄准镜，就装上贴腮片，瞄准器将很难进行正常操作。

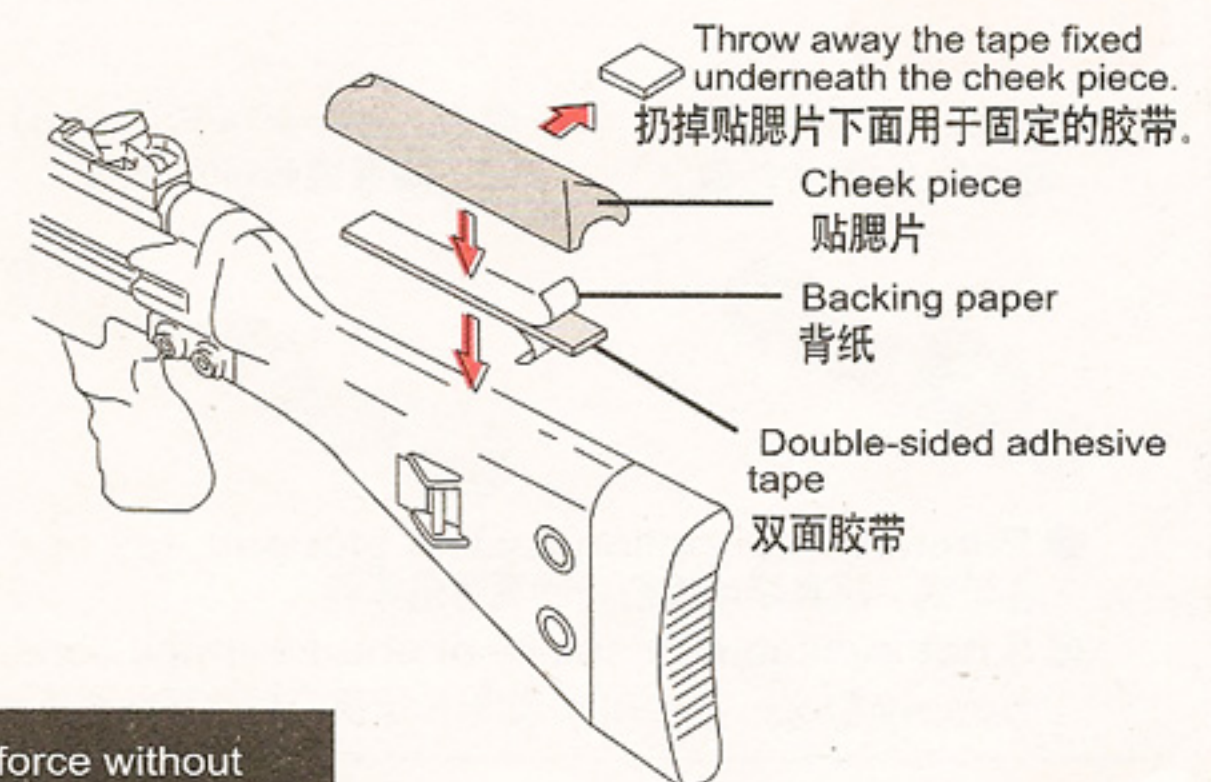

Attempting to open the bi-pod by force without pressing the button will damage it.
如果不按下按键而强行打开双脚架，将会损坏该脚架。