

SKU: 104-01503

KWA PERFORMANCE INDUSTRIES

QRF MOD.3 OPERATION MANUAL

QRF
MOD.3



QRF MOD.3

OPERATION MANUAL

KWA[®]
KWA-USA.COM

USE OF THIS MANUAL

Before operating your KWA product, read this manual in its entirety. Important safety topics and tips are discussed throughout all of the chapters. It's important that the operator know the principles of gun handling, safety, and operation prior to attempting to operate an airsoft product.

SAFETY GUIDELINES

Safety Distance

The effective shooting range of this product is approximately 175 feet. BBs fired from this airsoft rifle may travel farther than intended. Make certain that you have an adequate backstop.

Eye Protection

Eye protection should be worn at all times when either using or conducting maintenance and cleaning on your airsoft product.

Assume Every Gun is Always Loaded

This is the first rule of gun safety, so don't forget it! Treat every gun as if it were loaded, all the time. Never assume that the chamber is empty based on your memory or someone else's word. Always remove the magazine and visually check to confirm that the chamber is empty, and that there is no power present (battery or gas) in the airsoft product before beginning cleaning or maintenance.

Beware of Barrel Obstructions

Ensure that the airsoft product's barrel is free of obstructions before you fire the gun. Even the smallest obstruction such as dirt, dust, or a stuck cleaning patch can cause a jam, misfire, or malfunction.

Muzzle Control

Always keep the muzzle of the gun pointed in a safe direction. Never point the muzzle at a person or object that you do not intend to shoot.

Keep Your Safety On

ALWAYS keep the muzzle of the gun pointed in a safe direction. NEVER point the muzzle at a person or object that you do not intend to shoot.

Keep Your Finger Off The Trigger

Keep your finger off of the trigger and out of the trigger guard until your sights are aligned on your target and you are ready to fire.

Identify Your Target and Backstop

Before you pull the trigger, make certain of your target and what is beyond it. The Airsoft gun should never be fired at surfaces such as rocks, glass, water, or other hard surfaces where BBs are likely to ricochet in unpredictable directions.



WARNING:

- Airsoft BBs can be a choking hazard. Keep them away from children.
- Failure to follow safety guidelines may result in serious injury.

SAFETY GUIDELINES (CONTINUED)

Failure To Fire

If the airsoft gun fails to fire, misfires, or malfunctions, do not look into the gun barrel. BBs may be lodged in the chamber, and serious eye injury may occur if the BBs are expelled suddenly. Remove the battery/gas, and safely attempt to dislodge the obstruction.

Maintain Your Gun Properly

Performing proper maintenance, as outlined in this manual, ensures that your airsoft gun will be safe to shoot and will perform to its designed specifications for many years. Alterations, modifications or adjustments may damage your airsoft gun, make it unsafe to shoot, and will immediately void all warranty claims with KWA.

Store Your Gun Safely

Always store the airsoft gun in a safe place, and out of reach of children. Keep the safety engaged, and remove the magazine, and any batteries or gas before storing your product over any extended amount of time.

NOTE: IT IS YOUR RESPONSIBILITY TO TAKE EVERY REASONABLE PRECAUTION TO ENSURE THE SAFE STORAGE AND TRANSPORTATION OF YOUR AIRSOFT GUN.

Orange Tip

The orange tip on Airsoft guns help Law Enforcement distinguish the replica guns from their real firearm counterparts. Altering the coloration or markings required by state or Federal law so as to make the product look more like a firearm is dangerous and may be a crime. Operator assumes all risks and responsibility when doing so.

Hazards of Being Mistaken for a Real Firearm

Airsoft guns have been mistaken by Police and Law Enforcement as real firearms. A confrontation with law enforcement while carrying an airsoft gun can result in serious injury or even death. It is strongly advised to operate this airsoft product at a safe and legal location. In the event that you are approached by Law Enforcement personnel, you must comply with their instructions immediately to avoid an incident. Always transport any airsoft products in a carrying case and never display them in a public place.

Alcohol, Medications, and Drugs

Do not handle or operate your airsoft gun while under the influence of alcohol, medication or drugs.

Your Responsibility

Your KWA product is well-engineered and manufactured to the highest standards. It was carefully inspected before it was packaged and shipped from our factory. Its safe use depends on you alone. You are the ultimate safety device. Like many other devices, your airsoft gun is safe unless handled in an irresponsible or uneducated manner.



WARNING:

- Adult supervision is required for any person under the age of 18.
- Alterations and/or modifications to your KWA airsoft gun will void all warranty claims.



KWA PERFORMANCE INDUSTRIES, INC.
18571 E. Gale Ave.
City of Industry, CA 91748
(626) 581-1777

WARRANTY

THANK YOU FOR PURCHASING A KWA PERFORMANCE INDUSTRIES, INC. PRODUCT. KWA Performance Industries, Inc. is committed to serving our customers with the finest quality products, the highest level of service, and the best customer satisfaction. Because of this, we offer a 90 day warranty on KWA products sold by us and our KWA Authorized Resellers.

Warranty Coverage

Except as specified below, this warranty covers all defects in material and workmanship in KWA products that occur during the above warranty period. The following are not covered by the warranty: (1) Any product which is not imported and distributed in the U.S.A. by KWA PERFORMANCE INDUSTRIES, INC. (2) Any products not purchased in the U.S.A. from a KWA AUTHORIZED RESELLER. If you are uncertain as to whether a reseller is a KWA AUTHORIZED RESELLER, please contact KWA PERFORMANCE INDUSTRIES, INC. as listed above or visit our website at www.kwausa.com to contact us. (3) Damages, deterioration, or malfunction resulting from: a) An accident, act of nature, abuse, misuse, neglect, opening of mechbox, or failure to follow instructions supplied with the product. b) Repair or attempted repair by anyone other than KWA PERFORMANCE INDUSTRIES, INC. (4) Products that are used outside the U.S.A. (5) Products damaged by damaged or incorrect batteries, (6) Products that have been used with low-grade or used ammo (BBs), (7) Products that have been used with non-approved propellants (ie. Propane, Red/Black Gas, 134a... etc.) (6) Products used in industrial, commercial, and/or professional applications. Products used as rental units are considered commercial units and carry no warranty with KWA.

What KWA Will Pay For

If your KWA product is found to be defective by KWA Performance Industries, Inc. during the applicable warranty period (which begins from the date of original purchase), KWA Performance Industries, Inc. will repair, or at its option, replace with a new, used, or equivalent model, the defective product without charge for parts or labor. Proof of purchase must be present for the warranty to be honored.

How To Obtain Warranty Service

If your product needs service, it may be taken or shipped to KWA Performance Industries, Inc. The following procedures apply whenever your unit must be transported for warranty service:

- You must go to the RMA Request link at www.kwausa.com to obtain an RMA number. THE RMA NUMBER MUST BE CLEARLY MARKED ON THE OUTSIDE OF THE PACKAGE. PACKAGES WITHOUT AN RMA NUMBER CLEARLY MARKED WILL BE REFUSED AND RETURNED TO THE SENDER.
- You are responsible for transporting your unit or arranging for its transportation.
- If shipment of your unit is required; you must pay the initial shipping fee, but we will pay the return shipping charge if the repairs are covered by the warranty
- WHEN RETURNING YOUR UNIT FOR WARRANTY SERVICE, A COPY OF THE ORIGINAL SALES RECEIPT MUST BE ATTACHED.
- You must include the following: RMA number, your name, address, daytime telephone number, model and serial number (if applicable) of the product and a description of the problem.



This Warranty is Only Valid in the United States

If your product does not require service, but you have questions regarding its operation, please contact our Customer Service Team at www.kwausa.com.

THIS WARRANTY IS EXPRESSLY MADE IN LIEU OF ALL OTHER WARRANTIES, EXPRESSED OR IMPLIED, INCLUDING WITHOUT LIMITATION, WARRANTIES OF MERCHANTABILITY AND FITNESS FOR A PARTICULAR PURPOSE.

OUR LIABILITY IS LIMITED TO THE REPAIR OR REPLACEMENT, AT OUR OPTION, OF ANY DEFECTIVE PRODUCT AND SHALL IN NO EVENT INCLUDE INCIDENTAL OR CONSEQUENTIAL COMMERCIAL OR PROPERTY DAMAGES OF ANY KIND. WE ARE NOT RESPONSIBLE FOR PRODUCTS LOST, STOLEN AND/OR DAMAGED DURING SHIPPING.

SINCE SOME STATES DO NOT ALLOW LIMITATIONS ON HOW LONG AN IMPLIED WARRANTY LASTS AND/OR DO NOT ALLOW THE EXCLUSION OF INCIDENTAL OR CONSEQUENTIAL DAMAGES, THE ABOVE LIMITATIONS AND EXCLUSIONS MAY NOT APPLY TO YOU.

This warranty gives you specific legal rights, but you may also have other rights which vary from state to state. This warranty may not be altered other than in writing signed by an officer of KWA Performance Industries, Inc.

QRF MOD.3 RIFLE SPECIFICATIONS

The third iteration of the KWA QRF is upon us. Internally, the Mod 3 shares all the same features as its numerical counterparts, but the outside is a whole different animal. The vertical magazine design of the QRF Mod 3 is reminiscent of modern Pistol Caliber Carbines and a slightly flared magazine well aids in dynamic reloads.

Adjust your FPS to match your current mission parameters using KWA's Variable Performance System featured in all KWA AEG 2.5+ gearboxes. Elevate your Mod 3 to Tier One Operator levels by installing your favorite MOSFET such as Gate Titan. Standard issue PTS Enhanced Back Up Iron Sights and Enhanced Polymer Grip along with KWA's Tanker/PDW Stock and 6" Tactical M-LOK handguard round out the Mod 3 load out. Grab your squad, check your coms, choose a landing spot and collect some bounties with the KWA QRF Mod 3.



SPECIFICATIONS

LENGTH (RETRACTED):	21.75"	552.45 MM
LENGTH (EXTENDED):	26.50"	673.10 MM
HEIGHT:	9"	228.60 MM
OUTER BARREL LENGTH:	6.75"	171.45 MM
INNER BARREL LENGTH:	7.25"	184.15 MM
MAGAZINE CAPACITY:	80	
WEIGHT:	6.0 LBS	2.72 KG
RATE OF FIRE:	19+	
VELOCITY:	~ 320 FPS MIN ~ 360 FPS MAX, ADJUSTABLE FPS	
POWER SOURCE:	NIMH OR LI-PO/LI-FE (DEANS/T-PLUG)	

1 -THE BASICS

Prepare your gun for operation by removing the collapsible tanker/PDW style stock. Fully extend the butt stock assembly to the longest position and then depress the button on the underside of the stock housing. Once the butt stock is removed, you can then remove the battery cover plate by pushing down on the tab and pulling out.

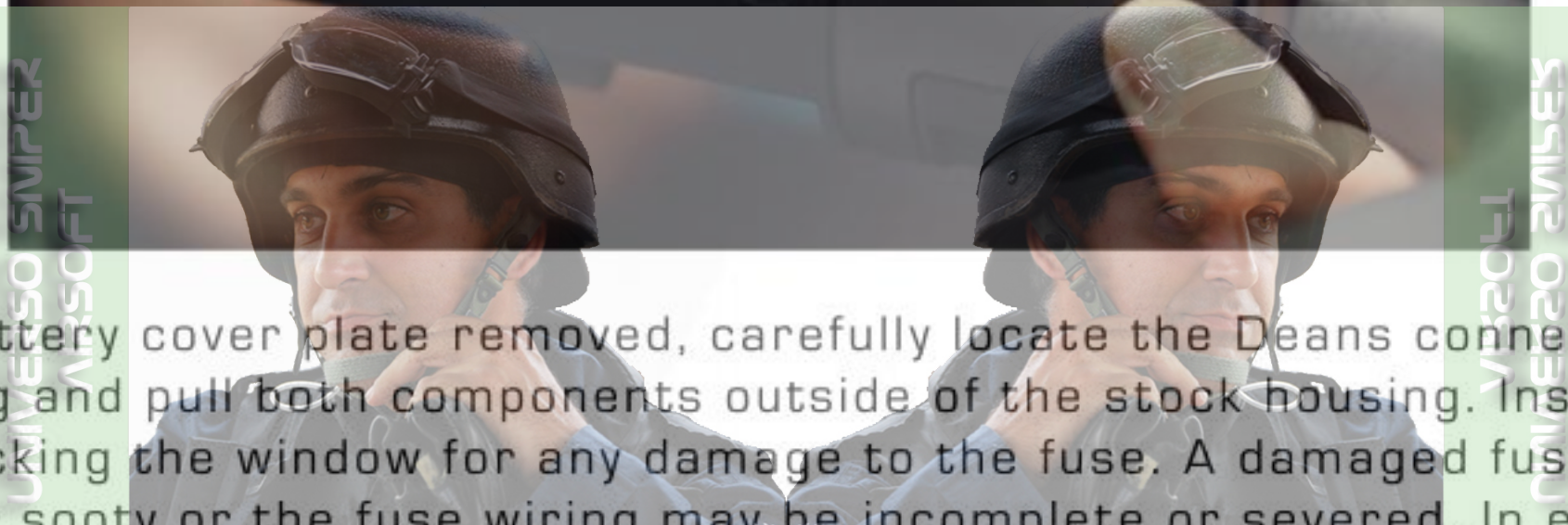

With the battery cover plate removed, carefully locate the Deans connector and fuse housing and pull both components outside of the stock housing. Inspect the fuse by checking the window for any damage to the fuse. A damaged fuse will either look dirty or sooty or the fuse wiring may be incomplete or severed. In either case, you will need to replace the fuse promptly.

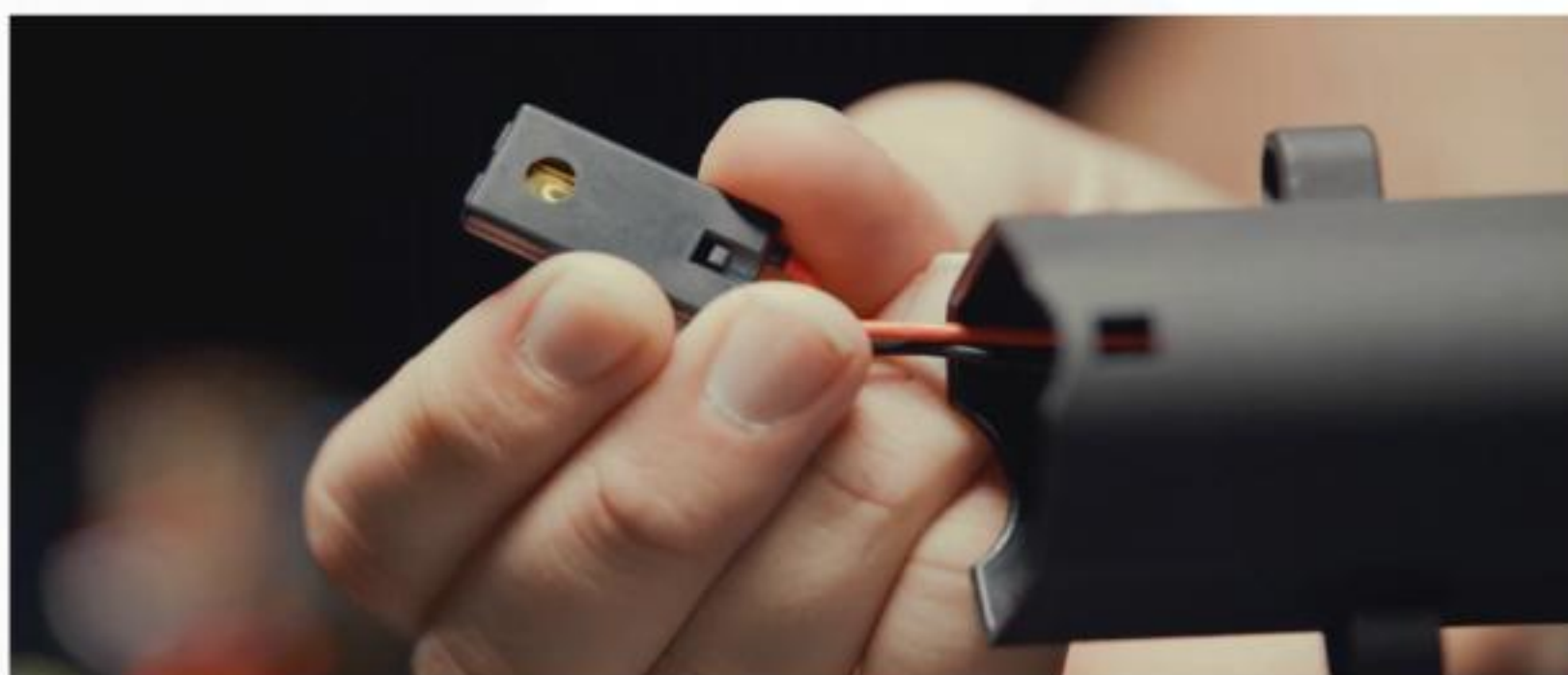

Connect your battery's Deans connector to the gun wiring. If the plugs do not smoothly click together, you may need to adjust the connector's orientation to ensure proper terminal connection. Forcing the plugs together can damage the internal terminals and cause damage to wiring preventing the gun from securing to the power source. Insert the battery into the stock housing and neatly tuck in the remaining wiring. Try to avoid bending the wiring excessively as this can greatly affect performance and may cause damage to the wiring. Replace the battery cover plate and reinstall the butt stock assembly.

2 - LOADING BB'S

To load bb's use a speed loader to insert bb's through the magazines feed lip. Once you can no longer easily insert bb's stop as the magazine is full. Loading beyond this point can cause damage to you magazine, speed loader, or both. To load bb's use a speed loader to insert bb's through the magazines feed lip. Once you can no longer easily insert bb's stop as the magazine is full. Loading beyond this point can cause damage to you magazine, speed loader, or both.

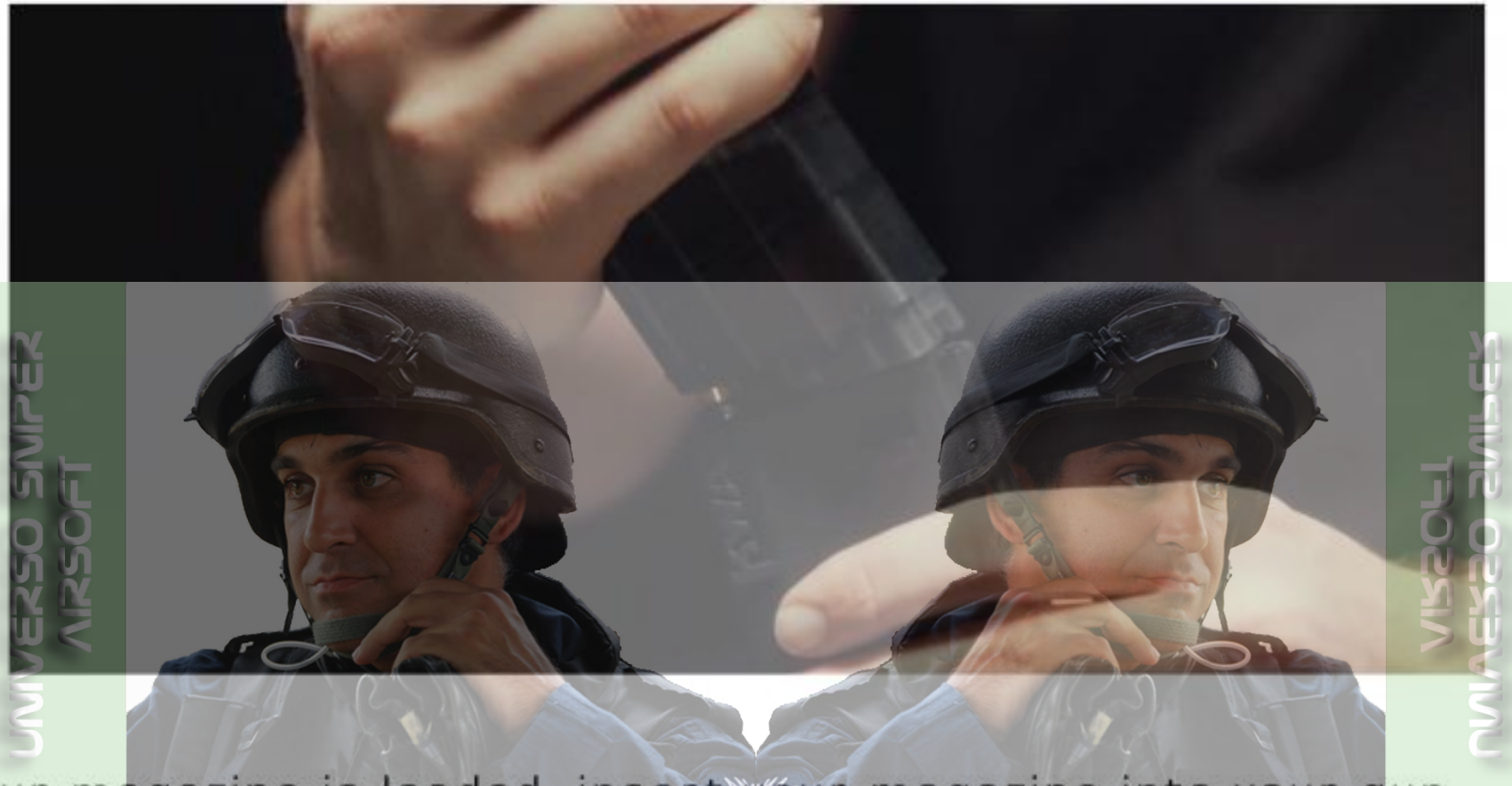

Now that your magazine is loaded, insert your magazine into your gun - you are now ready to fire!



The selector which can be found on either side of the gun had 3 modes, safe, semi, and full auto. On safe, an internal mechanism will prevent the gun from firing. On semi, only one bb's will be shot out per trigger pull. On full auto, bb's will continue to be shot until the trigger is released. Once done firing always put the gun on safe.

3 - ADJUSTING FPS

To adjust your front and rear PTS flip up sights simply use the adjustment levers located on the front sight and on the side of the rear one.

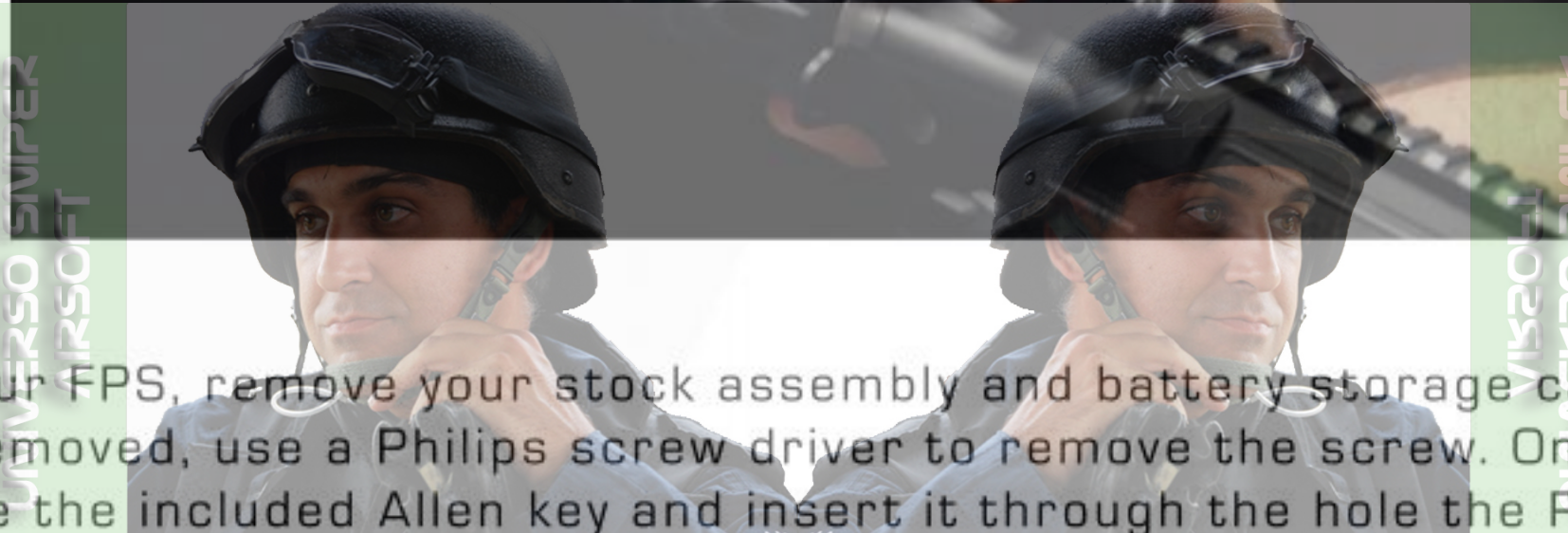
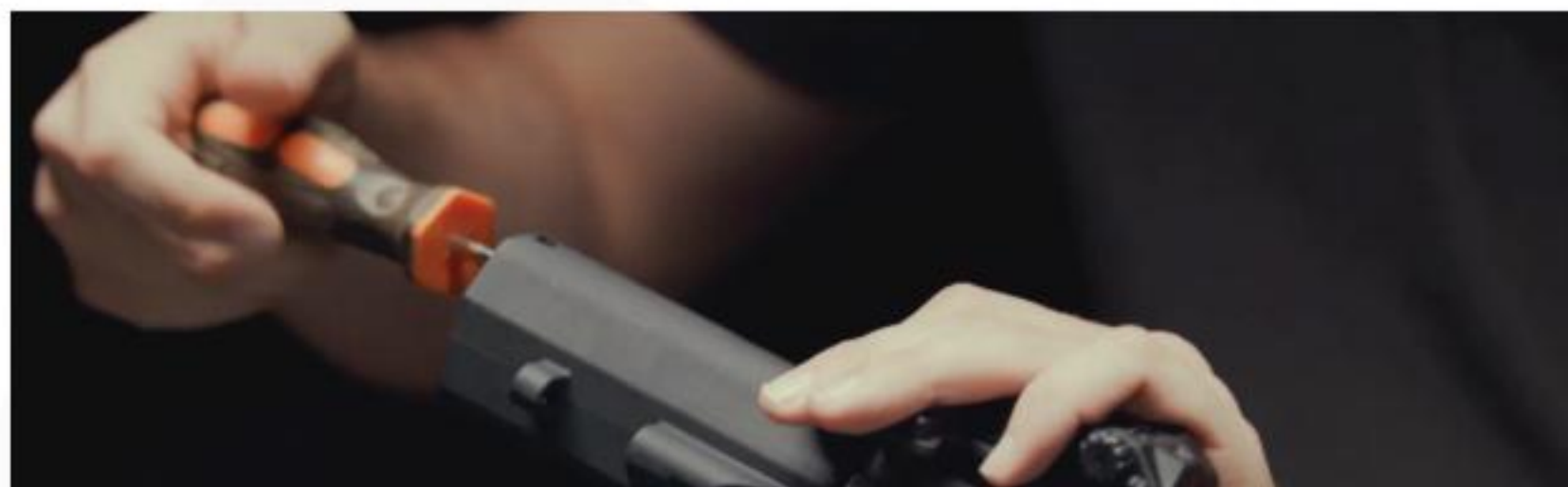

To adjust your FPS, remove your stock assembly and battery storage cap. Once these are removed, use a Philips screw driver to remove the screw. Once this is removed use the included Allen key and insert it through the hole the Philips screw came out of and twist for more or less FPS.

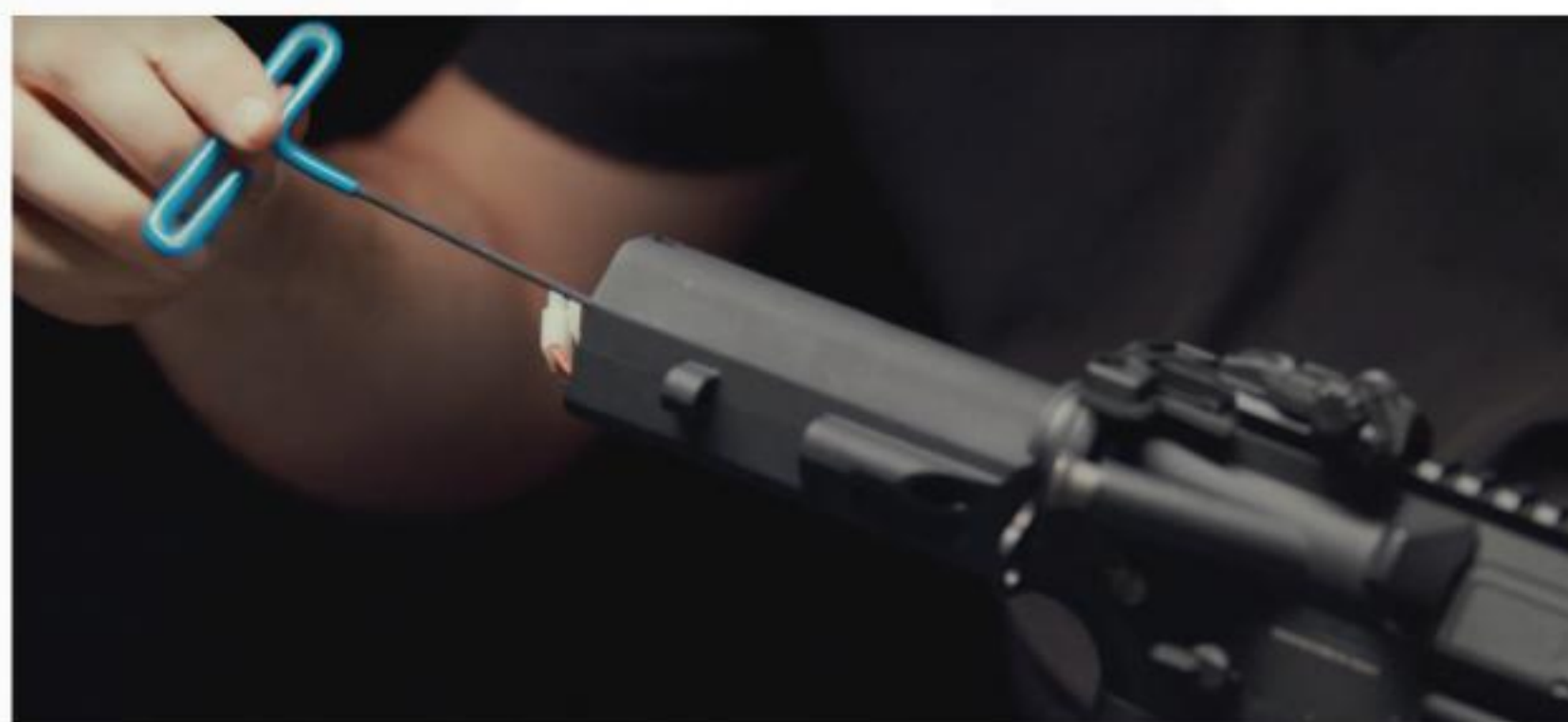

Twisting to the left results in less FPS, and twisting right results in more FPS. Once you have reached your desired FPS, reverse the process.

3 - ADJUSTING FPS AND SIGHTS - B

PTS Enhanced Polymer Back-Up Iron Sights

The Ronin Tactical Series AEGs use the PTS Enhanced Polymer Back-Up Iron Sights, which are made from ultra-durable DuPont Zytel High Performance Reinforced Polymer. The sights feature a low-profile, snag-free design that allows for sight adjustment without the use of any tools.

Front Sight:

To adjust the elevation setting on the front sight, simply rotate the polymer wheel to either raise or lower the sight post. Do not rotate the wheel too far, or the post may fall out.

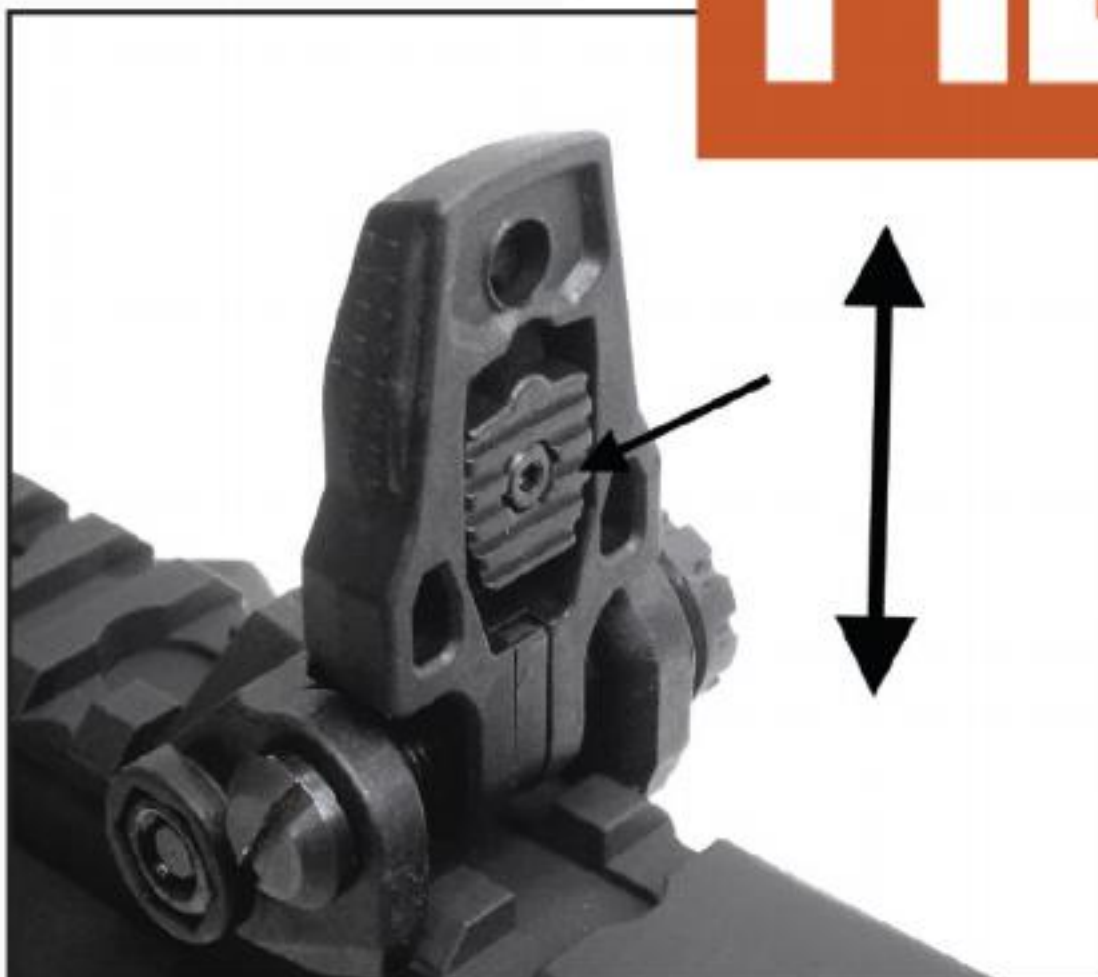
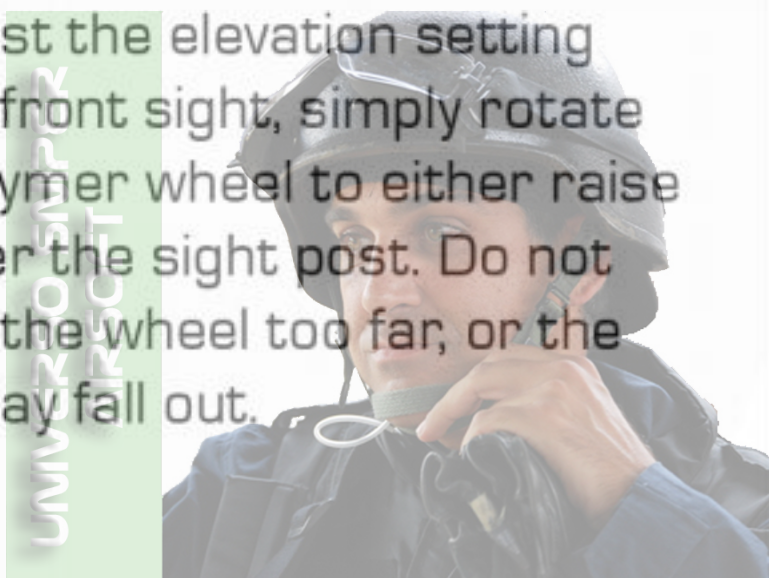

Rear Sight:

The rear sight features both large and small apertures and can be adjusted by shifting the center plate up or down. Windage is also adjustable by rotating the knob located on the right side of the sight.

4 - HOP-UP ADJUSTMENT

To adjust your hop up first pull you're charging handle to expose your hop up unit. Now engage your bolt catch to keep the dust cover open. Now test fire your gun in a safe direction and observe your flight path.



If your bb's are dropping apply more hop by adjusting your wheel up. If your bb's go straight up, apply less hop by adjusting the wheel down.



Once you have a flat trajectory you can stop adjusting and hit the bolt catch to release your mock bolt plate.

5 - DISASSEMBLING THE GUN

To disassemble your AEG for maintenance, remove the magazine and battery before continuing. Next, push the receiver front take down pin ensuring it is not blocking the upper receiver. Close the dust cover, then pull the charging handle to the rear while applying forward pressure to slide the upper receiver off. While removing the upper receiver, pay careful attention to the mock bolt plate ensuring it does wiggle free.



Once the upper is free from the lower receiver, slowly remove the inner barrel, inner barrel spring, and hop up unit. To clean your inner barrel, turn the hop up all the way up and use a cleaning rod with a barrel cleaning patch to clean your bore. After several passes with the cleaning rod and cloth/patch, the inner barrel should be free of any residue or dirt. Repeat this process until completely clean.



Reinstall the inner barrel back into the upper receiver and outer barrel. When sliding the upper receiver back onto the lower receiver, pay close attention to the mock bolt plate as it may catch the upper receiver and bend out of place. The bolt catch may also prevent the upper from sliding onto the lower easily, press the bottom portion of the bolt catch out of the way to ensure the upper slides on properly.

6 - TROUBLESHOOTING

If your gun is not shooting, first check to make sure your gun is off safe and in either semi or full auto. If it is in a firing position check your battery to make sure it has a secure connection. Inspect both connectors to make sure the wires are completely seated within the plug and that there is no damage to either unit. Additionally you can also try using another battery to confirm.



IMAGE IS A RONIN T6
MOD.3 COMES WITH DEANS

If this does not solve the issue, you may also want to inspect the wires farther down in the stock to ensure they have a complete connection as well.

If issues still persist, contact KWA support for further instructions and RMA repair.

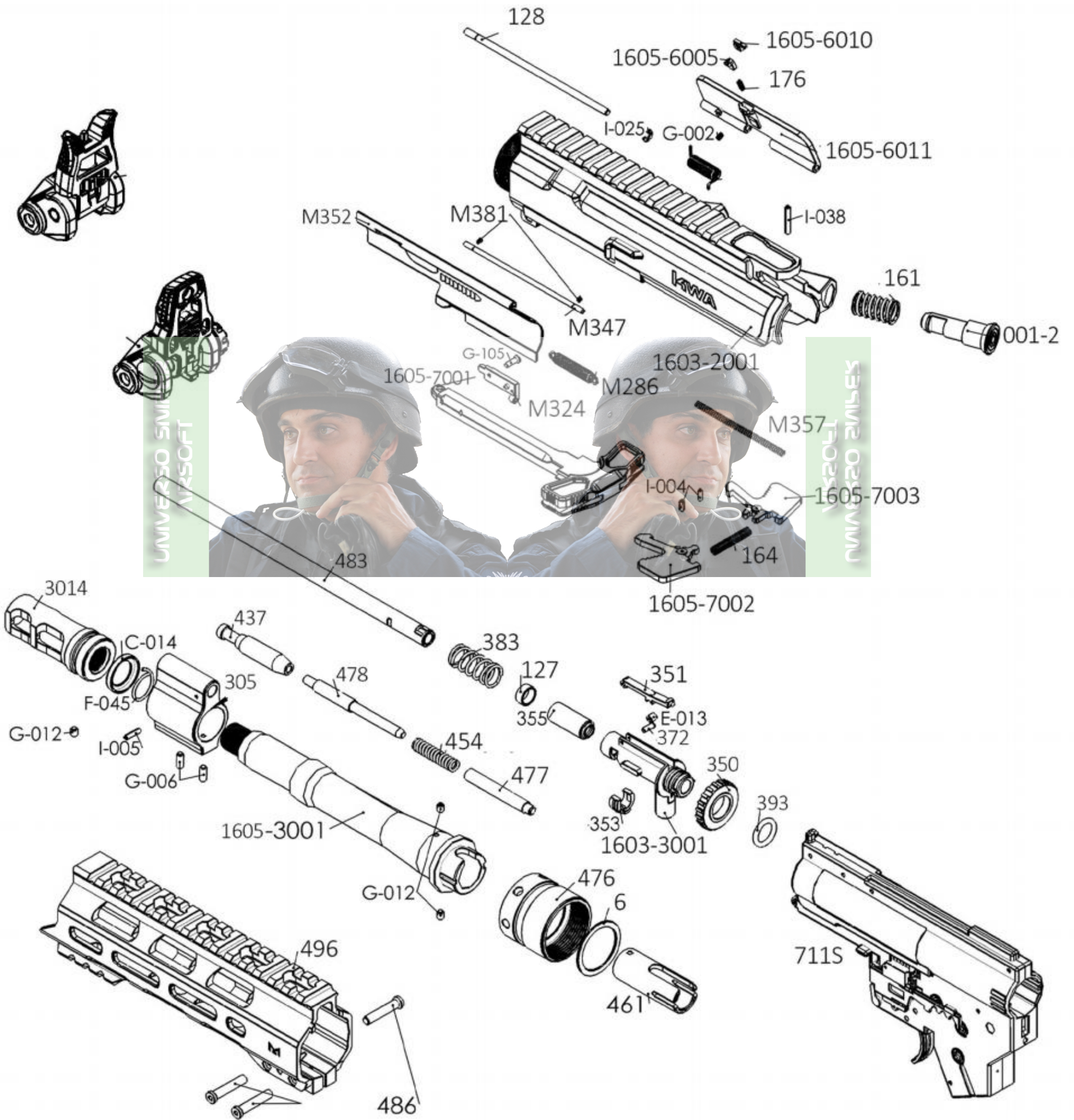

IMAGE IS A RONIN T6
MOD.3 COMES WITH DEANS

If your motor or battery is excessively hot after use, you may have a pinched wire and it is recommended to contact KWA customer support for additional assistance and RMA. If your guns hop up seems to be ineffective, please note that our guns to have a break in period of around 1000 rounds. If your hop up is still ineffective after this period contact KWA support for additional assistance.

KWA PERFORMANCE INDUSTRIES

QRF MOD.3 OPERATION MANUAL



KWA PERFORMANCE INDUSTRIES
QRF MOD.3 OPERATION MANUAL

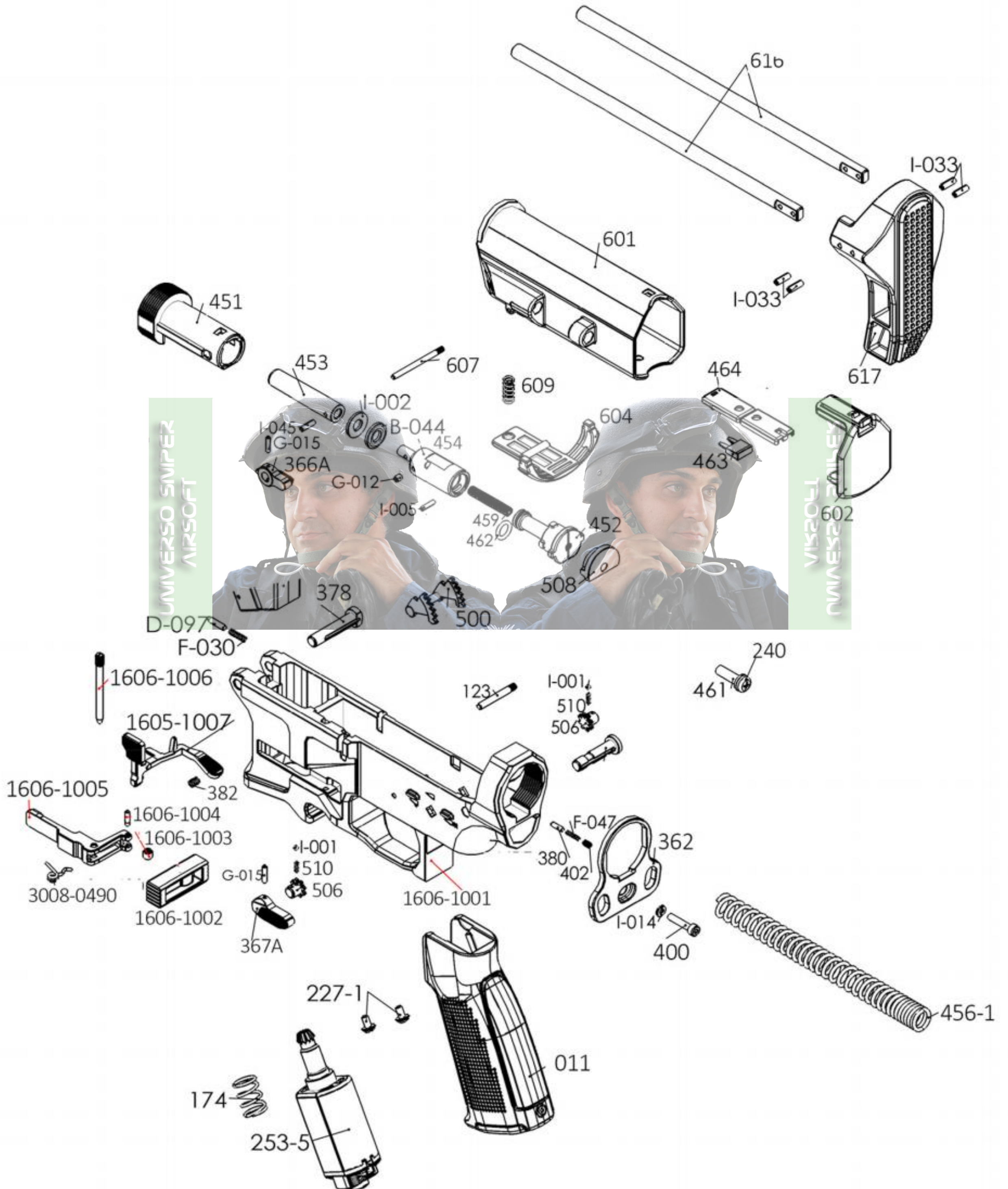

KWA PERFORMANCE INDUSTRIES
QRF MOD.3 OPERATION MANUAL

