

# KWA<sup>®</sup>

## OPERATOR'S MANUAL

UNIVERSO SNIPER  
AIRSOFT



**HK**  
HECKLER & KOCH

**MK23 USSOCOM**

## TABLE OF CONTENTS

Use of this manual .....	2
Safety Guidelines .....	2-3
Warranty and Service .....	4-5
Specifications .....	6
Contents .....	7
Functions and Features .....	7
Charging Gas .....	8
BB Loading .....	9
Loading Magazine .....	10
Fire Safety .....	10
Charging .....	10
Decocking .....	11
Shooting .....	11
Open Slide .....	12
After Shooting .....	12
Hop-Up System .....	13
Hop-Up Adjustment Point .....	14
Disassembly .....	15
Assembly .....	16
Troubleshooting .....	17
General Maintenance .....	18
Operating Under Unusual Conditions .....	18
Diagrams and Parts Lists .....	19-22

## USE OF THIS MANUAL

Before operating the Airsoft gun, read this manual in its entirety. Important safety topics and tips are discussed throughout all of the chapters. It's important that the operator know the principles of gun handling safety and operation prior to firing the Airsoft gun.

## SAFETY GUIDELINES



**WARNING! Failure to follow safety guidelines may result in serious injury.**

### Safety Distance

The effective shooting range is approximately 75 feet. BBs fired from this Airsoft gun may travel further than intended. Make certain that you have an adequate backstop.

### Eye Protection

Eye protection should be worn at all times when both shooting and maintaining your Airsoft gun. Protect your eyes from silicone spray and BBs under spring pressure while performing maintenance on your Airsoft gun.

### Assume Every Gun is Always Loaded

Until you are certain the chamber is empty, treat every gun as if it were loaded. Do not assume the chamber is empty based on your memory or someone else's words. Always remove the magazine and visually check to confirm the chamber is empty.

### Beware of Barrel Obstructions

Ensure the Airsoft gun barrel is free of obstructions before you fire the gun. Even the smallest obstruction such as dirt, dust or a stuck cleaning patch can cause a jam, misfire or malfunction.

### Muzzle Control

Always keep the muzzle of the gun pointed in a safe direction. Never point the muzzle at a person or object that you do not intend to shoot.

### Keep Your Safety On

Keep the gun's safety on until your sights are aligned on your target and you are ready to fire.

### Keep Your Finger Off The Trigger

Keep your finger off the trigger and out of the trigger guard until your sights are aligned on your target and you are ready to fire.



**WARNING! Airsoft BBs can be a choking hazard. Keep them away from children.**

## SAFETY GUIDELINES

### Identify Your Target and Backstop

Before you pull the trigger, make certain of your target and what is beyond it. The Airsoft gun should never be fired at surfaces such as rocks, glass, water, or other hard surfaces where BBs are likely to ricochet in unpredictable directions.



**WARNING! Adult supervision is required for any person under the age of 18.**

### Failure To Fire

If the Airsoft gun fails to fire, misfires, or malfunctions, do not look into the gun barrel. BBs can become lodged into the chamber, and serious eye injury may occur.

### Maintain Your Gun Properly

Performing proper maintenance, as outlined in this manual, ensures that your Airsoft gun will be safe to shoot and will perform to its designed specifications for many years. Alterations, modifications or adjustments may damage your Airsoft gun, make it unsafe to shoot, and will void all warranty claims.

### Store Your Gun Safely

Always store the Airsoft gun in a safe place, and out of the reach of children. Always transport the Airsoft gun in a carrying case. Never display the Airsoft gun in a public place. Keep the safety engaged, and remove the magazine before storing the Airsoft gun.

**NOTE:** IT IS YOUR RESPONSIBILITY TO TAKE EVERY REASONABLE PRECAUTION TO ENSURE THE SAFE STORAGE AND TRANSPORTATION OF YOUR AIRSOFT GUN.

### Orange Tip

The orange tip on Airsoft guns helps Law Enforcement distinguish between the replica guns from their real firearm counterparts. Altering the coloration or markings required by state or Federal law so as to make the product look more like a firearm is dangerous and may be a crime. Operator assumes all risks and responsibility when doing so.

### Hazards of Being Mistaken for a Real Firearm

Airsoft guns have been mistaken by Police and Law Enforcement as real firearms. A confrontation with law enforcement while carrying an Airsoft gun can result in serious injury or even death. It is strongly advised to operate the Airsoft gun at a safe and legal location. In the event that you are approached by Law Enforcement personnel, you must comply with their instructions immediately to avoid an incident.

### Alcohol, Medications and Drugs

Do not handle or operate your Airsoft gun while under the influence of alcohol, medication or drugs.

### Your Responsibility

Your Airsoft gun is well-engineered and manufactured to the highest standards. It was carefully inspected before it was packaged and shipped from our factory. Its safe use depends on you alone. You are the ultimate safety device. Like many other devices, your Airsoft gun is safe unless handled in an irresponsible or uneducated manner.

## WARRANTY AND SERVICE

KWA Performance Industries, Inc. is committed to serve our customers with the finest quality products, the highest level of service, and customer satisfaction. Because of this, we offer a 45-day warranty on all KWA products we import and distribute.

### What is Covered

Except as specified below, this warranty covers all defects in material and workmanship in KWA products occurring during the above warranty periods. The following are not covered by the warranty: (1) Any product which is not imported and distributed in the U.S.A. by KWA PERFORMANCE INDUSTRIES, INC. (2) Any products not purchased in the U.S.A. from an KWA AUTHORIZED RESELLER (Note: KWA AUTHORIZED RESELLER can be identified by KWA AUTHORIZED RESELLER sticker displayed in the store. If you are uncertain as to whether a dealer is a KWA AUTHORIZED RESELLER, please contact KWA PERFORMANCE INDUSTRIES, INC. as listed above). (3) Damaged deterioration or malfunction resulting from: a) Accident, act of nature, abuse, misuse, neglect, unauthorized product repair, opening of or modification or failure to follow instructions supplied with the product. b) Repair or attempted repair by anyone not authorized by KWA PERFORMANCE INDUSTRIES, INC. c) Removal of the orange safety tip. (4) Use of the product outside the U.S.A. (5) Damaged batteries or improper use of bullets (BBs), or non approved propellants (i.e. Propane, Red Gas, 134a...etc.) (6) Use in industrial, commercial, and/or professional applications.

### What KWA Will Pay For

If during the applicable warranty period from the date of the original purchase your KWA product is found to be defective by KWA Performance Industries, Inc., KWA Performance Industries, Inc. will repair, or at its option, replace with new, used, or equivalent model, the defective product without charge for parts or labor.

### How To Obtain Warranty Service

If your product needs service, it may be taken or shipped to KWA Performance Industries, Inc. The following procedures apply whenever your unit must be transported for warranty service:

- You must go to the Help Desk at [www.kwausa.com/support](http://www.kwausa.com/support) to obtain an RMA number. THE RMA NUMBER MUST BE CLEARLY MARKED ON THE OUTSIDE OF THE PACKAGE. PACKAGES WITHOUT AN RMA NUMBER CLEARLY MARKED WILL BE REFUSED AND RETURNED TO THE SENDER.
- You are responsible for transporting your unit or arranging for its transportation.
- If shipment of your unit is required; you must pay the initial shipping fee, but we will pay the return shipping charge if the repairs are covered by the warranty.
- WHEN RETURNING YOUR UNIT FOR WARRANTY SERVICE, A COPY OF THE ORIGINAL SALES RECEIPT MUST BE ATTACHED.
- You must include the following: RMA number, your name, address, daytime telephone number, model and serial number (if applicable) of the product and a description of the problem.



**This Warranty is Only Valid in the United States**

If your product does not require service, but you have questions regarding its operation, please contact our Technical Services Department as listed below.

THIS WARRANTY IS EXPRESSLY MADE IN LIEU OF ALL OTHER WARRANTIES, EXPRESSED OR IMPLIED, INCLUDING WITHOUT LIMITATION, WARRANTIES OF MERCHANTABILITY AND FITNESS FOR A PARTICULAR PURPOSE.

OUR LIABILITY IS LIMITED TO THE REPAIR OR REPLACEMENT, AT OUR OPTION, OF ANY DEFECTIVE PRODUCT AND SHALL IN NO EVENT INCLUDE INCIDENTAL OR CONSEQUENTIAL COMMERCIAL OR PROPERTY DAMAGES OF ANY KIND. WE ARE NOT RESPONSIBLE FOR PRODUCTS LOST, STOLEN AND/OR DAMAGED DURING SHIPPING.

SOME STATES DO NOT ALLOW LIMITATIONS ON HOW LONG AND IMPLIED WARRANTY LASTS AND/OR DO NOT ALLOW THE EXCLUSION OF INCIDENTAL OR CONSEQUENTIAL DAMAGES, THE ABOVE LIMITATIONS AND EXCLUSIONS MAY NOT APPLY TO YOU.

This warranty gives you specific legal rights, but you may also have other rights which vary from state to state. This Warranty may not be altered other than in writing signed by an officer of KWA Performance Industries, Inc.

KWA Performance Industries, Inc.  
18571 E. Gale Ave.  
City of Industry, CA 91748-1339

626-581-1777  
[www.kwausa.com](http://www.kwausa.com)

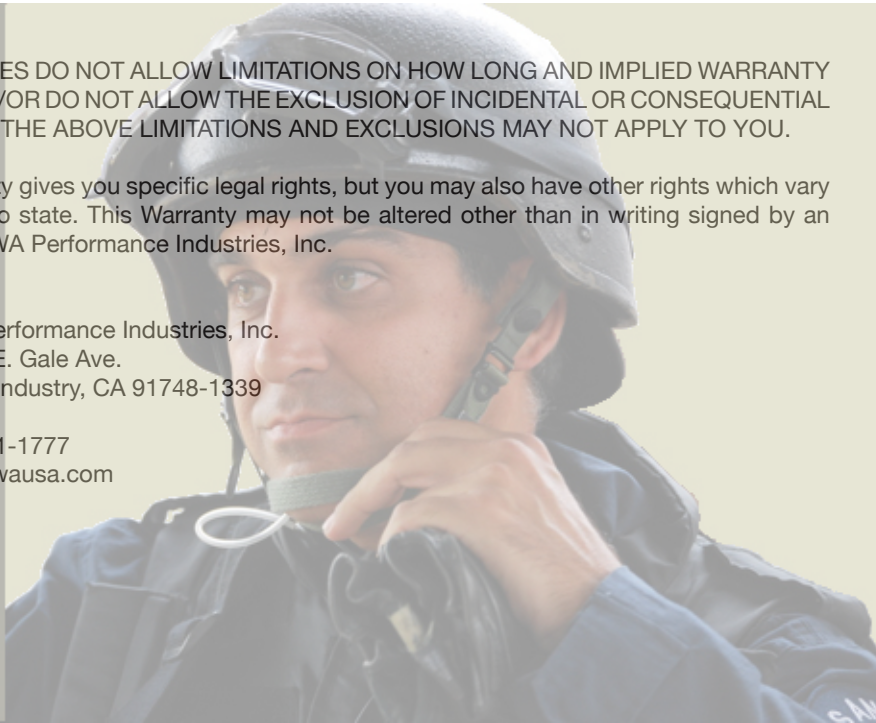

UNIVERSO SNIPER  
AUSSET  
V

## SPECIFICATIONS

- Overall Length = 25 cm [9.84"]
- Overall Height = 15 cm [5.91"]
- Inner Barrel Length = 130 mm
- Inner Barrel Diameter = 6.05 mm
- Weight = 1.16 kg [2.56 lbs]
- Barrel Thread = 16 mm CW
- Caliber = 6 mm
- Magazine Capacity = 25 rounds
- Velocity = 110-116 MPS [360-380 FPS]
- Energy Output with 0.20g BB = 1.2 Joules
- Gas System = NS2
- Action = Double and Single
- Propellant = Green Gas

### Special Features:

- Safety / decocking lever
- Ambidextrous safety lever
- Ambidextrous magazine release
- Accessory rail
- Threaded barrel
- 3-dot combat sight
- Adjustable Hop-Up
- Realistic construction and field stripping

\*Individual test results may vary depending on brand of BBs, type of gas, and chronograph used.



## CONTENTS

### Product Package Contents

- 1 HK MK23 USSOCOM Airsoft gun
- 1 Bottle of Silicone Oil
- 1 Magazine
- 1 Sample bag of Airsoft BBs
- 1 Hop-Up Adjustment Tool
- 1 Operator's Manual

## FUNCTIONS AND FEATURES

### HK MK23 USSOCOM with NS2 gas system

The HK MK23 USSOCOM Airsoft guns are equipped with the new KWA NS2 internal gas delivery system, which increases performance and improves the overall reliability of the gun.

The NS2 gas system is a KWA-patented design that uses an advanced, light-weight composite gas piston with a two-stage internal expansion chamber that delivers the gas more efficiently than that of its predecessors. The NS2 design also increases the weapon cycle rate and provides for a crisp, realistic blow-back action.

Other parts of the Airsoft gun, including the recoil springs, recoil spring guide assembly, hop-up chamber, and magazine follower, have been improved, along with a new magazine that is milled from a solid alloy steel billet. This new construction strengthens the magazine's structural integrity and increases pressure carrying capacity. The magazine feed-lip has also been reinforced.

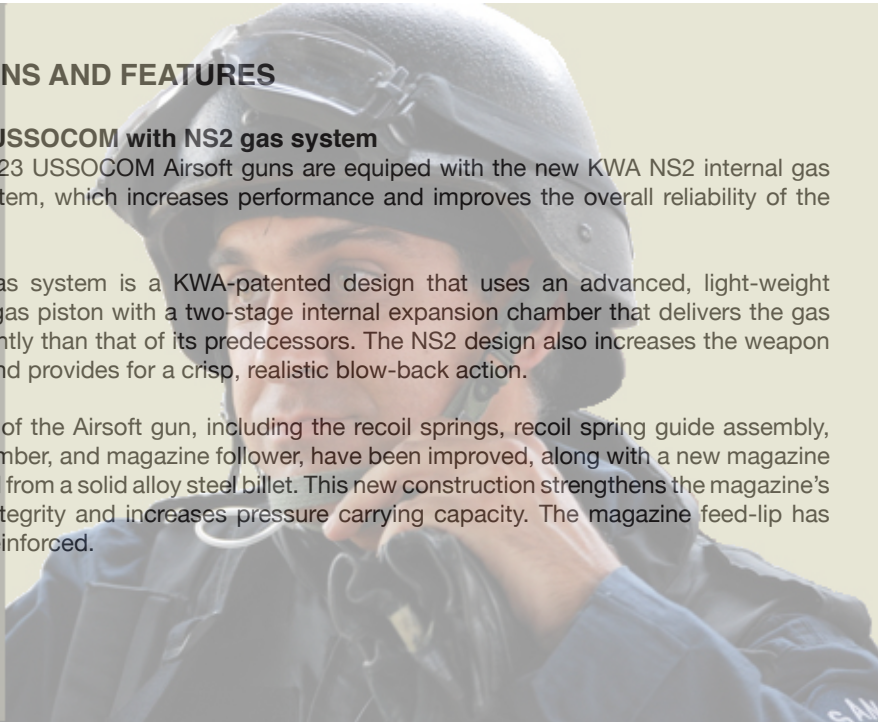

UNIVERSITY OF CALIFORNIA



## CHARGING GAS

1. Release the magazine by pressing the magazine release button.
2. Push the gas canister nozzle into the charging valve. Make sure the canister is in a vertical position when charging.
3. Charge the magazine for approximately 10-15 seconds.



**WARNING: Avoid dropping the magazine. Sudden impact with a hard surface may cause damage to the magazine.**

**Note:** It is normal to have minor leaking from the charging valve during charging due to high pressure built up inside the magazine. It is recommended to keep the gas release valve slightly oiled. Room temperature is the ideal temperature for shooting. You may experience a delayed action if the surrounding temperature drops below 68° F.

**Note:** Do not expose the magazine to direct sunlight or incinerate the magazine, as this may cause the magazine to burst. It is strongly recommended to empty the gas from the magazine after shooting. Be certain that the gas does not make contact with eyes or skin while being released, as any contact will cause cold burns.

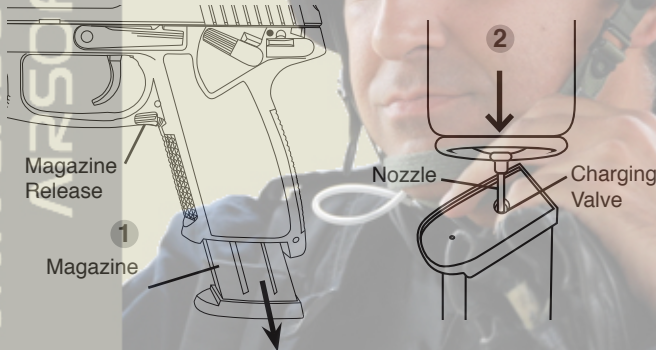

## DISCHARGING GAS

Hold the magazine at the bottom. Press the valve. Residual gas may now be discharged.

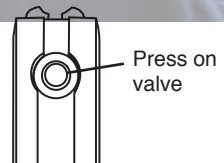

### Green Gas safety tips:

- Check the canister for any cracks or leaks before using.
- Do not expose the canister to temperature over 104° F.
- Do not leave the canister directly over fire.
- Do not heat the canister.
- Keep the canister away from direct sunlight.
- Do not leave the canister in any type of vehicle.

## LOADING BBs

1. Pull the magazine follower down until it locks.
2. Insert BBs into the magazine lip.
3. BBs should stack staggered for maximum round capacity: 48 rounds.
4. Make sure to have a 3mm clearance between BBs and the top lip of the magazine.
5. Push the magazine follower lock to release.



**WARNING:** Use only 6mm high grade BBs. Using low grade BBs will damage Airsoft gun.

**NOTE:** Use 0.25g or heavier BBs for better performance.



**WARNING:** Do not release the magazine follower when the magazine is empty. Doing so will damage the magazine and magazine follower.

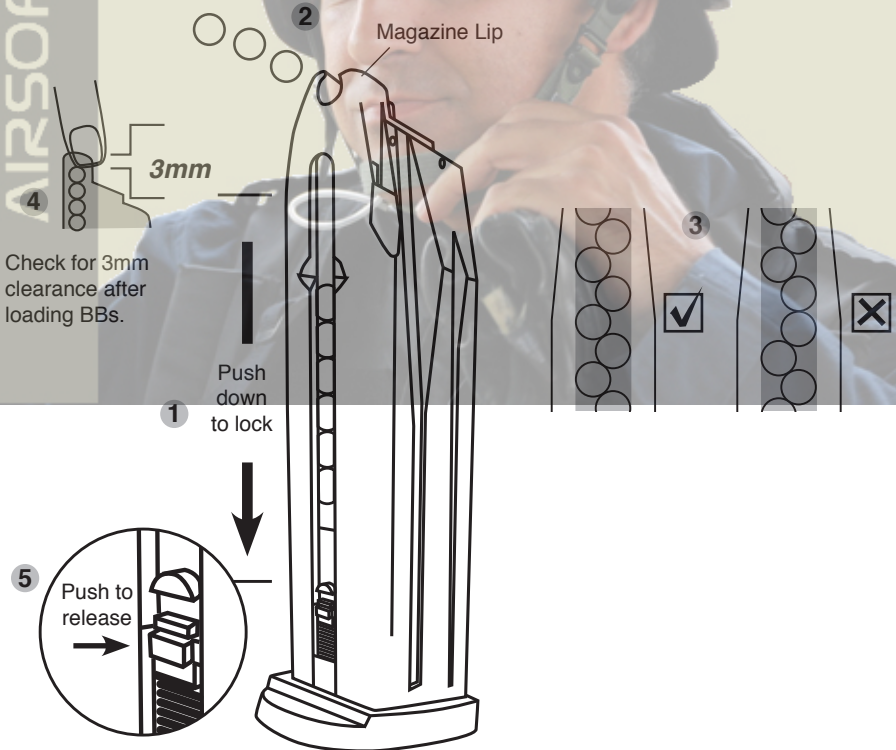

## LOADING MAGAZINE

1. Place the magazine back into the magazine well.
2. Push the magazine up until it clicks into a locked position.
3. Pull the magazine down to assure that it has been locked in place.

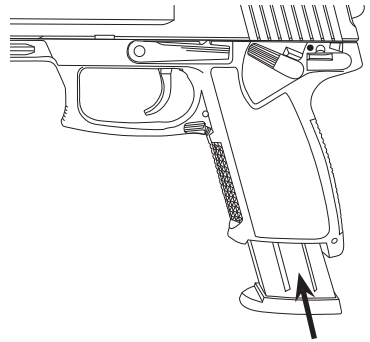

## FIRE SAFETY

To engage the Safety, push the safety lever upward. The gun is not ready to fire.  
(UP = ON = NOT READY TO FIRE)

To disengage the Safety, push the safety lever downward. The gun is ready to fire.  
(DOWN = OFF = READY TO FIRE)

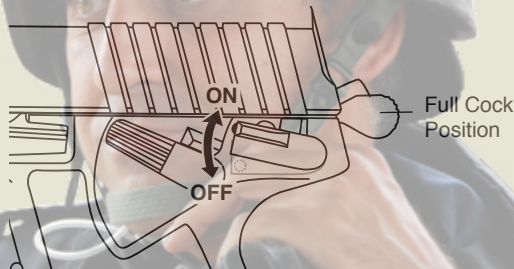

## CHARGING

Pull the slide to the rear-most position and release the slide. This will automatically load the BBs into the chamber. The hammer will be in a cocked position. Make sure not to skip this procedure. Skipping this step will cause a misfire on the first pull of the trigger. The slide will stay open when the last BB is fired.

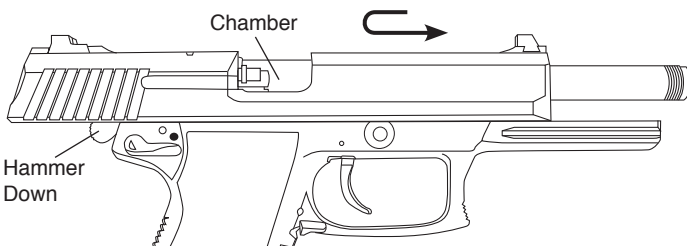

## DECOCKING

To decock hammer, push lever downward and hammer is safely decocked without firing.

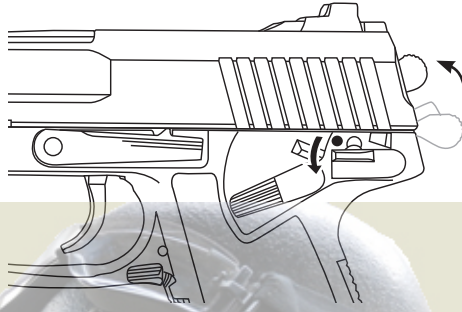

## SHOOTING

1. Release the safety and pull the trigger. The blow-back action will load the BBs automatically as the slide cycles back and forth.
2. Grasp the Airsoft gun firmly in your hand. To properly control the gun, grasp it with a two-hand hold with one hand wrapped around the other.



**WARNING:** Never shoot gun in a horizontal or upside-down position.

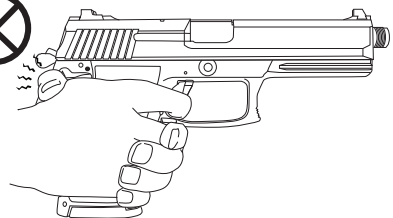
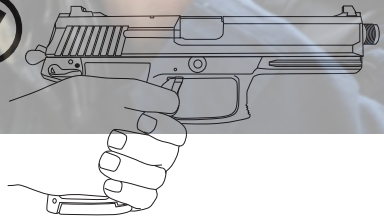
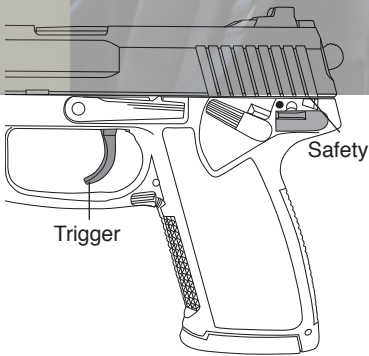

## OPEN SLIDE

The slide will remain open after the last BB has been fired and ejected. Remove the empty magazine and replace it with a loaded magazine, then release the slide stop. The first BB will be automatically loaded into the chamber.

**Note:** It is important to treat your gun as if it were loaded even when the slide is open.

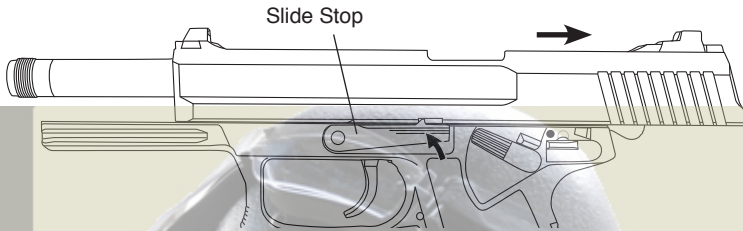

## AFTER SHOOTING

After you are finished shooting, remove the magazine and visually examine the open chamber to check for clearance. Make sure both the magazine and the chamber are clear without BBs, **release slide then engage the safety lever.**

### CHECK

Make sure  
chamber is clear

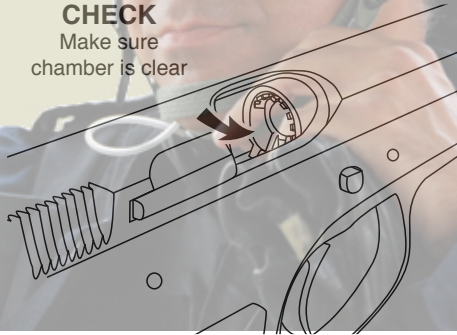



## HOP-UP SYSTEM

The Hop-Up device is one of KWA's standard features, giving Airsoft BBs greater stability, further travel and increased accuracy. Airsoft BBs are light-weight and can be affected by wind when fired. With the Hop-Up system, the trajectory of the Airsoft BBs can be adjusted according to the shooting environment or surroundings.







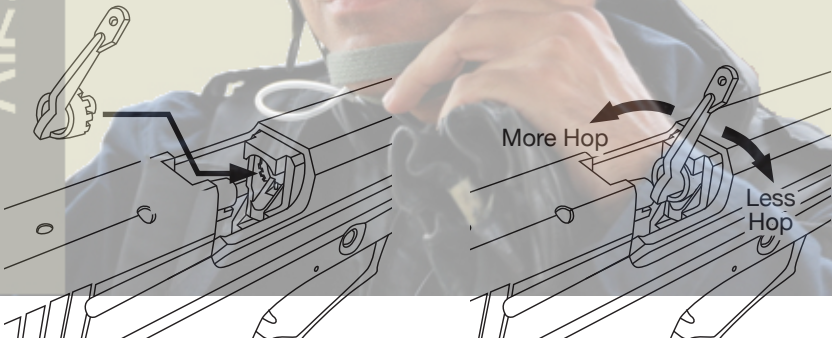

### HOP-UP ADJUSTMENT

To adjust the Hop-Up, make sure the magazine is loaded and that you have at least 65 feet of clearance for a test fire before making any adjustments.

1. Test fire the gun for 10 to 20 rounds and observe the BB's traveling pattern.
2. Remove the magazine.
3. Open the slide and place adjusting tool into the slotted chamber ring. Turn the adjusting ring a 1/4-inch at a time.
4. If the BBs are dropping too quickly, move the adjusting ring to the left or counter-clockwise to give the BB more hop. If the BBs are dropping too slowly, move the adjusting ring to the right or clock-wise.
5. Test fire and adjust as needed.



## HOP-UP ADJUSTMENT POINT

BB TRAJECTORY PATTERN		ADJUSTMENTS
	BB DROPS FREELY	 TURN KNOB TO LEFT
	BB TRAVELS AT SHORT TRAJECTORY PATH	 TURN KNOB SLIGHTLY TO LEFT
	BB TRAVELS DISTANCE AT FLAT TRAJECTORY PATH	NO ADJUSTMENT MADE
	BB TRAVELS FLAT IN SHORT DISTANCE, THEN GOES UP IN CURVE AND DROPS FREELY	 TURN KNOB SLIGHTLY TO RIGHT
	BB TRAVELS AT UNSTABLE SPEED AND IRREGULAR PATH	 TURN KNOB TO RIGHT

UNIVERSO SNIPER  
AIRSOFT



## DISASSEMBLY

It is not recommended to disassemble the gun unless you have BBs jammed inside the barrel or for maintenance purpose only.

1. Remove the magazine by depressing the magazine releases on either side of the Airsoft gun.
2. Check and clear the chamber of BBs.
3. Pull back the slide until a small cut out slot on the slide aligns with the front of the slide stop.
4. While holding the slide in position, remove the slide stop by pushing on the release pin from the right side of the frame and pull off the slide stop from the left side of the frame.
5. Glide the slide forward, away from the frame.
6. Slide the barrel out from the bottom of the slide.
7. Remove the guide rod and spring.

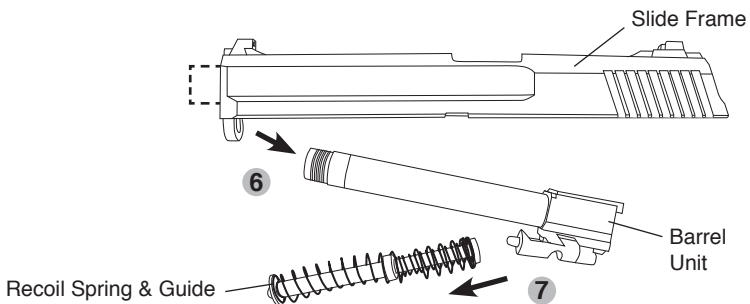
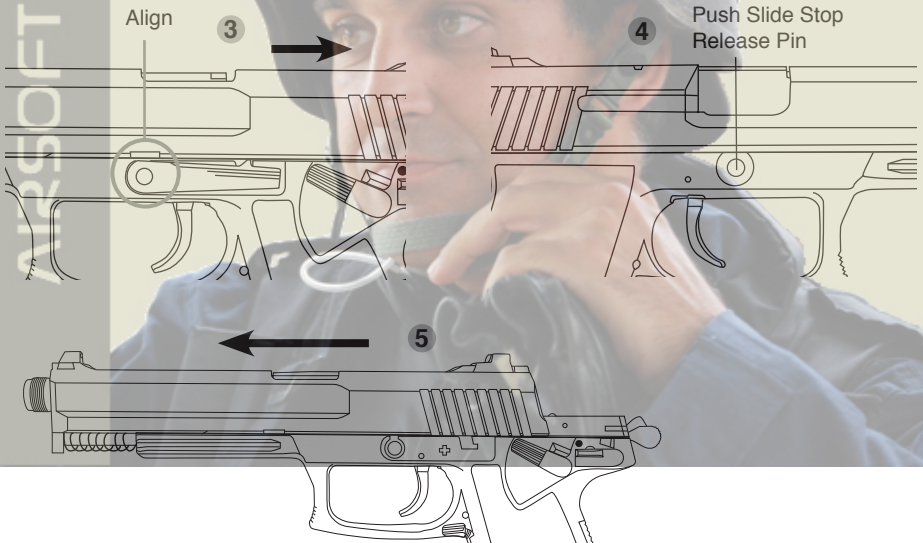

## ASSEMBLY

1. Place the barrel into the slide from the bottom of the slide.
2. Install the recoil spring and guide rod into position.
3. Put the slide onto the frame rails. Glide it toward the rear of the Airsoft gun until the small cut-out slot on slide aligns with the cut-out slot on the frame.
4. While holding the slide in position, insert the slide-stop.
5. Pull the slide to the rear-most position and then release.
6. Install the magazine.

**NOTE:** After assembly is completed, cycle the slide back and forth to insure proper assembly.



**BASIC TROUBLESHOOTING GUIDE FOR PISTOL**

<b>SYMPTOMS</b>	<b>POSSIBLE CAUSE</b>	<b>SOLUTIONS</b>
Slide jams / Will not complete cycle	Dry internal	Add silicone to cylinder / main seal / rails
Double feeds BBs into chamber / BB's roll out of barrel	Hop-up adjustment too tight	Release hop-up or replace bucking
BBs will not release from magazine / bent mag lip/ check bb condition	Bent magazine lip	Replace magazine lip
Leaking release valve & charging valve	Dry O-ring	Add silicone oil to valves
Slide stop engages while shooting BBs	Weak slide stop spring	Adjust tension
Magazine base plate will not lock	Broken base plate lock	Replace base plate lock
Magazine base leaking air	Worn out base seal	Replace magazine base seal
Cylinder will not load BBs into chamber	Broken cylinder tap	Replace cylinder
Trigger will not reset	Worn out trigger spring / trigger bar spring	Replace trigger spring / trigger bar spring

UNIVERSO SNIPER  
AIRSOFT





## GENERAL MAINTENANCE FOR KWA GAS BLOW BACK

Use only 100% Silicone oil recommended by, and available at, the Airsoft dealer where you purchased your KWA products. Any other type of lubricant may damage the products.

Lightly lubricate recoil spring, cylinder and moving parts with few drops of oil.

Lubricating seals and the o-rings are essential. Unload BBs from magazine and make sure the magazine is free of gas before you lubricate charging valve and release valve of the magazine.

Green gas is liquid propellant which tends to dry out the seals and o-rings. With lubricating silicone oil, it will extend the life of the seals and o-rings and prevent gas leaks.

## OPERATING UNDER UNUSUAL CONDITIONS

Unusual conditions are defined as any condition requiring special maintenance. Perform maintenance outlined for the climate similar to your operational area.

### **Extreme Cold:**

Operating an Airsoft gas gun in extremely cold temperatures is not recommended. Cold temperature will cause the Hop-up Bucking to harden, reducing its effectiveness. Gas will not expand properly in cold temperatures, so cycling rate and power will both be dramatically reduced.

### **Extreme Heat:**

Operating an Airsoft gas gun in extremely hot temperatures is not recommended. Leaving the gun in direct sun light for long periods of time or operating in extremely hot areas will cause the gas to over-expand, damaging the internal workings of the gun. The increase in internal pressure from the expanding gas can also damage the seals and cause leaks in the magazine.

### **Dust or Sand:**

Dust or sand can get into a gas gun and cause malfunctions and/or excessive wear. Keep the gun covered whenever possible. Use lubricant sparingly, as lube naturally attracts dirt and other particles. After use in a dusty area, always field strip the gun (refer to Disassembly Section) and clean any areas you can reach with a soft, lint-free cloth.

HK MK23 PARTS DIAGRAM



UNIVERSO SNIPER  
AIRSOFT



PARTS LIST

Parts #	Description
199-0104-1	SLIDE
199-0104-2	MAIN FRAME
199-0104-3	OUTER BARREL
199-0104-4	CYLINDER
199-0104-5	MAIN SPRING HOUSING
199-0104-6	NUMBER PLATE COVER
199-0104-7	SIGHT INSERTS X 3
199-0104-8	HOP-UP CYLINDER CLAMP
199-0104-9	HOP-UP CYLINDER
199-0104-10	JET NOZZLE
199-0104-12	INNER FRAME
199-0104-13	FRONT SIGHT
199-0104-14	REAR SIGHT
199-0104-15	EXTRACTOR
199-0104-16	HAMMER
199-0104-17	TRIGGER
199-0104-18	SLIDE STOP LEVER
199-0104-19	SAFETY LEVER (LEFT)
199-0104-20	SAFETY LEVER (RIGHT)
199-0104-21	MAGAZINE CATCH
199-0104-22	BREECH
199-0104-23	INNER BARREL BASE
199-0104-24	FEED RAMP
199-0104-25	SEAR
199-0104-26	IMPACT BLOCK
199-0104-27	IMPACT FRAME
199-0104-28	IMPACT LINK
199-0104-29	IMPACT BLOCK RESET
199-0104-30	DECOCKING LOCK OUT
199-0104-31	SEAR BLOCK
199-0104-32	DECOCKER
199-0104-33	DECOCKER SLEEVE
199-0104-34	RECOIL SPRING GUIDE LOCK
199-0104-35	INNER BARREL CLAMP
199-0104-37	MAIN SPRING HOUSING PIN

Parts #	Description
199-0104-38	REAR SIGHT SCREW
199-0104-39	TRIGGER PIN
199-0104-40	SEAR PIN
199-0104-41	TRIGGER BAR PIN
199-0104-42	INNER BARREL
199-0104-43	HAMMER PIN
199-0104-44	HAMMER SLEEVE
199-0104-45	RECOIL SPRING GUIDE B
199-0104-46	RECOIL SPRING WASHER "REAR"
199-0104-47	RECOIL SPRING WASHER "FRONT"
199-0104-48	RECOIL SPRING GUIDE LOCK PIN
199-0104-49	BUFFER SPRING RETAINER
199-0104-50	FIRING PIN
199-0104-51	MAIN SEAL BASE
199-0104-52	DECOCKING LEVER SHAFT
199-0104-53	IMPACT BLOCK PIN
199-0104-54	IMPACT BLOCK RESET SCREW
199-0104-55	IMPACT FRAME PIN
199-0104-56	IMPACT FRAME SLEEVE
199-0104-57	MAIN SEAL CAP
199-0104-58	CYLINDER PIN
199-0104-59	FEED LAMP PIN X2
199-0104-60	BREECH SCREW
199-0104-61	SAFETY LEVER SHAFT
199-0104-62	SAFETY LEVER SCREW
199-0104-65	RECOIL SPRING
199-0104-66	BUFFER SPRING
199-0104-67	MAIN SPRING
199-0104-68	MAGAZINE CATCH SPRING
199-0104-69	SAFETY LEVER SPRING
199-0104-70	SLIDE STOP LEVER SPRING
199-0104-71	EXTRACTOR SPRING

Parts #	Description
199-0104-72	SEAR SPRING
199-0104-73	HAMMER REBOUND SPRING
199-0104-74	TRIGGER BAR SPRING
199-0104-75	DECOCKER SPRING
199-0104-76	IMPACT BLOCK SPRING
199-0104-77	IMPACT BLOCK RESET SPRING
199-0104-78	IMPACT FRAME SPRING
199-0104-79	CYLINDER SPRINGS X 2
199-0104-80	FIRING PIN SPRING
199-0104-81	JET NOZZLE SPRING
199-0104-84	TRIGGER BAR
199-0104-85	HAMMER STRUT
199-0104-86	DISCONNECTOR
199-0104-87	SEAR ACTUATOR
199-0104-88	NUMBER PLATE
199-0104-89	DECOCKING LEVER
199-0104-94	MAIN SEAL
199-0104-95	HOP-UP BUCKING
199-0104-96	DECOCKER RETAINING RING
199-0104-97	OUTER BARREL O-RING
199-0104-98	FRONT SIGHT SCREW
199-0104-99	INNER FRAME SCREW
199-0104-100	INNER BARREL CLAMP SCREW
199-0104-101	MAIN SEAL CAP SCREW
199-0104-102	BUFFER SPRING
199-0104-103	MAGAZINE CATCH PIN
199-0104-104	BREECH SCREW
199-0104-105	SAFETY LEVER SET SCREW
199-0104-106	RECOIL SPRING WASHER RETAINER
199-0104-107	HOP-UP BALL
199-0104-108	SAFETY LEVER BALL
199-0104-109	DISCONNECTOR WASHER
199-0104-110	IMPACT HAMMER PIN E-CLIP

# HK MK23 MAGAZINE DIAGRAM AND PARTS LIST

UNIVERSO SNIPER AIRSOFT

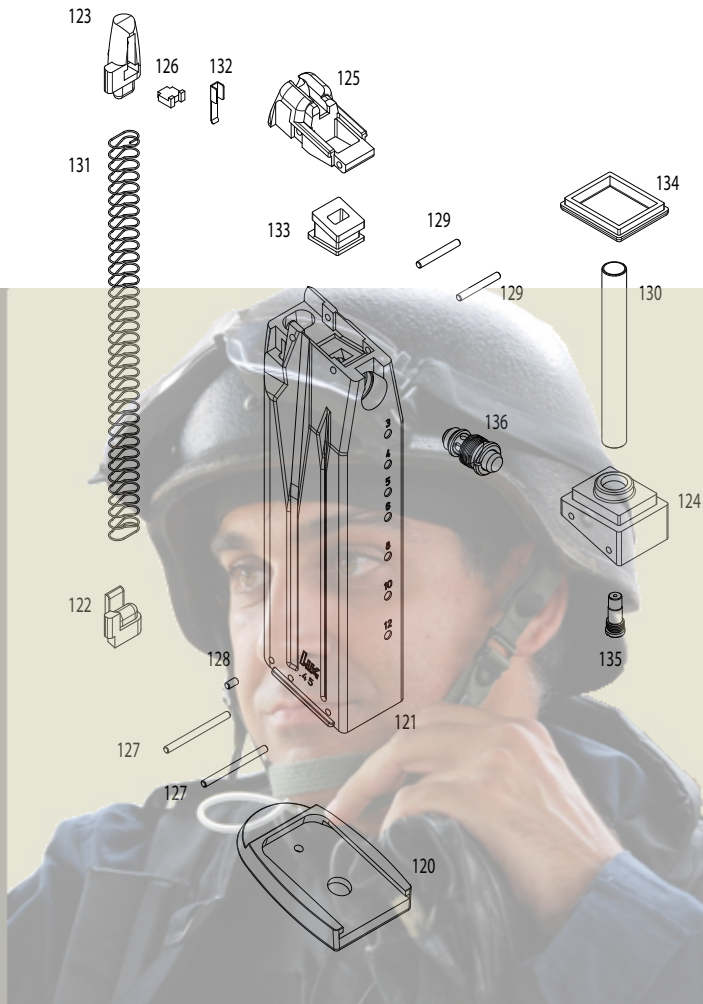

Parts #	Description
199-0104-120	MAGAZINE BASE PLATE
199-0104-121	MAGAZINE BODY
199-0104-122	MAGAZINE BASE LOCK
199-0104-123	MAGAZINE FOLLOWER
199-0104-124	MAGAZINE BASE
199-0104-125	MAGAZINE LIP
199-0104-126	MAGAZINE FOLLOWER LOCK
199-0104-127	MAGAZINE INNER BASE PINS X 2
199-0104-128	MAGAZINE BASE LOCK PIN

Parts #	Description
199-0104-129	MAGAZINE LIP PINS X 2
199-0104-130	MAGAZINE EXPANSION TUBE
199-0104-131	MAGAZINE FOLLOWER SPRING
199-0104-132	MAGAZINE FOLLOWER LOCK SPRING
199-0104-133	MAGAZINE NOZZLE SEAL
199-0104-134	MAGAZINE BASE SEAL
199-0104-135	INJECTION FILL VALVE
199-0104-136	RELEASE VALVE



UNIVERSO SNIPER  
AIRSOFT



**KWA Performance Industries, Inc.**

18571 E. Gale Ave

City of Industry, CA 91748

T: 626.581.1777 • F: 626.581.0777

[www.kwausa.com](http://www.kwausa.com)