

UNIVERSITY SNIPER AIRSOFT



King Arms

# KA900 Series Instruction Manual

Please read through all instructions before operating the rifle.



## **⚠ WARNING**

- User of this Air Electric Gun must be 18 years of age or older.
- The shooting range of the plastic BB bullet can reach up to 100 meters, beware at all time. Careless shooting may cause eye or other injuries.
- Read through this Handling and Instruction Manual carefully before operating this AEG.

[www.kingarms.com](http://www.kingarms.com)

# WARNING

Please read through this Manual carefully before operating this gun.

This sport gun is developed for recreational use and it is capable to shoot BB bullets as a projectile so please be caution when handling or using this gun. Please pay special attention for safe operation and remember the warnings and be cautions at all times. Careless shooting or improper use is dangerous, and it can cause damage or injury on human or animal.

Operating this sport gun must be aged over 18 years old. Users must understand and follow the laws of country before possessing or operating this product.

Always wear eyes protective gear.

NEVER look into the gun muzzle.

NEVER point the gun or to shoot towards a person or an animal.

Store the airsoft gun at places out of reach by children.

Always put the gun in a case or bag when you are carrying it.

Always put your finger away from the trigger except you are ready to fire the gun.

Set selector lever at the "SAFE" position, and remove the magazine when the rifle is not in use.

Even if the magazine is removed, there might be remaining BB bullet in the gun which still can be shooting.

Use only the designated battery charger to charge battery.  
Do NOT use battery which is swell-up or damaged.  
Do NOT expose battery to water or fire.  
Do NOT drop, throw or bend the battery.  
Do NOT expose the battery to extreme high or low temperatures.

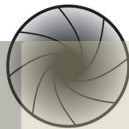

UNIVERSO SNIPER  
AIRSOFT

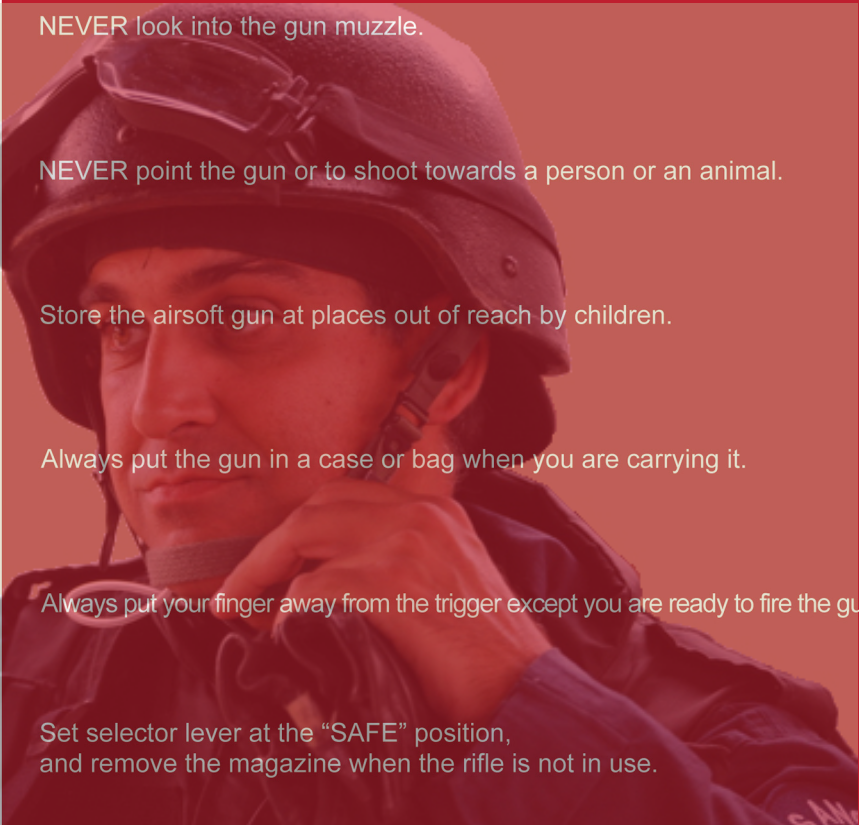

## Caution

- Read through this manual before shooting. Pay special attention for safe operation.
- Remember the warnings and be cautions at all times
- Failing to do so may cause injury, accidents or damage to gun.

## Charging The Battery

- Charging the battery. ( Battery and charger sold separately)

Use the specified battery for the gun.  
8.4V Mini Type Battery.

Avoid use of non-standard battery or the original designed functions may not be working.

- Use the specified battery charger which is applicable to the above battery.

Use only the correct battery and charger. We would not be held responsible for any accidents or damages caused by improper or incorrect operation, or usage of non-specified battery.

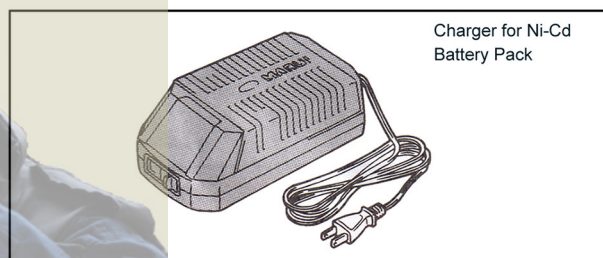
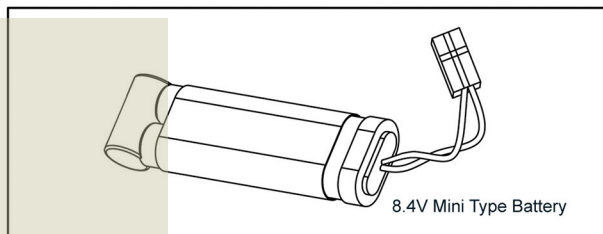

## Component Names

The KA900 Tactical is designed to be ambidextrous operated Personal Defense Weapon. The charging handle, sights, mag release and selector are build to be easy operated for left hander.

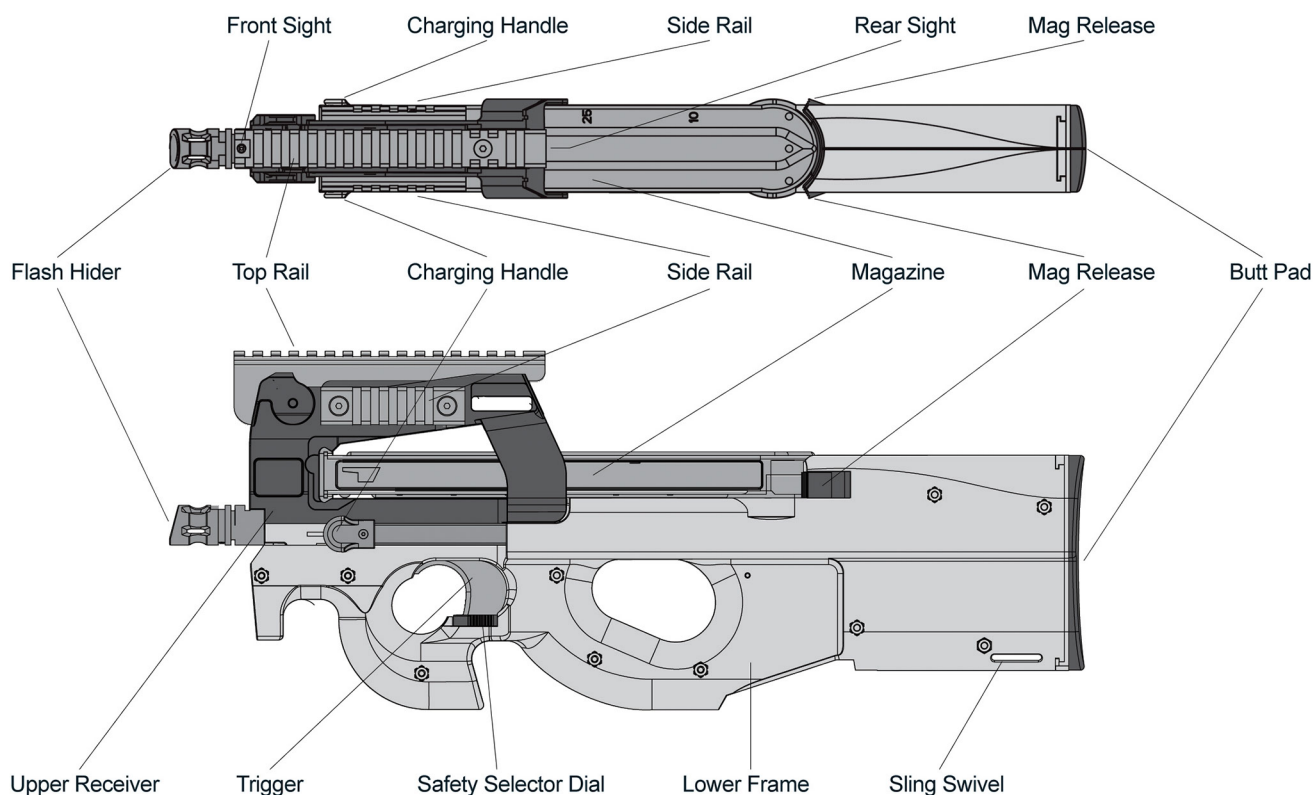

## Installing The Battery

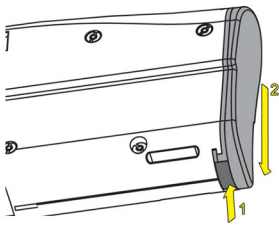

1. Press the button on the bottom of the butt-pad and slide the butt-pad downward to open it.

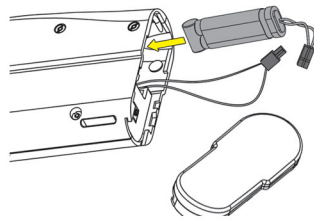

2. Insert the battery into the compartment. Connect the plugs and put the remaining wires inside of the compartments as well.

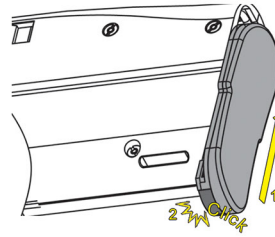

3. Slide the butt-pad back on the gun all the way until a "click" sound was heard.

- Do not use battery which is damaged or swelled.
- Remove the battery from the rifle when it is not in use.
- Make sure the battery cord is fixing securely inside the battery compartment.

## Loading The Magazine

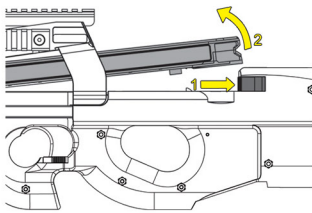

1. First press the mag release button and then take the magazine off the rifle.

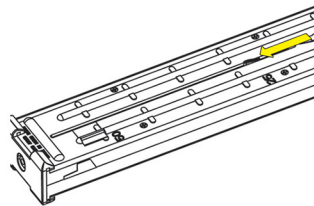

2. On the bottom of the magazine, pull the loading plunger all the way back.

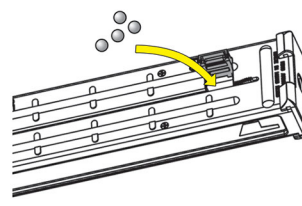

3. Then open the loading door in order to lock the plunger in place. Put BBs into the magazine and then close the door.

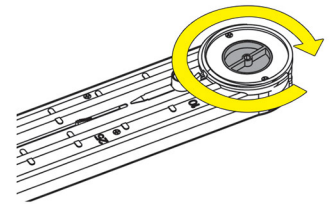

4. Rotate the winder clockwise to load up BBs.

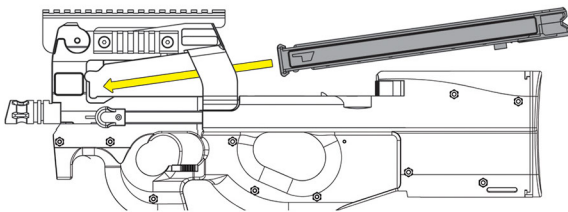

5. After the magazine is fully loaded, put the magazine back to the rifle as shown.

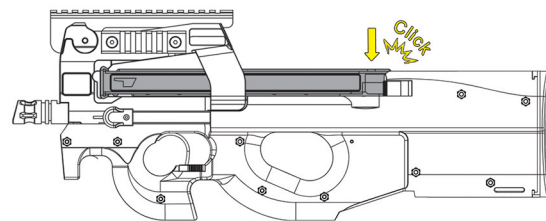

6. Make sure the magazine is secured. You will hear a "click" sound if the magazine is locked with the gun.

Always use new BB bullets or jamming and damage of rifle may occurs.

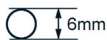

Do not use the following BBs:



- Remove the magazine from the rifle and make sure there is no bullet remains in the chamber when the rifle is not in use.
- Please beware that the maximum loading capacity for the KA900 Hi-cap Magazine is 300 rounds of 6mm BB. Do not overfeeding the magazine or it will damage the magazine and the rifle.
- If the magazine is overloaded, it may not be able to insert to the rifle, and might even cause damage to the gun. Do not overfeed the magazine and keep in under the maximum loading capacity, which is 300 rounds (even there might be still room to install more than 300 BBs in the magazine, KA is not recommend user to do so and will not be held responsible for related damages.).

## Selector Dial & Safety Setting

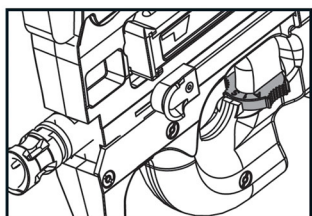

**Safety:**  
Always set the dial to the SAFE position when you are not firing the gun or during storage.

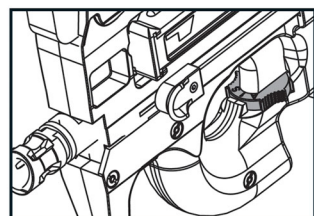

**Semi-auto:**  
The gun will fire one shot each time when the trigger is pulled.

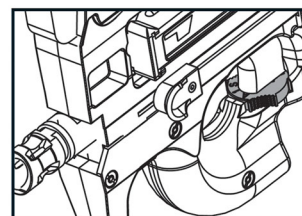

**Full-auto:**  
The gun will fire automatically while the trigger remains pulled.

- Always set the safety selector to "SAFE" position when you are not firing the gun.
- Do not point the rifle at any person or animal at all time, even when the rifle is in "SAFE" mode.
- Do not pull the trigger when the rifle is set to "SAFE" mode or it may damage the rifle.
- To prevent malfunction, please do not adjust the selector lever from semi to full auto while pulling the trigger.



## Firing The Rifle

1. Hold the rifle as shown.
2. Set the selector dial to Semi or Full-auto.
3. Pull the trigger to fire the rifle.

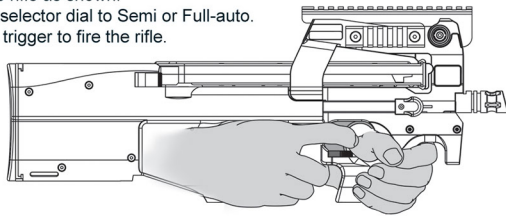

### WARNING

- Make sure you followed all safety instructions before firing the gun.
- Do not load the rifle until just before you fire it.
- Always set the selector dial to Safety position when you are not ready to fire it.
- Always keep your finger away from the trigger unless you want to fire the rifle.

- If magazine became empty while shooting or an empty magazine is installed on the rifle, do not empty firing the rifle or the rifle will be damage.
- Change the battery if the fire-rate becomes slow.
- It is normal that a blank fire may occur at the first shot even if the gun is loaded.
- There are possible cases which non-firing may occur after trigger is pulled in the semi-auto mode. To solve this issue, fire 5 to 10 bullets in the full auto mode first, and then switch back to semi-auto mode.
- It is normal that some smell may be generated from the motor for a while when a new gun is operating.
- It is normal that the hop-up function may be unstable for 200-300 bullets after silicone oil has been applied on hop up unit.

## Aiming & Sights Adjustment

The KA900 Tactical equipped with two side rails and top rail for mounting red dot sight or other aiming system (not included in packing). There is a build-in adjustable iron sight on the top rail and two fixed backup iron sights on both sides of the optical sight base.

To aim to target, align the iron sight with the rear sight hole to aim the iron sight post through the rear sight hole.

User can rotate the front sight post to adjust the iron sight's level by using the adjustment tools which comes with the package. In order to adjust the build-in iron sight to left or right, adjusting the side screw indicated by hex key.

Front sight adjustment tool

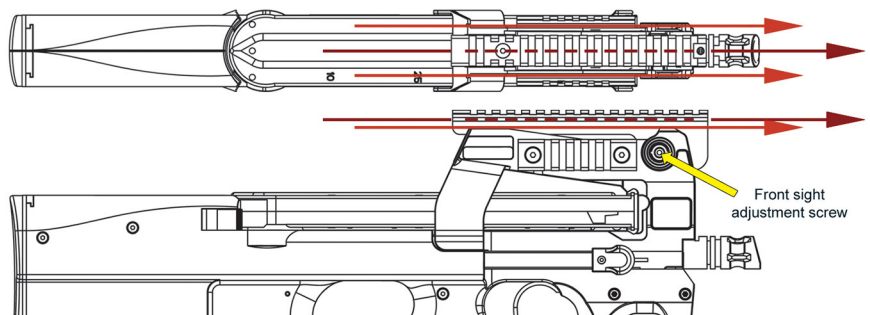

## Hop Up Adjustment

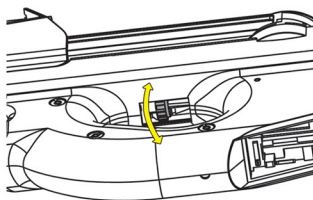
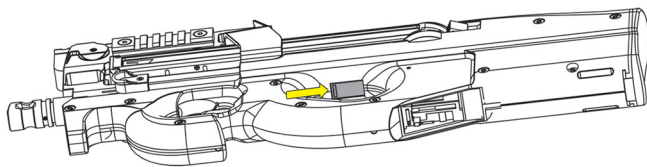

▲ To adjust the hop up, open the cover indicated and the hop up adjustment switch will be seen.

◀ Turn the dial to right side to increase hop up while turn it to left to decrease hop up.

- Turning the hop up dial excessively can cause bullet clogging.
- Keep pulling the trigger while bullet being clogged will damage the piston and gears.
- If bullet clogging occurs, immediately stop firing the gun, return the hop dial to the normal position and remove clogging bullets using a cleaning rod.
- Make sure to return the hop up to normal position when removing clogged bullets. Otherwise, the chamber packing may be damaged.
- Never to use used or dirty bullets. Dirty chamber will result in unstable hop up.
- Lacking or over spraying of silicone oil will also lead to unstable hop up.

Excessive hop up (Turn the dial to left side.)

Best position

Not enough hop up (Gradually turn the dial to right side.)

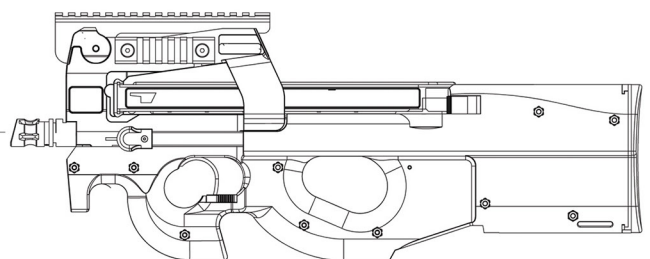

## Gearbox Spring Tension Releasing

During the shooting process, the piston might not be able to finish the whole shooting cycle and is stopped in the middle. This will cause the spring to constantly being compressed and hence the shooting power will be decrease in long run.

Therefore, to ensure the piston to finish the whole shooting cycle and able to release the spring tension is important for the gearbox to be maintain in its best working condition. The easiest way to avoid this issue is to dry-firing 3-5 shots in semi-auto to let the piston to complete its cycle.

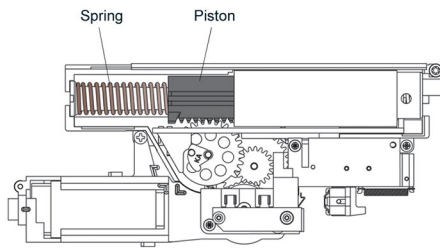

In this situation, the piston is stopped in the middle of the shooting cycle. The spring is now being compressed and it will cause damage to the spring.

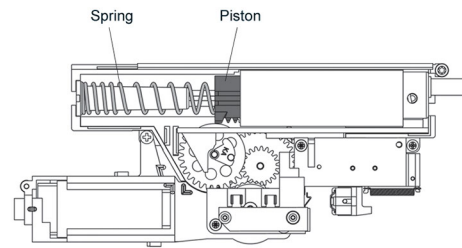

After dry-firing 3-5 shots in semi-auto mode, the piston will complete its shooting cycle and going back to its original position, so the spring is not being compressed here.

## Disassemble The Rifle

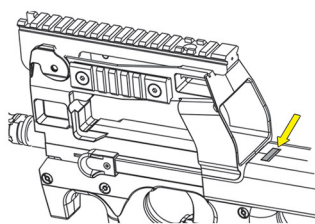

1. To separate the upper and lower receiver, remove the magazine from rifle and press the indicated button.

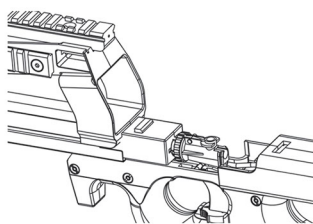

2. Then you can slide the upper receiver off the lower frame.

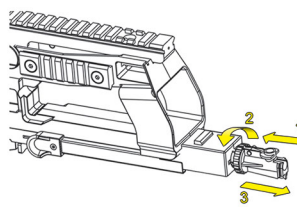

3. Push the hop up chamber towards the outer barrel and rotate it 90 degree anti-clockwise to take the chamber and inner barrel off the upper receiver.

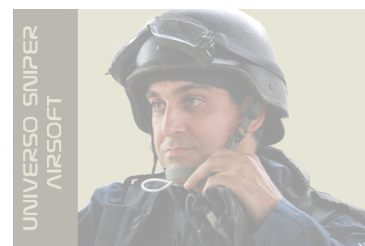

## Cleaning The Inner Barrel & Chamber

1. In order to clean the inner barrel, first remove the magazine and then put the rifle up side down to let the bullet feeding port points down.

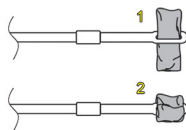

A cleaning rod is included in the package. There is a hole on one end, user can place a piece of cleaning cloth and slide it in the inner barrel to clean the barrel.

2. On the other end, there is a plastic tip for user to push the jammed BB from the inner barrel.

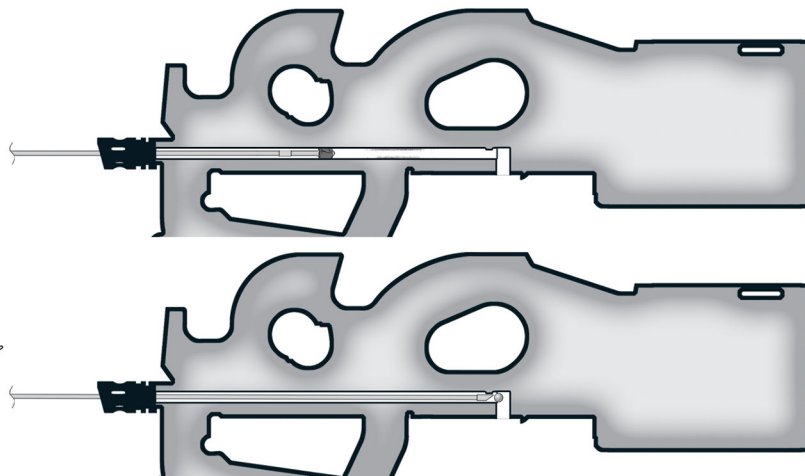
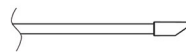

## Spring Replacement

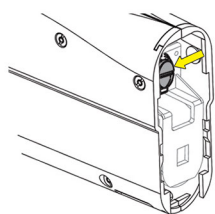

1. Open the butt cover, unscrew the indicated spring guide cover out from the gearbox and you will be able to see the rear end of the spring guide.

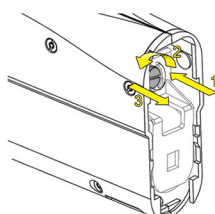

2. Push the spring guide towards the inside of the gearbox by screw driver, and then rotate the spring guide 90° to take the spring guide and spring out from the gearbox.

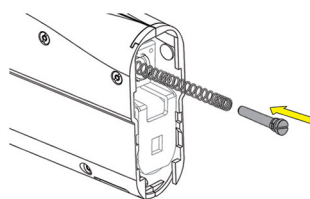

3. Replace the spring and insert it back into the gearbox with the spring guide.

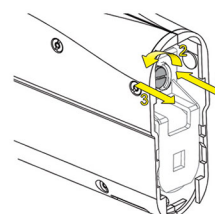

4. As per step 2, insert the spring guide back into the gearbox by screw driver, then rotate it 90° to lock the spring guide and spring inside the gearbox. Then put the spring guide cover and butt pad back on.



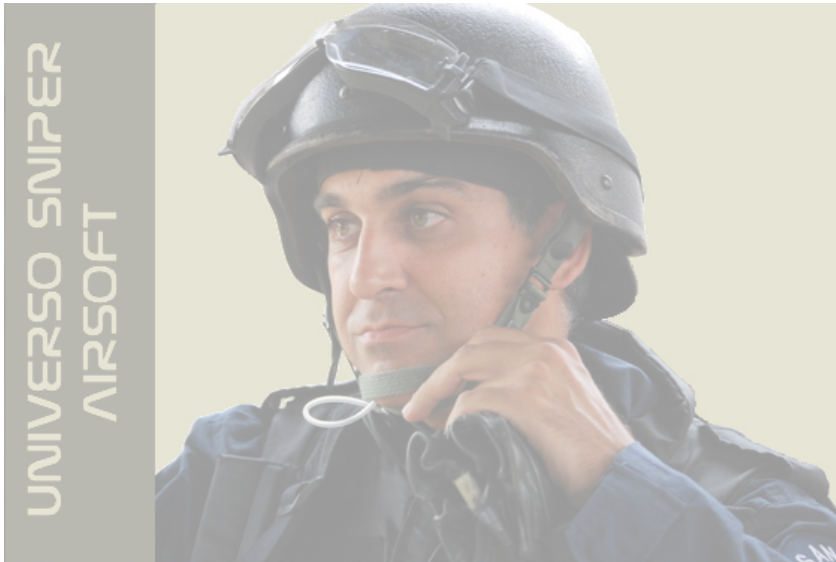

Thank you very much for buying King Arms product.

Airsoft Gun, Parts and Accessories Manufacturer



[www.KingArms.com](http://www.KingArms.com)