



Please read through all instructions before operating this AEG

*AUTOMATIC ELECTRIC GUN SERIES*

UNIVERSO SNIPER  
AIRSOFT



*M4 Handling and  
Instruction Manual*

**⚠ WARNING**

- User of this Air Electric Gun must be 18 years of age or older.
- The shooting range of the plastic BB bullet can reach up to 100 meters, beware at all time. Careless shooting may cause eye or other injuries.
- Read through this Handling and Instruction Manual carefully before operating this AEG.



**CALIBER** : 6 mm BB bullet  
**MAGAZINE CAPACITY** : 300 Rounds  
**METHOD OF OPERATION** : Electric power  
**BATTERY TYPE** : Intellect 1400mAh crane stock type  
**WEIGHT W/O MAGAZINE** : 3.04 kg  
**LENGTH (Stock retracted)** : 74.5 cm  
**LENGTH (Stock extended)** : 83 cm  
**BARREL LENGTH** : 30.5 cm  
**MUZZLE VELOCITY** : 320-340 FPS (Japan Ver.: 78-85 m/s)  
**MAIN MATERIAL** : Aluminum; Nylon Fiber

## Setting the Battery

Always treat your battery with care. do not attempt to disassemble or modify the battery. Do not alter the cord or plug. Make sure the battery is in good shape before charging. Use standard charger when charging, charging electric current should be under 1.5 A. Never charge the battery if it is damaged. Stop charging when battery is overheat.



1. Pull the stock out from AEG.

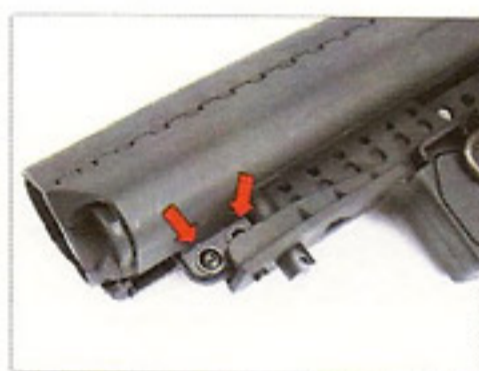

2. Loosen two screws shown.



3. Take the buttpad out from the stock by loosening the screw shown.



4. Remove the covers from the accessory compartments.

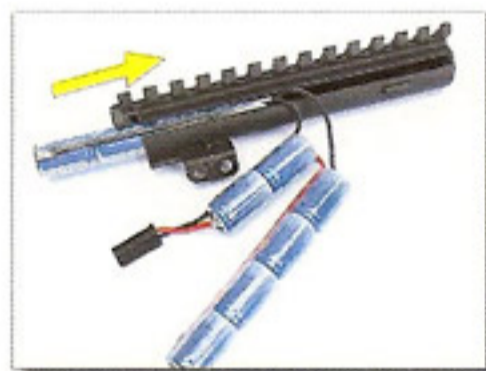

5. Insert the battery to accessory compartment as shown.



6. Put the cover back on the accessory compartment.



7. Put the other side of battery across the stock as shown.

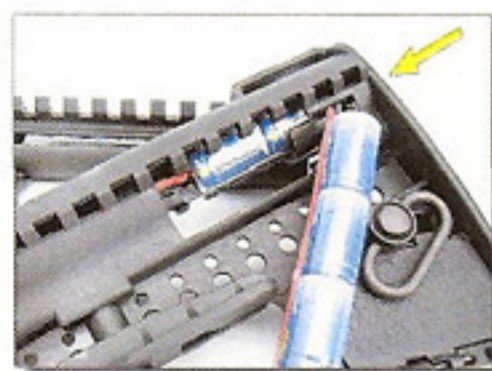

8. Place the single piece battery in the middle of the stock, and put back the stock cover (yellow arrow) to hold the battery on position.

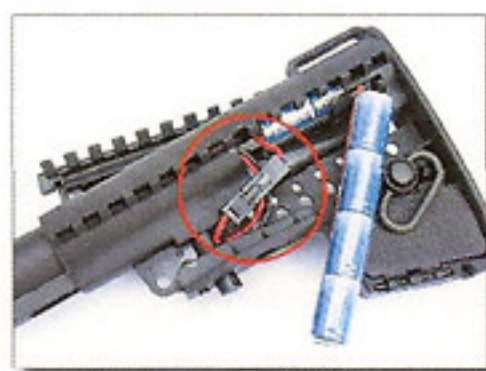

9. Connect the plug as shown. Place the wire and plug inside the stock pipe and make sure the stock can move smoothly.



10. Insert other side of the battery to accessory compartment as step 5-6.



11. Fix the buttpad and three screws indicated to complete installation.



**CALIBER** : 6 mm BB bullet  
**MAGAZINE CAPACITY** : 300 Rounds  
**METHOD OF OPERATION** : Electric power  
**BATTERY TYPE** : Intellect 1400mAh crane stock type  
**WEIGHT W/O MAGAZINE** : 3.09 kg  
**LENGTH (Stock retracted)** : 74.5 cm  
**LENGTH (Stock extended)** : 83 cm  
**BARREL LENGTH** : 30.5 cm  
**MUZZLE VELOCITY** : 320 FPS ( Japan Ver.: 78-85 m/s )  
**MAIN MATERIAL** : Aluminum; Nylon Fiber



## Setting the Battery

Always treat your battery with care, do not attempt to disassemble or modify the battery. Do not alter the cord or plug. Make sure the battery is in good shape before charging. Use standard charger when charging, charging electric current should be under 1.5 A. Never charge the battery if it is damaged. Stop charging when battery is overheat.



1. Pull the stock out from AEG.

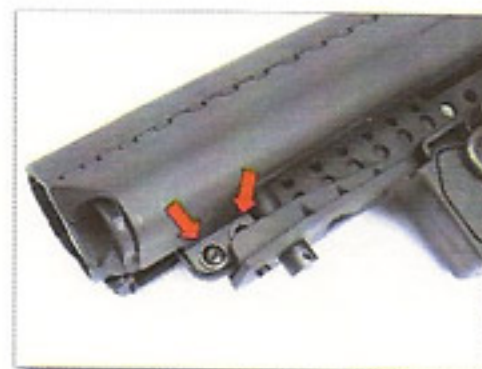

2. Loosen two screws shown.



3. Take the butt pad out from the stock by loosening the screw shown.



4. Remove the covers from the accessory compartments.

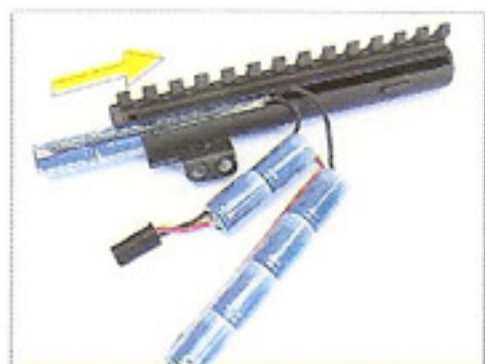

5. Insert the battery to accessory compartment as shown.



6. Put the cover back on the accessory compartment.



7. Put the other side of battery across the stock as shown.



8. Place the single piece battery in the middle of the stock, and put back the stock cover (yellow arrow) to hold the battery in position.



9. Connect the plug as shown. Place the wire and plug inside the stock pipe and make sure the stock can move smoothly.



10. Insert other side of the battery to accessory compartment as step 5-6.



11. Fix the butt pad and three screws indicated to complete installation.



- CALIBER : 6 mm BB bullet
- MAGAZINE CAPACITY : 300 Rounds
- METHOD OF OPERATION : Electric power
- BATTERY TYPE : Intellect 1400mAh crane stock type
- WEIGHT W/O MAGAZINE : 3.22 kg
- LENGTH (Stock retracted) : 84.5 cm
- LENGTH (Stock extended) : 93 cm
- BARREL LENGTH : 40.5 cm
- MUZZLE VELOCITY : 320-340 FPS (Japan Ver.: 78-85 m/s)
- MAIN MATERIAL : Aluminum; Nylon Fiber

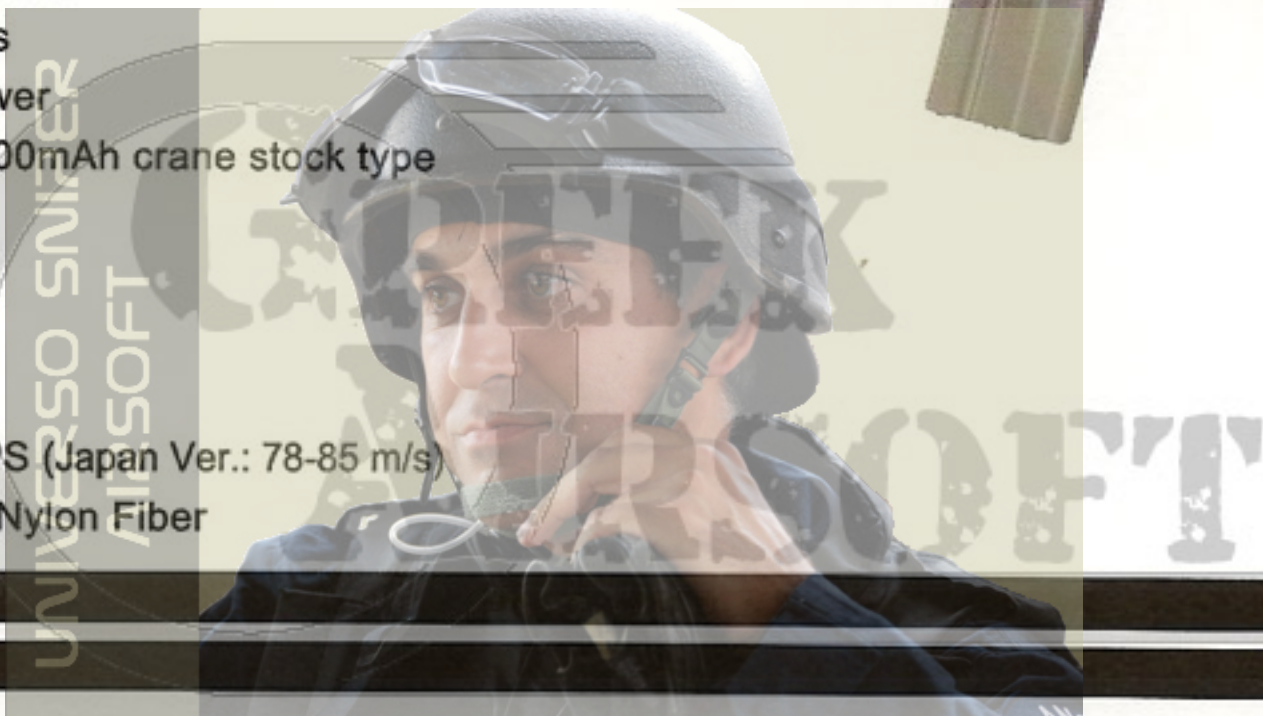

## Setting the Battery

Always treat your battery with care. do not attempt to disassemble or modify the battery. Do not alter the cord or plug. Make sure the battery is in good shape before charging. Use standard charger when charging. charging electric current should be under 1.5 A. Never charge the battery if it is damaged. Stop charging when battery is overheat.



1. Pull the stock out from AEG.

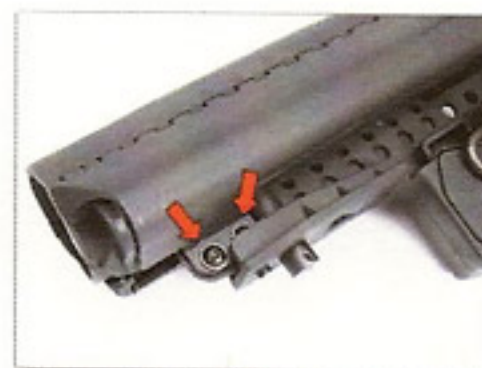

2. Loosen two screws shown.



3. Take the buttpad out from the stock by loosening the screw shown.



4. Remove the covers from the accessory compartments.



5. Insert the battery to accessory compartment as shown.



6. Put the cover back on the accessory compartment.



7. Put the other side of battery across the stock as shown.



8. Place the single piece battery in the middle of the stock, and put back the stock cover (yellow arrow) to hold the battery on position.

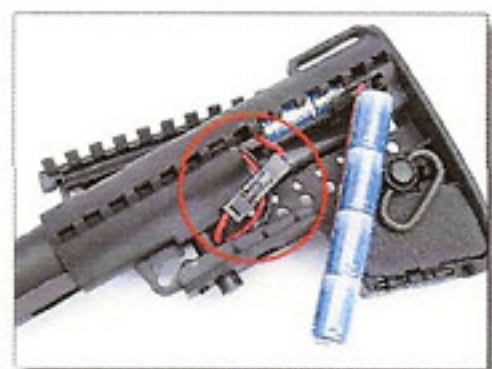

9. Connect the plug as shown. Place the wire and plug inside the stock pipe and make sure the stock can move smoothly.



10. Insert other side of the battery to accessory compartment as step 5-6.



11. Fix the buttpad and three screws indicated to complete installation.

# Read this manual before operating the AEG

This sport gun is developed for recreational use and it is capable to shoot BB bullets as a projectile so please be caution when handling or using this gun. Careless shooting or improper use is dangerous, and it can cause damage or injury on human or animal. Make sure you read through this manual and all the warnings before operating this gun.

Operating this airsoft gun must be aged over 18 years old. Careless shooting or improper operation are dangerous. Users must understand and follow the laws of country before possessing or operating this product.

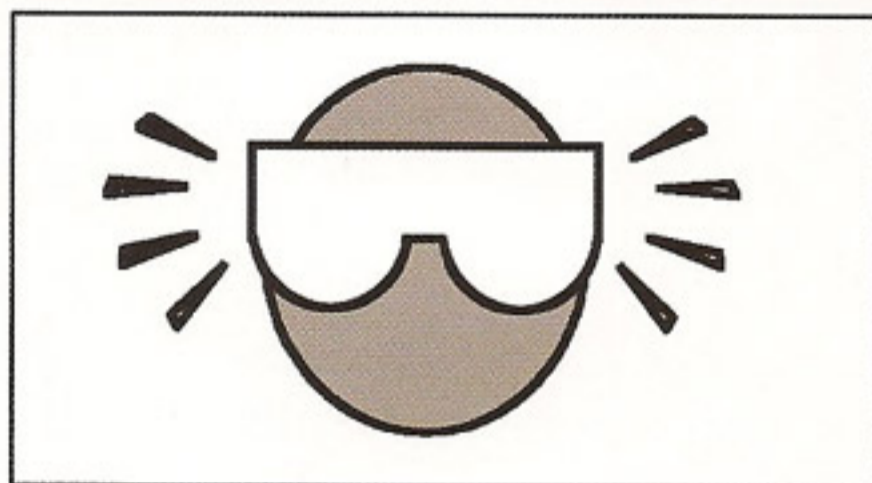

Always wear eyes protective gear.

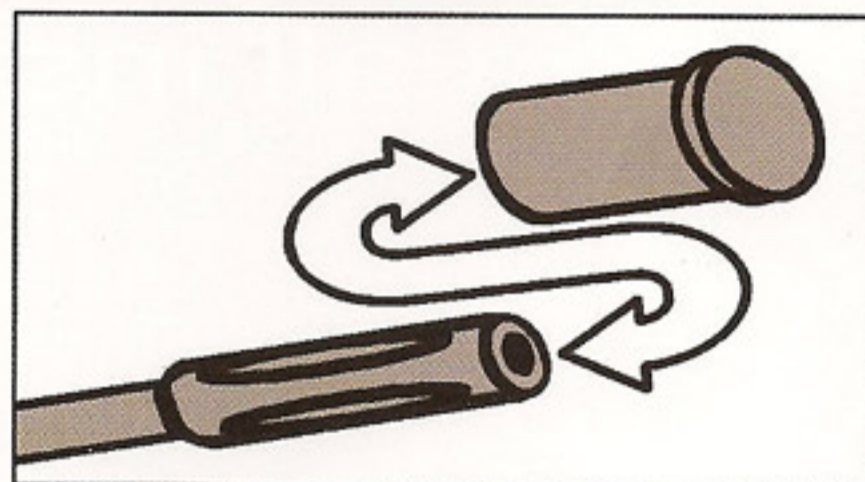

Always attach the protective plug to the gun muzzle.

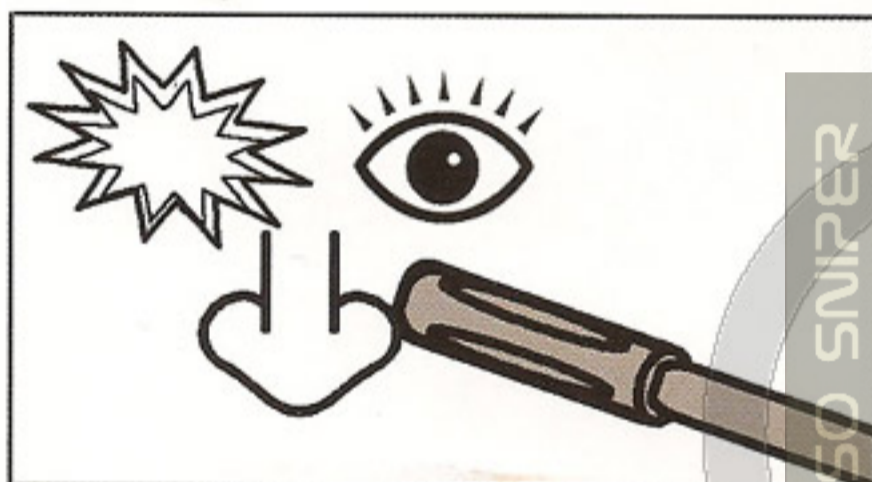

Never look into the gun muzzle.

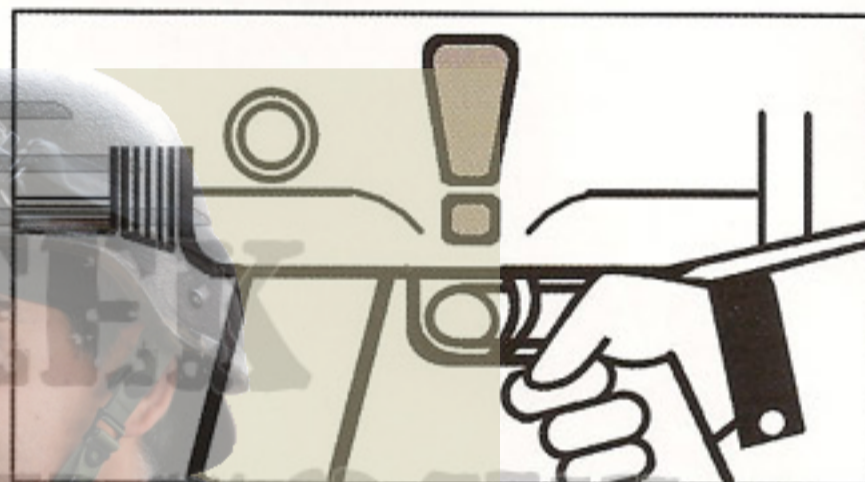

Avoid pulling the trigger carelessly.

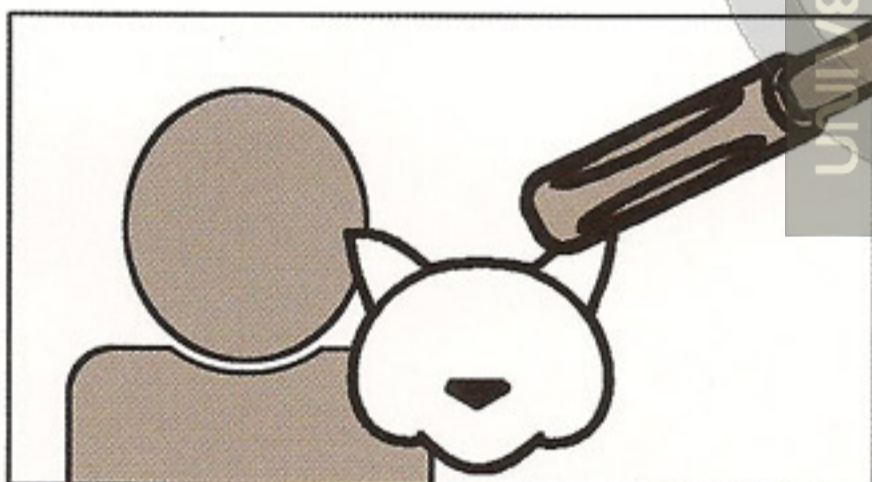

Never point or shoot the gun towards a person or an animal.



Always put the gun in a case or bag when you are carrying it.

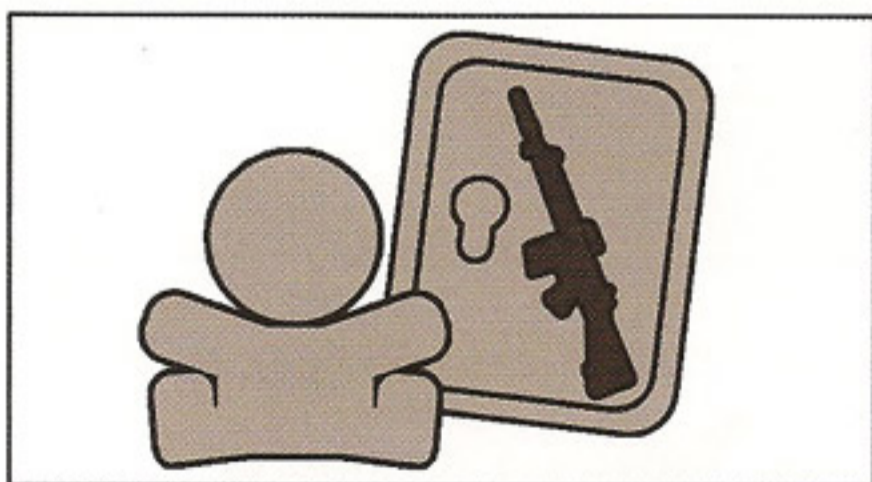

Store the air gun at places out of reach by children.

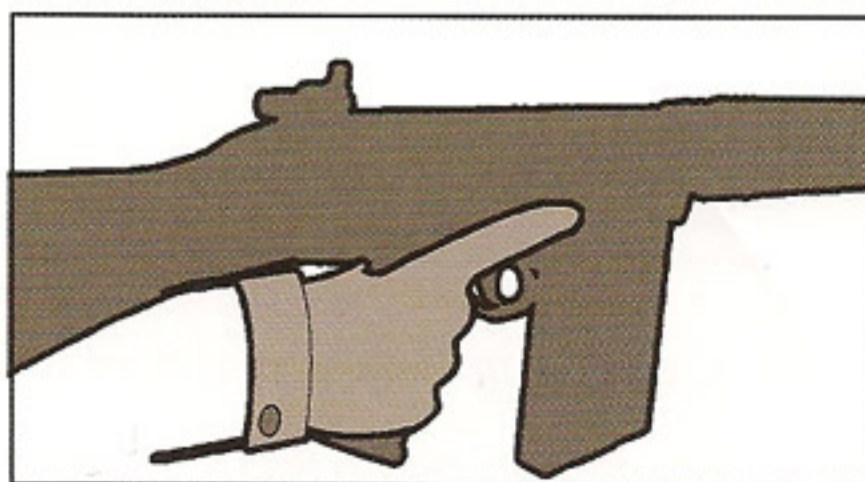

Always put your finger away from the trigger except when you are ready to fire the gun.

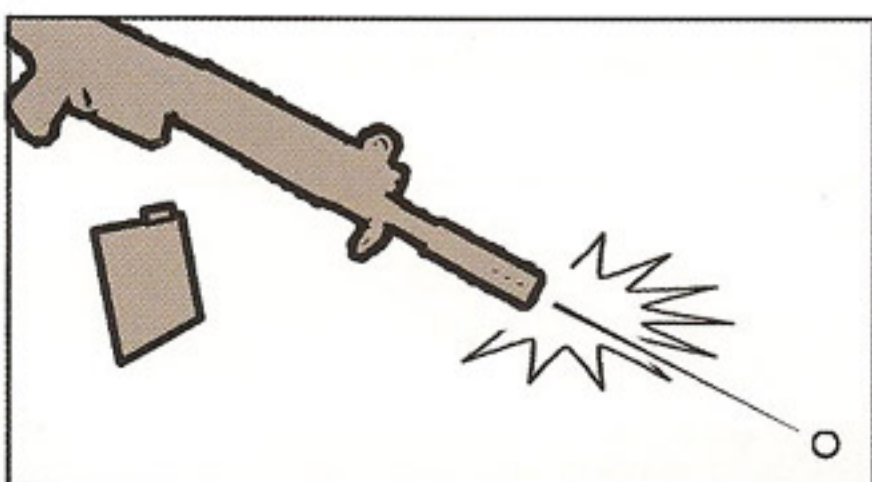

Even if the magazine is removed, there might be remaining BB bullets in the gun which can be shooting.

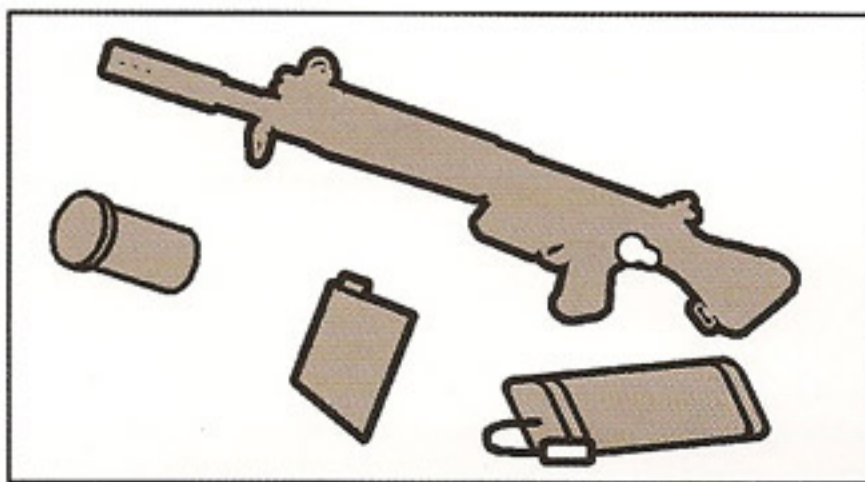

Always apply safety habits  
-Set selector lever at the Safety position  
-Attach the protective plug to the muzzle  
-Remove the magazine  
-Remove the battery from the airgun.

## Caution

- Read through this manual before shooting. Pay special attention for safe operation.
- Remember the warnings and be cautions at all times
- Failing to do so may cause injury, accidents or damage to gun.

## Charging the Battery

### ■ Charging the Battery. ( Battery and charger sold separately)

Use the specified battery for the gun.  
8.4V 1300mAh Battery.

Avoid use of non-standard battery or the original designed functions may not be working.

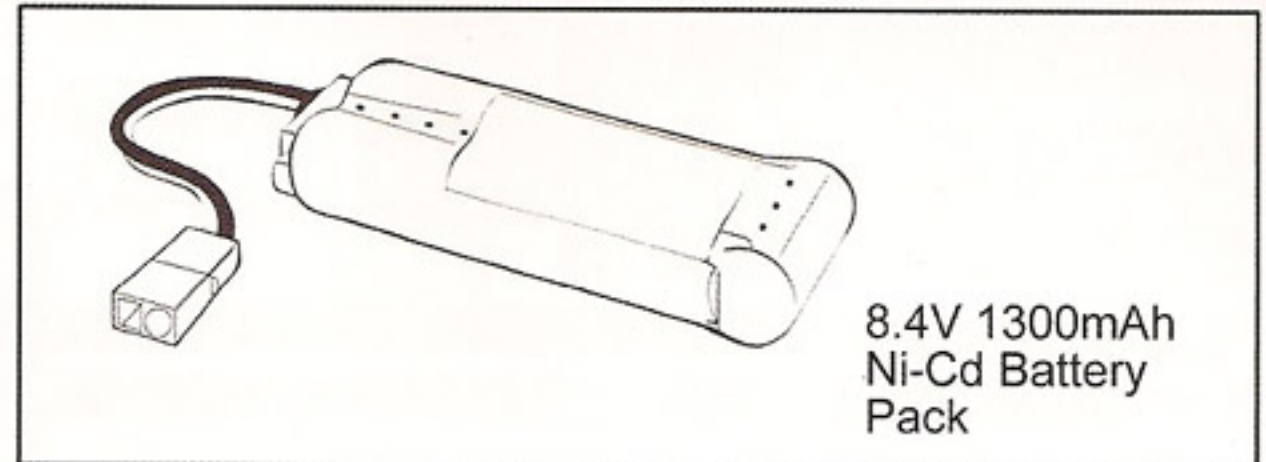

### ■ Use the specified battery charger which is applicable to the above battery.

Use only the correct battery and charger. We would not be held responsible for any accidents or damages caused by improper or incorrect operation, or usage of non-specified battery.

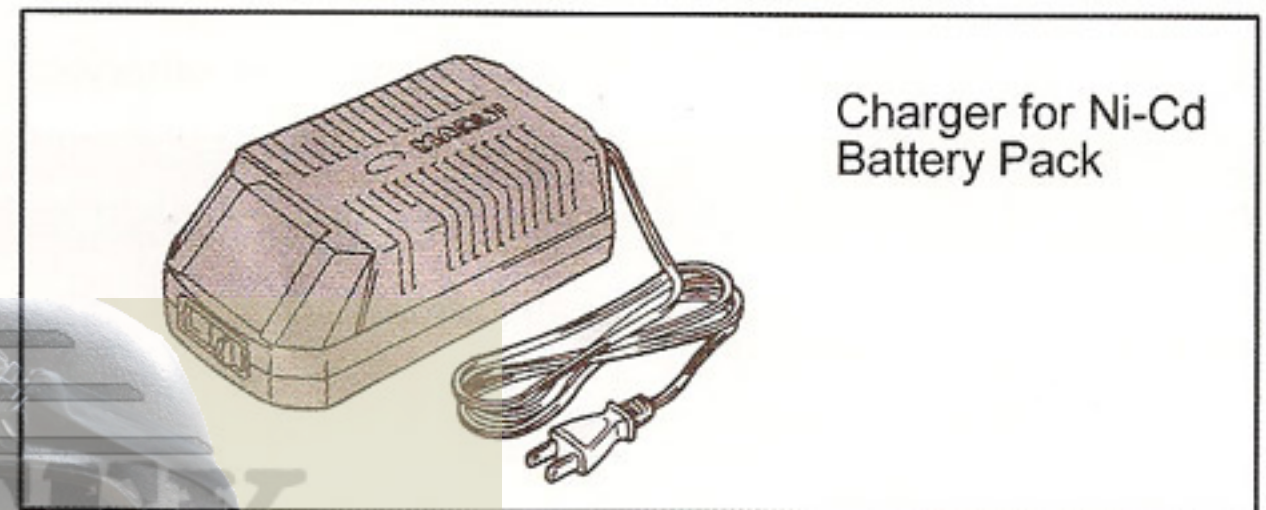

## Component Names

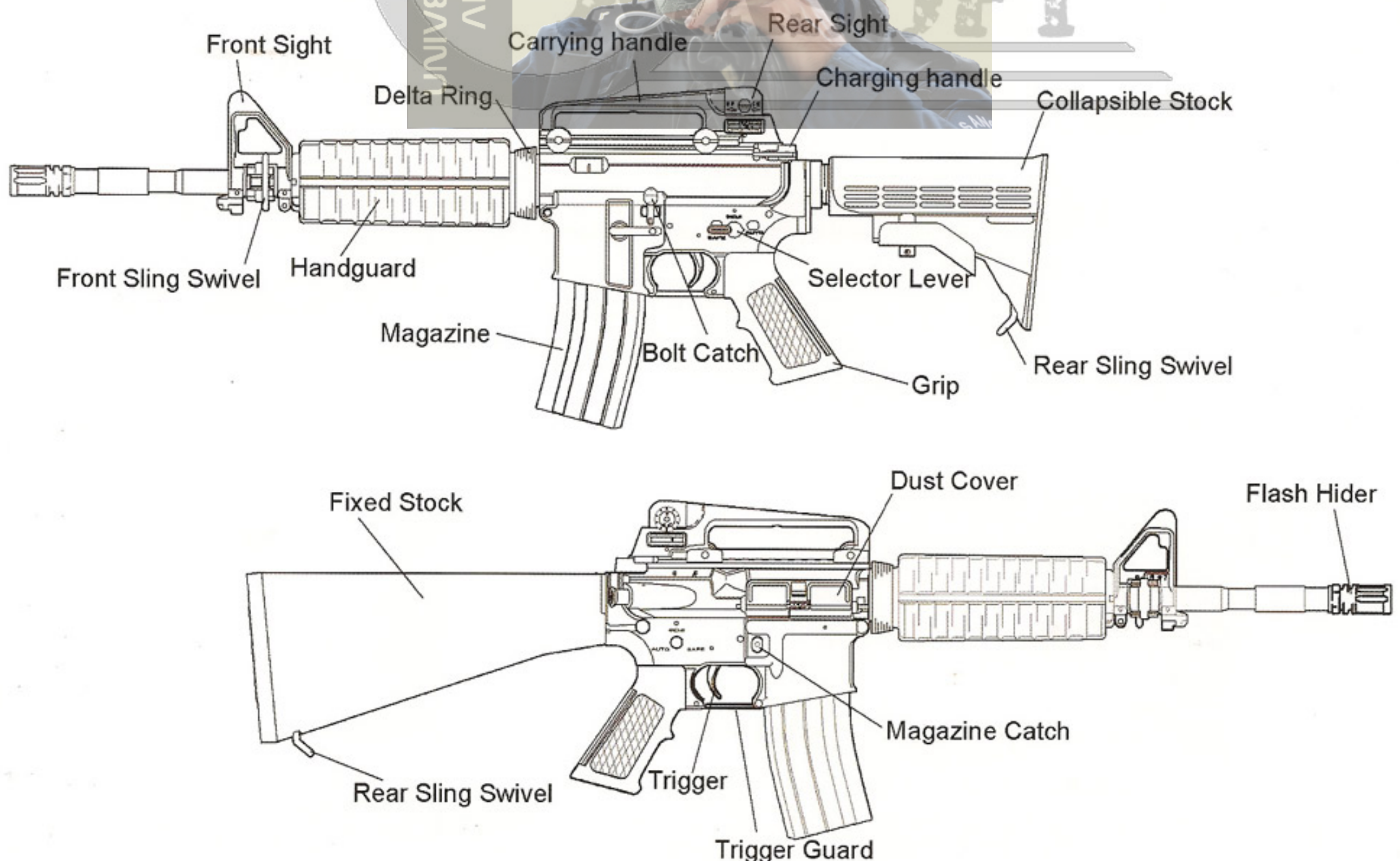

**! Always attach the protective cap during storage.**

## Selector Lever and Safety Setting

### Warning

To prevent malfunction of the switch do not change the selector lever from semi to full auto while pulling the trigger.

#### Safety Setting

Always set the lever to the Safety position and attach the protective cap when you are not firing the gun or during storage.

#### Semi Auto (Single Shot)

The gun will fire one shot each time when the trigger is pulled.

#### Full Auto (Automatic Firing)

The gun will fire automatically while the trigger remains pulled.

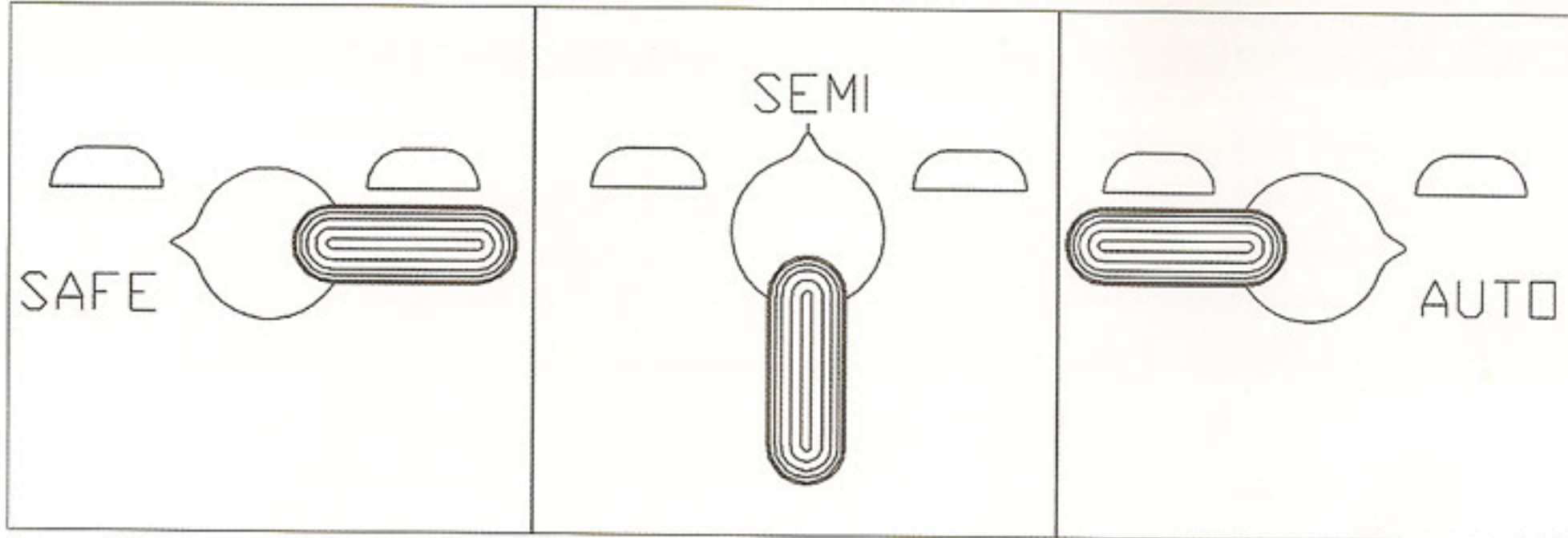

CAUTION: Set the selector lever correctly in position; otherwise, malfunction may occur.

## Setting the Battery

### For M4A1 (Collapsible stock):

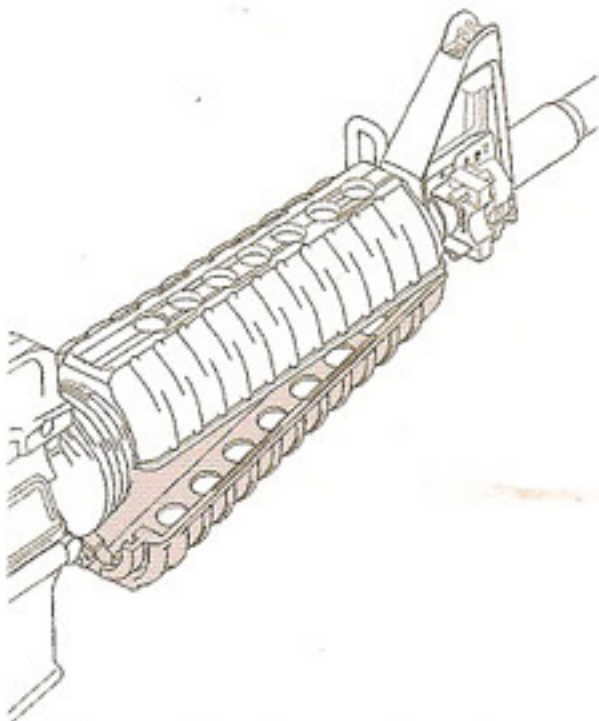

1. Open the lower handguard by pulling the delta ring backwards.



2. Insert the battery in the lower handguard and connect connectors.

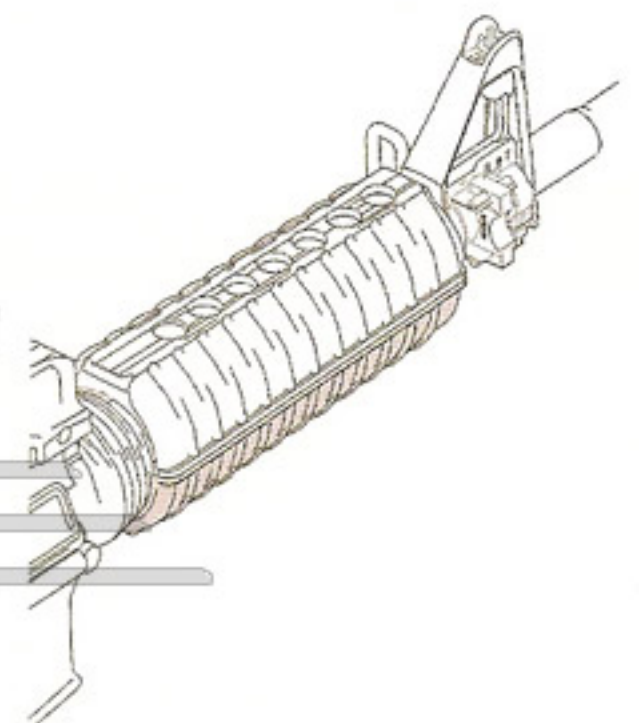

3. Insert connectors and cords inside the handguard.

4. Make sure the battery and cords are stayed on the inside of the lower handguard, and then put handguard back to its original position.

### For M16A1 (Fixed stock):

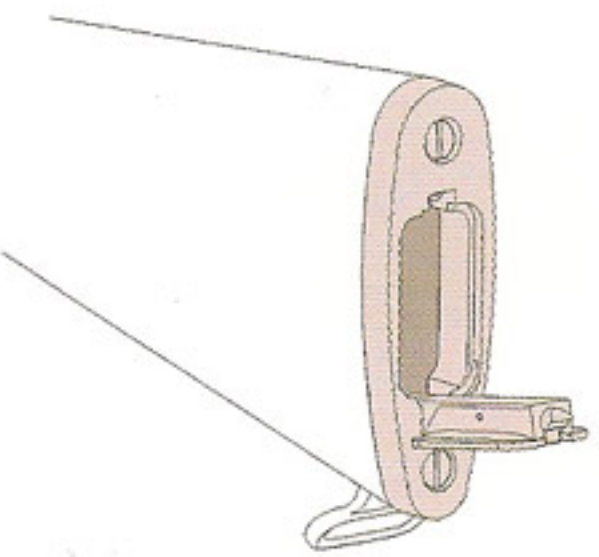

1. Open the cover on the butt stock.

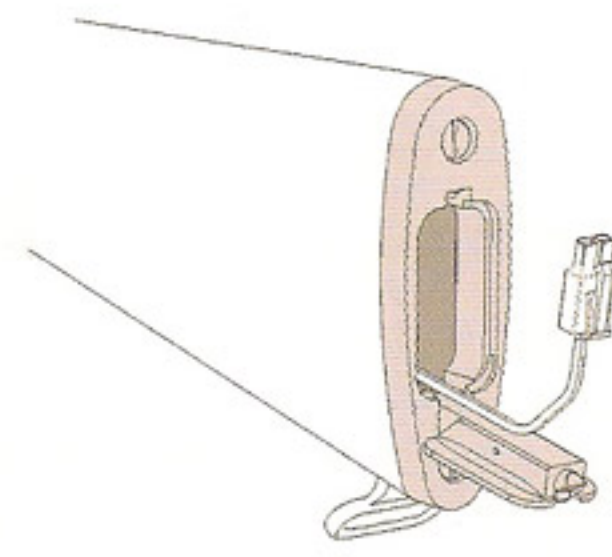

2. Pull out the connector from the butt stock.

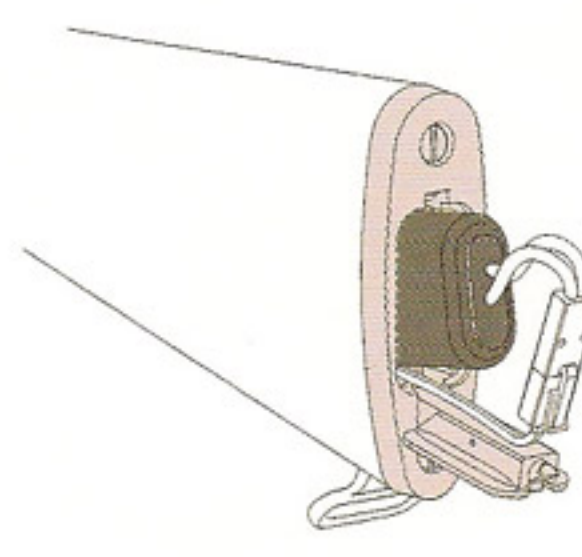

3. Insert the battery in the stock and connect connectors.

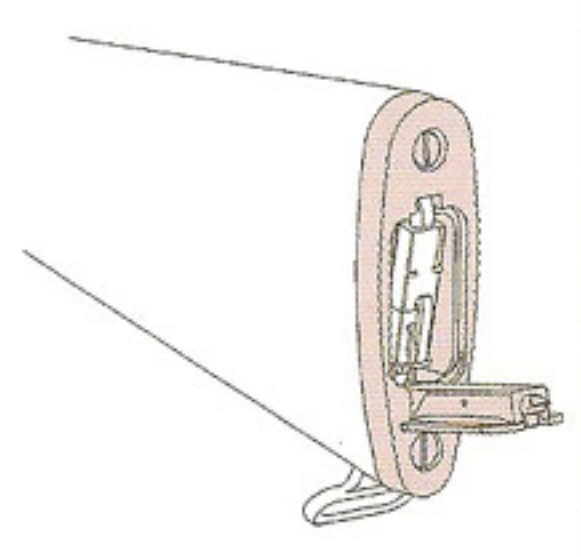

4. Insert connectors and cords in the stock. Close the cover when the battery and cords are set in positions.

## Firing

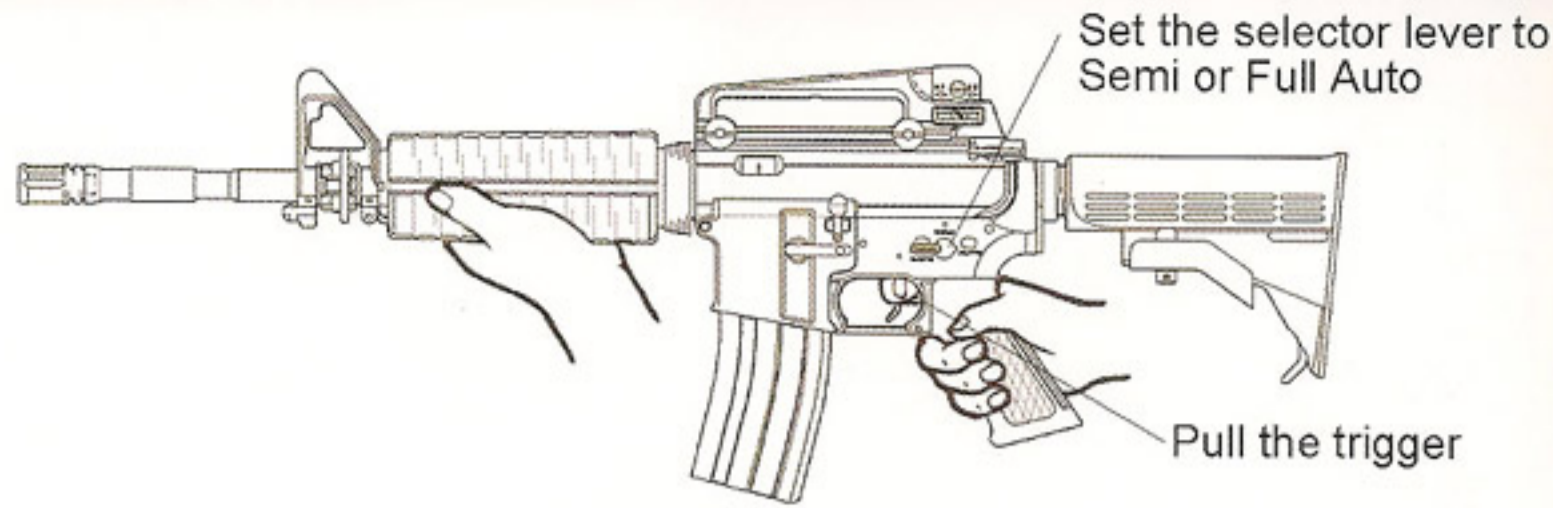

- Change the battery if the fire-rate becomes slow.
- It is normal that a blank fire may occur at the first shot even if the gun is loaded.
- There are possible cases which non-firing may occur after trigger is pulled in the semi-auto mode. To solve this issue, fire 5 to 10 bullets in the full auto mode first, and then switch back to semi-auto mode.
- It is normal that some smell may be generated from the motor for a while when a new gun is operating.
- It is normal that the hop-up function may be unstable for 200-300 bullets after silicone oil has been applied on hop up unit.

## ⚠ WARNING ⚠

make sure you followed all safety instructions before firing the gun.

remove the protective cap only when you are ready to fire.

after firing about 500 bullets, rest the gun for 5 to 10 minutes.

Always attach the protective cap and set the selector lever to Safety position when the air gun not ready to fire.

## Adjust Hop Up

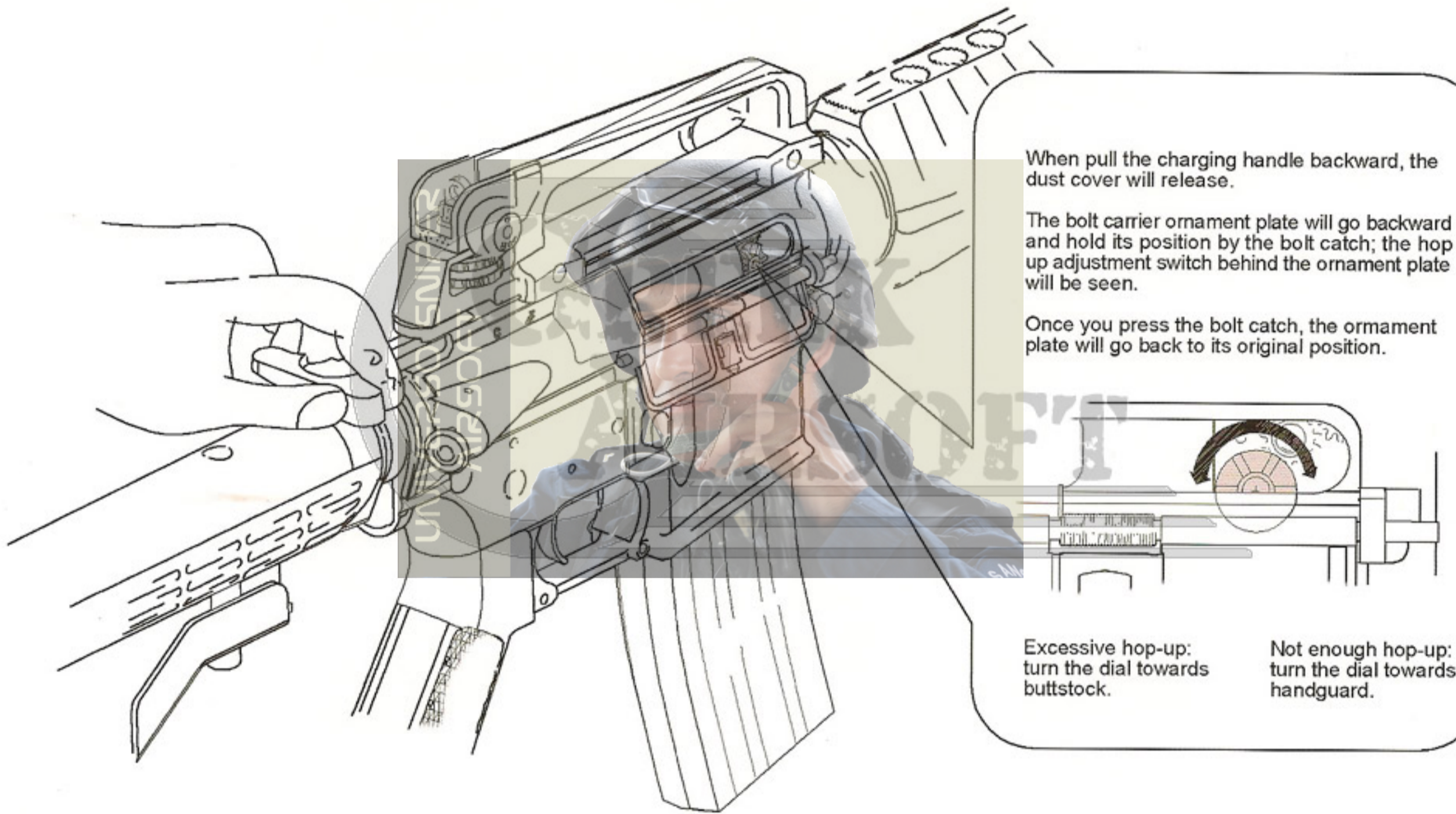

- X** ○ Excessive hop up (Turn the dial towards Normal)
- O** ○ Best Position
- X** ○ Not enough hop up (Gradually turn the dial towards Hop)



- Turning the hop-up dial excessively can cause bullet clogging. Keep pulling the trigger while bullet being clogged will damage the piston and gears.
- If bullet clogging occurs, immediately stop firing the gun, return the hop dial to the Normal position and remove clogging bullets using a clearing rod (not included in this packing).
- Make sure to return the hop-up to normal position when removing clogged bullets. Otherwise, the chamber packing may be damaged.
- Never use used and dirty bullets. Dirty chamber will result in unstable hopping up.
- Lacking or over spraying of silicone oil will also lead the hopping up unstable



# Explosive Diagram

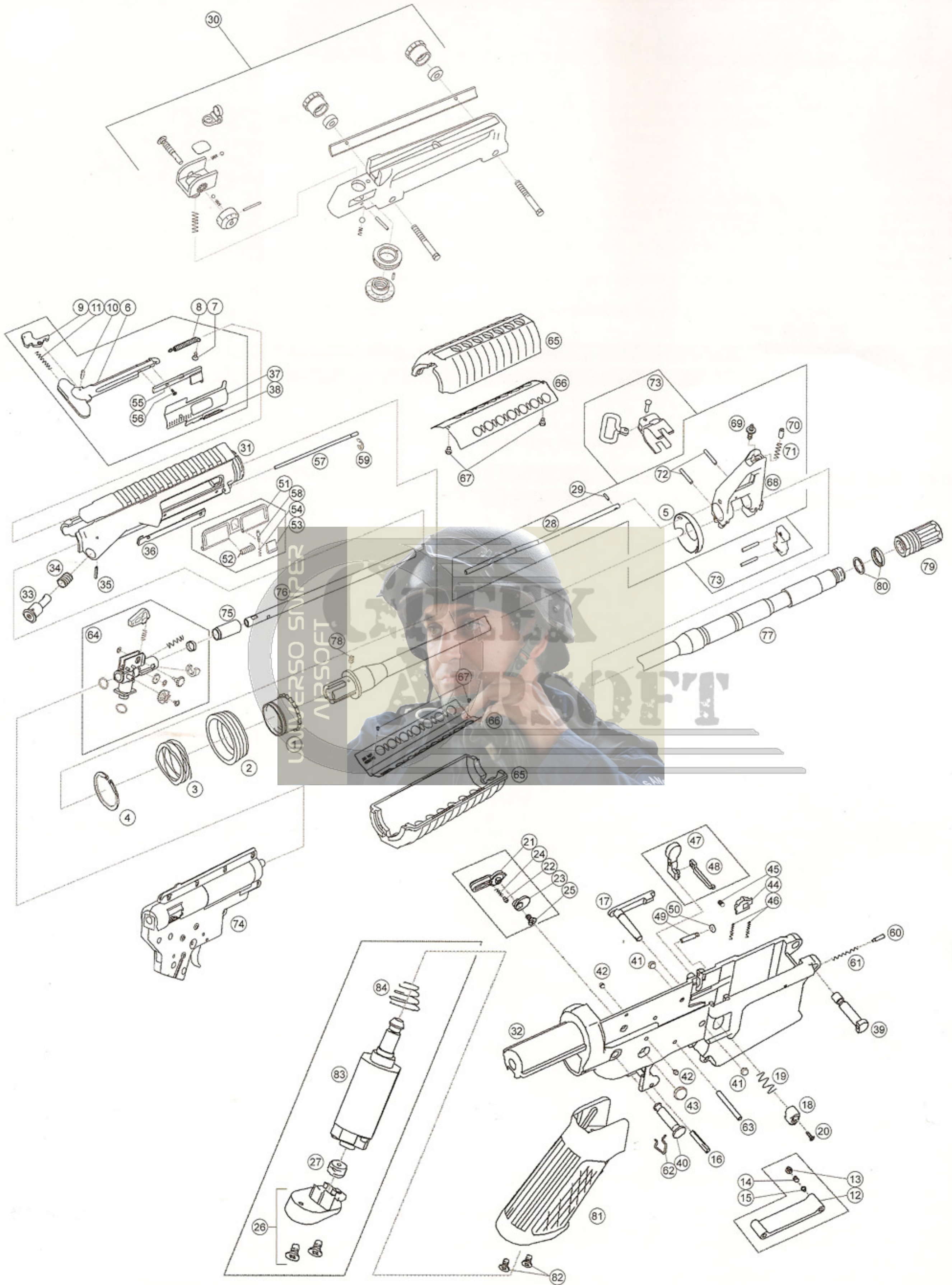

# Explosive Diagram

## Collapsible stock:

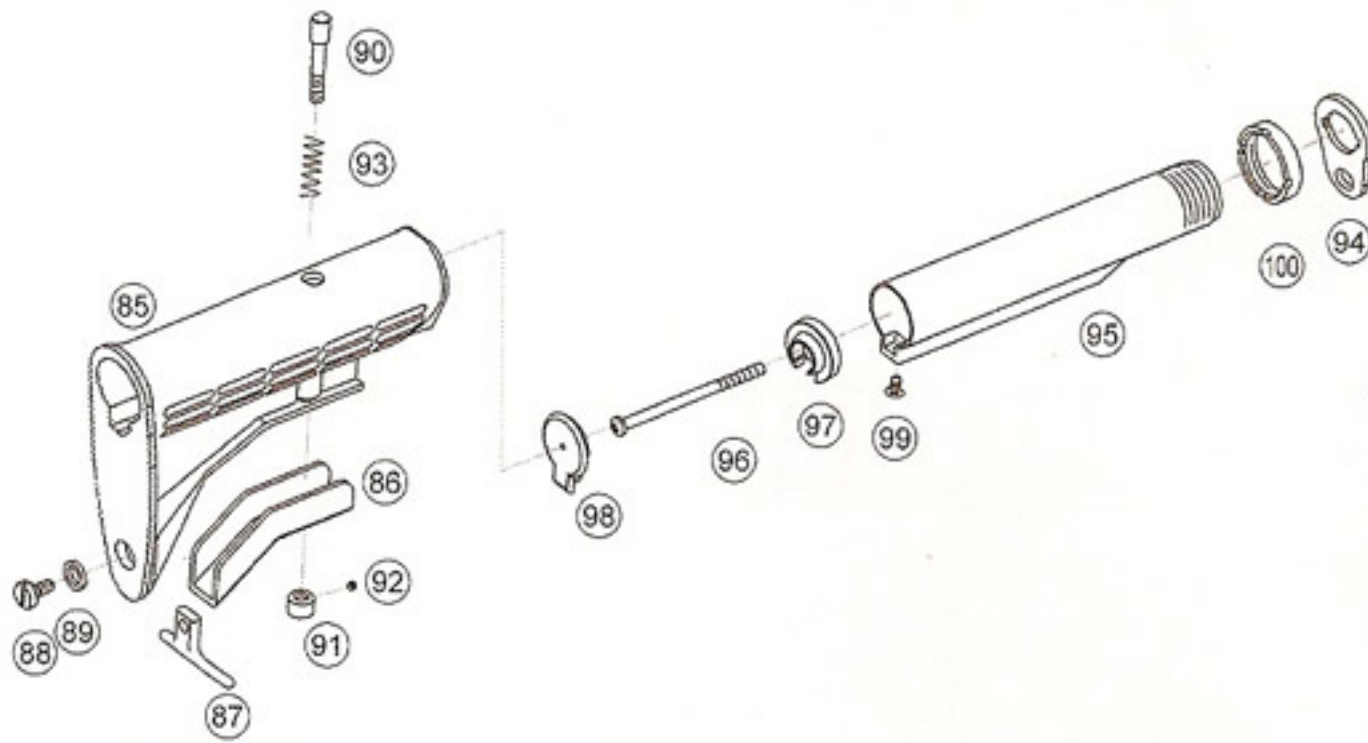

## Fixed stock:

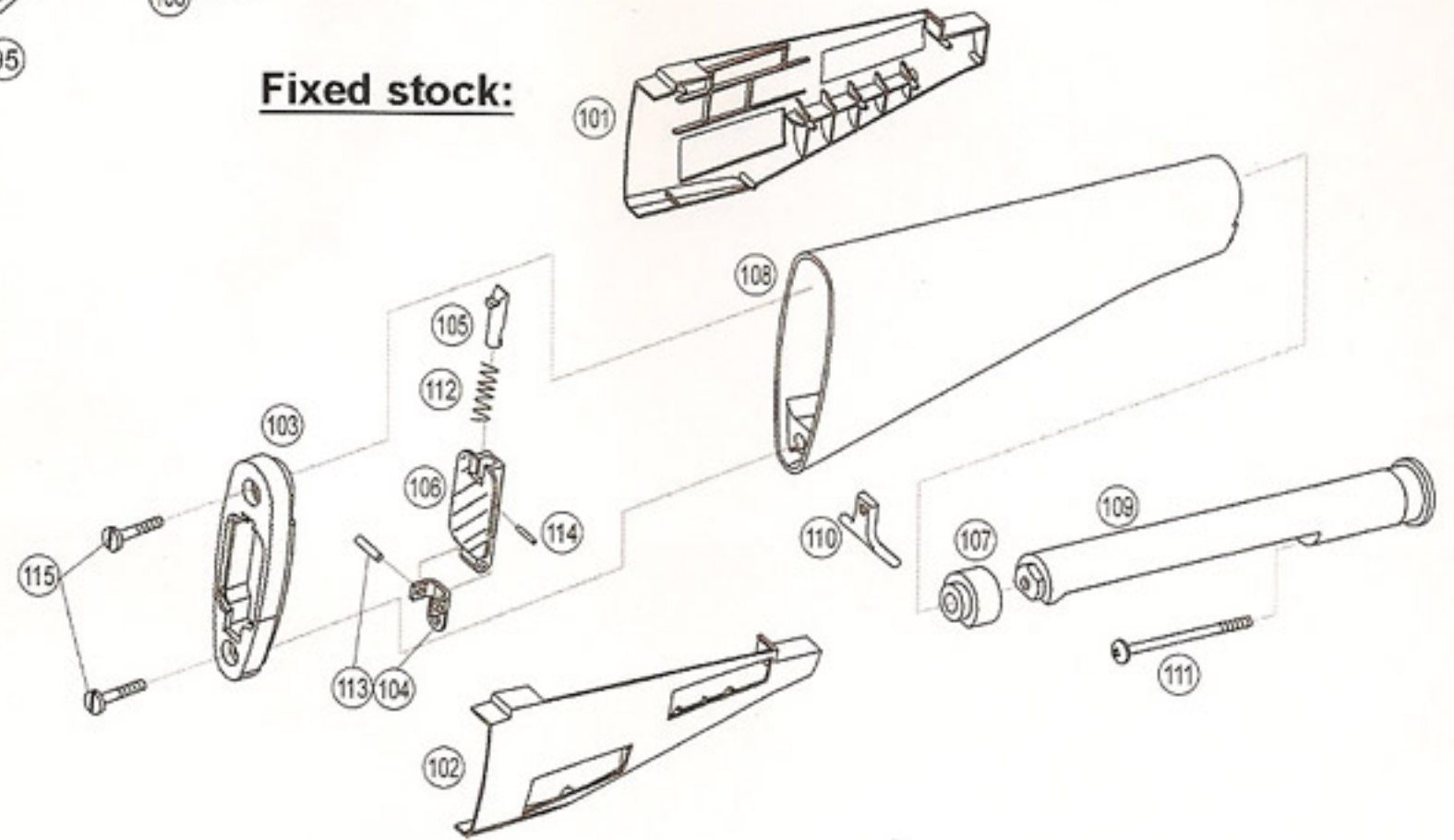

No.	Code	Part name
1	M4-01-01	Barrel nut
2	M4-01-02	Delta ring
3	M4-01-03	Weld spring
4	M4-01-04	Handguard snap ring
5	M4-02	Handguard cap
6	M4-07-01	Charging handle
7	SCR-CR-1 (M3X6mm cross)	Charging handle screw
8	S-R-84	Charging handle spring
9	M4-07-02A	Charging handle latch
10	P-01-O (1mmX6mm)	Charging handle latch roll pin
11	S-R-44 (4mmX27mmX0.4mm)	Charging handle latch spring
12	M4-08-01A	Trigger guard
13	M4-08-02	Trigger guard bouncing pin
14	S-R-45 (3.5mmX6mmX0.5mm)	Trigger guard spring
15	SCR-HE-0 (M4X4mm)	Trigger guard screw
16	P-16-O (3mmX20mm)	Trigger guard pivoted roll pin
17	M4-09-01A	Magazine catch
18	M4-09-02A	Magazine catch button
19	S-R-46 (6.8mmX14.5mmX0.7mm)	Magazine catch spring
20	SCR-HE-1 (M2X8mm hex)	Magazine catch screw
21	M4-11-01	Selector lever
22	M4-11-02	Selector lever fasten pin
23	M4-11-03	Selector lever plate
24	S-R-49 (2.5mmX6.1mmX0.3mm)	Selector lever spring
25	SCR-CR-1 (M3X5mm cross)	Selector lever screw
26	M4-17-01	Grip end with screws
27	TGP-45	Motor adjust screw
28	GAT-01	Gas tube
29	P-32-O (2mmX8mm)	Gas tube roll pin
30	KA-RS-09	Carry handle with rear sight assembly
31	M4-20-01	Upper receiver
32	M4-20-02	Lower receiver
33	M4-20-03	Forward assist plunger
34	S-R-79 (10.2mmX14mmX0.87mm)	Forward assist plunger spring
35	P-28-O (2.1mmX16.3mm)	Forward assist plunger pin
36	M4-20-04	Bolt carrier ornament plate rail
37	M4-20-05	Bolt carrier ornament plate
38	S-R-80 (2.78mmX20.4mmX0.33mm)	Bolt carrier ornament plate spring
39	M4-20-06	Front pivot pin
40	M4-20-07	Takedown pin
41	M4-20-08 (2)	Ornament plates (medium)
42	M4-20-09 (2)	Ornament plates (small)
43	M4-20-10	Ornament plate (big)
44	M4-20-11	Bolt carrier ornament plate detent
45	SCR-HE-0 (M3X4mm)	Bolt carrier ornament plate detent screw
46	S-R-81 (2mmX13mmX0.3mm) (2)	Bolt carrier ornament plate detent springs
47	M4-20-12	Bolt catch
48	M4-20-13	Bolt catch lever
49	P-31-C (2.5mmX13mm)	Bolt catch pin
50	OR (1mmX1mm)	O-ring for bolt catch pin
51	M4-20-14	Dust cover
52	S-L-83	Dust cover spring
53	M4-20-15	Dust cover detent housing
54	S-R-82	Dust cover detent spring
55	M4-20-16	Charging handle drive
56	SCR-CR-1 (M2X8mm cross)	Charging handle drive screw
57	M4-20-17	Dust cover rod
58	M4-20-18	Dust cover lock detent

No.	Code	Part name
59	M4-20-19	Dust cover rod snap ring
60	M4-20-20	Front pivot pin detent
61	S-R-81 (2mmX13mmX0.3mm)	Front pivot pin spring
62	M4-20-21	Takedown pin clip
63	P-30-C (3mmX26mm)	Gear box pin
64	KA-M4-16	M4 hop up assembly
65	M4-21-01 (2)	M4 handguard
66	M4-21-02 (2)	M4 handguard heat sink
67	SCR-CR-3 (4)	M4 handguard screws
68	FSP-14	Front sight
69	FSP-03	Front sight post
70	FSP-04	Front sight detent
71	S-R-04 (2.9mmX19mmX0.5mm)	Front sight detent spring
72	P-36-C (2)	Front sight taper pins
73	KA-SLA-14	Front sling swivel assembly
74		Gear box (Ver. 2) assembly
75		Hop up rubber
76		Inner barrel
77		Outer barrel
78		Outer barrel fasten screw
79	FH-13	Flash hider
80	FHP-15 & FHP-37	Flash hider washers
81	TG-06	Pistol grip
82	SCR-CR-1 (3mmX6mm cross)	Pistol grip screws
83		Motor
84		Motor spring
85	Stock P-28	6 position stock
86	Stock P-29	Lock-release lever
87	Stock P-30	Rear sling swivel
88	SCR-ST-2 (M5X10mm straight)	Rear sling swivel screw
89	Stock P-31	Rear sling swivel ring
90	Stock P-32	Lock-release lever pin
91	Stock P-08	Lock-release lever nut
92	SCR-HE-0 (M3X3mm)	Lock-release lever screw
93	S-R-16 (7.7mmX21.1mmX0.9mm)	Lock-release lever spring
94	M4-03	Stock ring for M4 collapsible stock
95	M4-05-01B	Stock pipe with marking
96	SCR-CR-3 (M5X80mm cross)	Stock pipe screw
97	M4-05-02	Stock pipe screw nut
98	M4-05-03	Stock pipe cover
99	SCR-HE-2	Stock pipe cover screw
100	M4-05-05	Castle nut
101	Stock P-33	battery case - left
102	Stock P-34	battery case - right
103	Stock P-35	Buttplate
104	Stock P-36	Access door hinge
105	Stock P-37	Access door detent
106	Stock P-38	Access door
107	Stock P-39	Buttcap spacer
108	Stock P-42	Buttstock
109	Stock P-43	Stock pipe
110	Stock P-30	Rear sling swivel
111	SCR-CR-3 (M5X80mm cross)	Stock pipe screw
112	S-R-17	Access door detent spring
113	P-23-0	Access door hinge pin
114	P-19-C	Access door pin
115	SCR-ST-2 (M5X30mm) (2)	Buttplate and rear sling swivel screws