



UNIVERSAL SNIPER AIRSOFT

King Arms

Please read through all instructions before operating this AEG

556 Series

SIG



Trademark of SAN,
used by permission of Cybergun.



WARNING

- User of this Air Electric Gun must be 18 years of age or older.
- The shooting range of the plastic BB bullet can reach up to 100 meters, beware at all time. Careless shooting may cause eye or other injuries.
- Read through this Handling and Instruction Manual carefully before operating this AEG.

<http://www.KingArms.com>

⚠️ WARNING ⚠️

Read through this Handling and Instruction Manual carefully before operating this AEG

This sport gun is developed for recreational use and it is capable to shoot BB bullets as a projectile so please be caution when handling or using this gun. Careless shooting or improper use is dangerous, and it can cause damage or injury on human or animal. Make sure you read through this manual and all the warnings before operating this gun.

Operating this airsoft gun must be aged over 18 years old. Careless shooting or improper operation are dangerous. Users must understand and follow the laws of country before possessing or operating this product.

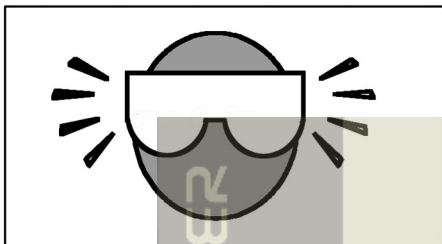

Always wear eyes protective gear.

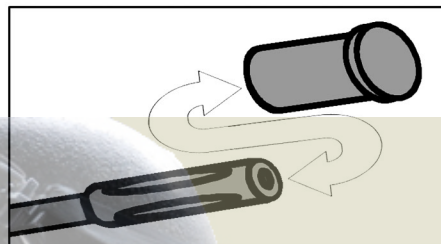

Always attach the protective plug to the gun muzzle.

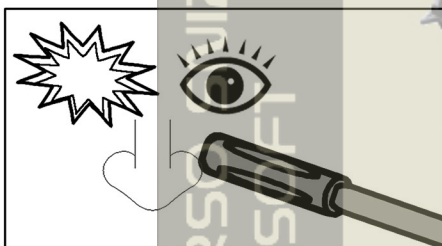

Never look into the gun muzzle.



Avoid pulling the trigger carelessly.

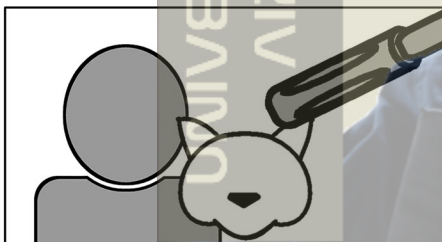

Never point or shoot the gun towards a person or an animal.



Always put the gun in a case or bag when you are carrying it.

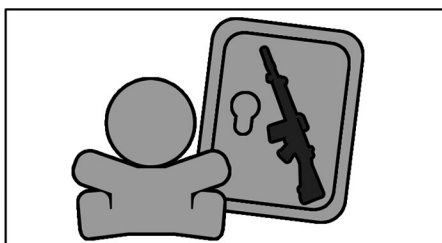

Store the air gun at places out of reach by children.

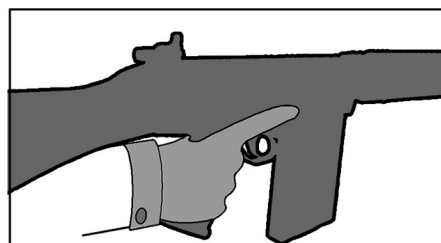

Always put your finger away from the trigger except when you are ready to fire the gun.

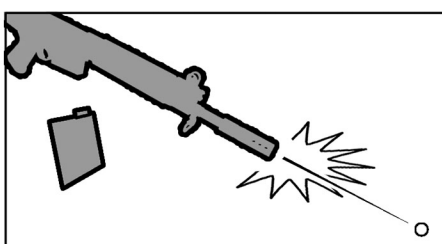

Even if the magazine is removed, there might be remaining BB bullet in the gun which still can be shooting.

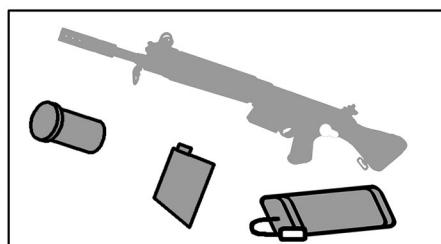

Always apply safety habits:
-Set selector lever at the Safety position.
-Attach the protective plug to the muzzle.
-Remove the magazine.
-Remove the battery from the AEG.

Caution

- Read through this manual before shooting. Pay special attention for safe operation.
- Remember the warnings and be cautions at all times
- Failing to do so may cause injury, accidents or damage to gun.

Charging the Battery

■ Charging the Battery. (Battery and charger sold separately)

Use the specified battery for the gun.
8.4V 1400mAh Battery.

Avoid use of non-standard battery or the original designed functions may not be working.

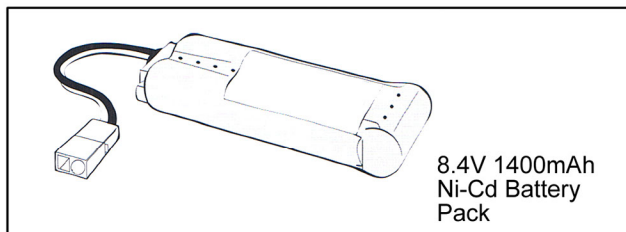

■ Use the specified battery charger which is applicable to the above battery.

Use only the correct battery and charger. We would not be held responsible for any accidents or damages caused by improper or incorrect operation, or usage of non-specified battery.

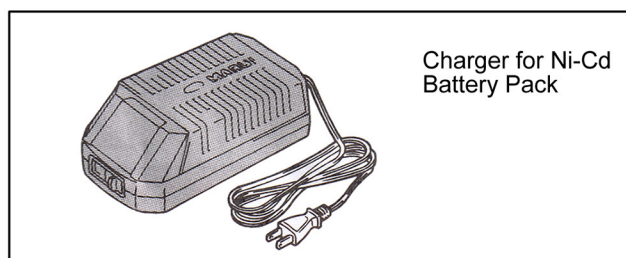

Component Names

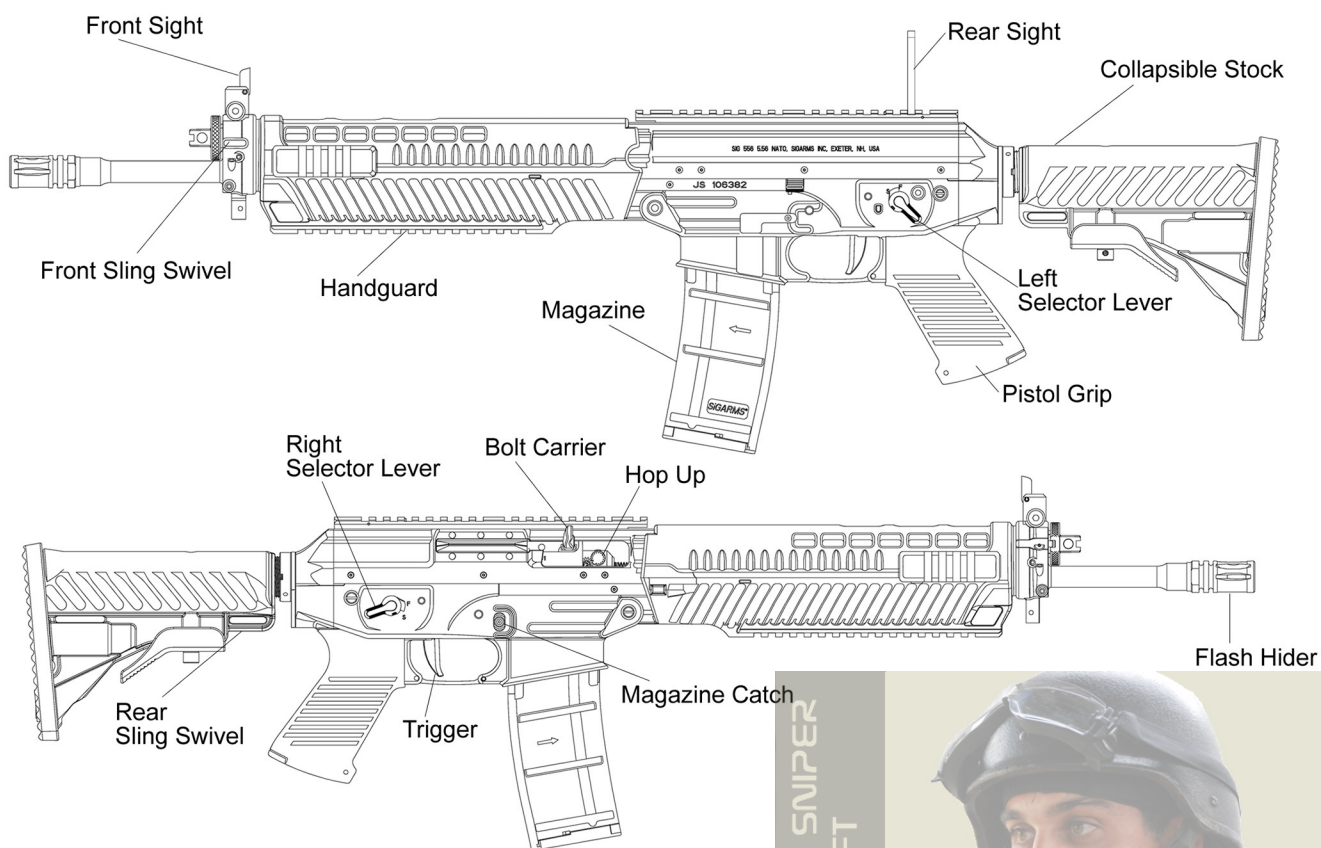

! Always attach the protective cap during storage.

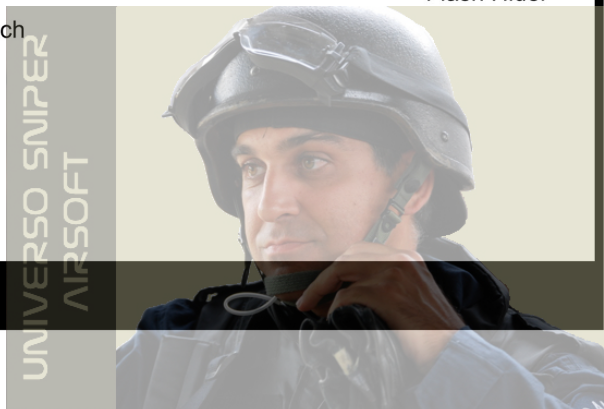

Selector Lever and Safety Setting

Warning

To prevent malfunction, please do not adjust the selector lever from semi to full auto while pulling the trigger.

Safety Setting

Always set the lever to the Safe position and attach the protective cap when you are not firing the gun or during storage.

Semi Auto (Single Shot)

The gun will fire one shot each time when the trigger is pulled.

Full Auto (Automatic Firing)

The gun will fire automatically while the trigger remains pulled.

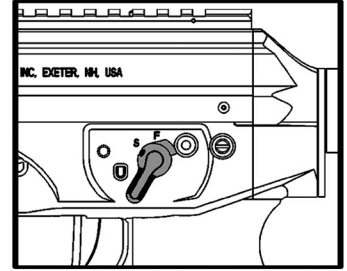
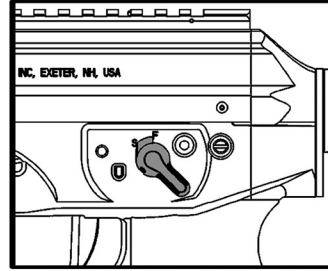
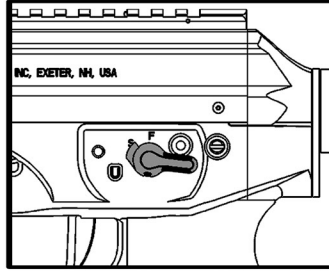
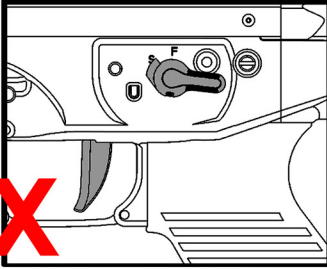

CAUTION: Set the selector lever correctly in position; otherwise, malfunction may occur.

Setting the Battery

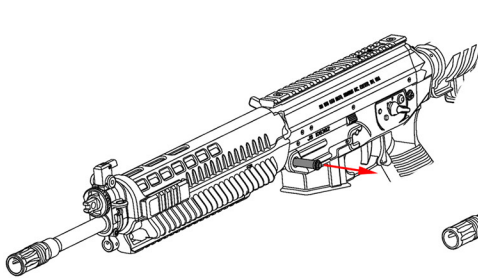

1. Pull the front receiver lock pin out.

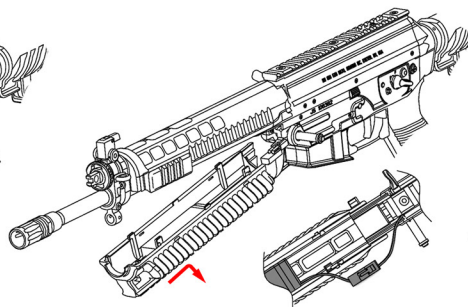

2. Release the the lower handguard by pulling it backward. Place the battery inside the lower handguard.

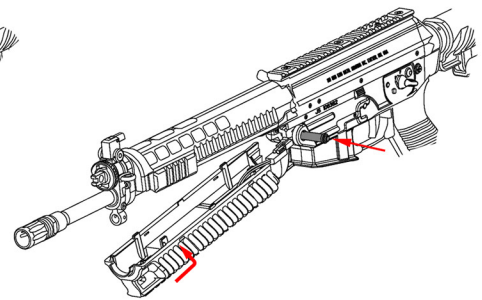

3. Install the lower handguard back and insert the receiver lock pin.

Movable Parts

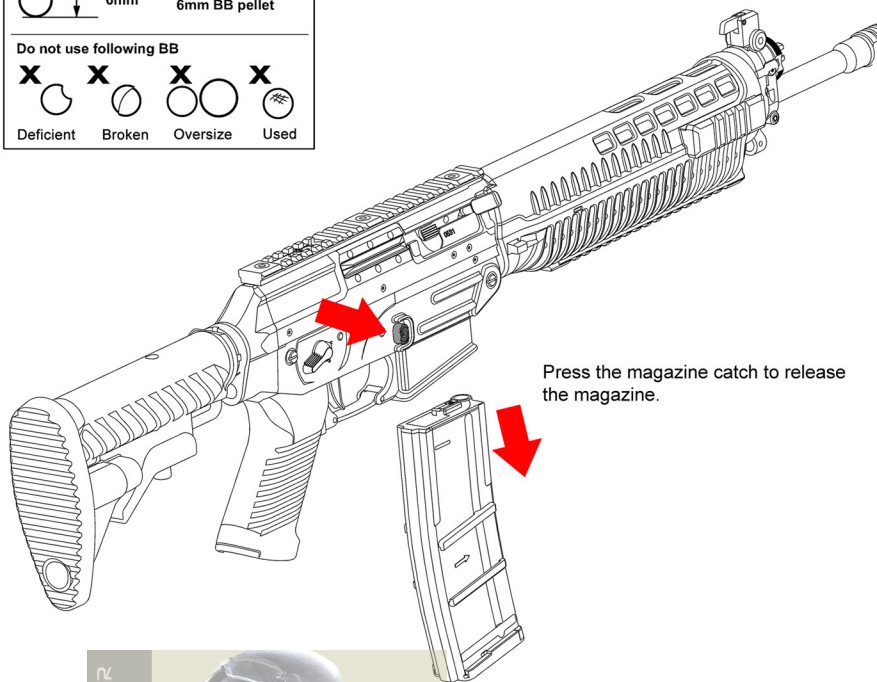
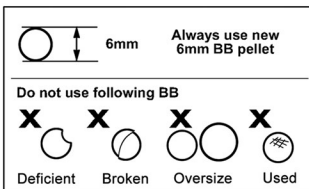

Inserting BB pellet

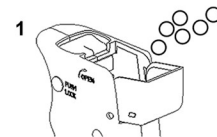

1 Lock the BB loader loading rod. Put up to 200 rounds of BB pellet in the loader.



2 Put the BB loader cap back on.

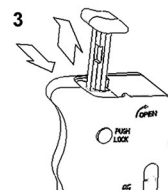

3 Unlock the loading rod.

4 Align the loader outlet with the magazine opening. Press loading rod to load BB into the magazine. Make sure loading rod is press and release completely.



UNIVERSO SNIPER
AIRSOFT

Bolt Carrier

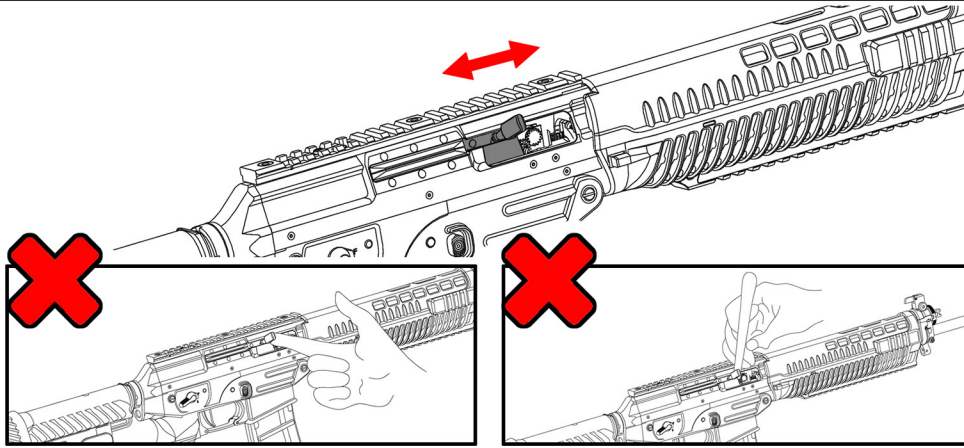

Do not touch the bolt carrier when AEG is connected to battery.

Do not interrupt the bolt carrier's operation.

⚠ WARNING ⚠

The bolt carrier action should not be interfered.

Do not try to stop the bolt carrier when it is operating, serious injury might occur if the bolt carrier is blocked.

Forcing bolt carrier to stop during operation will lead to gun malfunction.

Adjust Hop Up

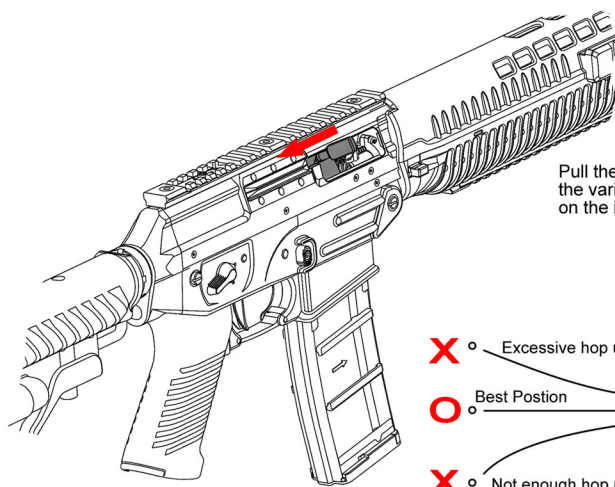

Pull the bolt handle backward, the variable hop-up could be seen on the inside of the ejection port.

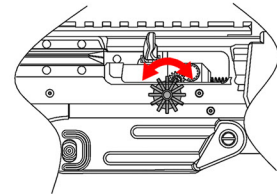

Excessive hop-up: turn the dial anti-clockwise.

Not enough hop-up: Gradually turn the dial clockwise.



- Turning the hop-up dial excessively can cause bullet clogging. Keep pulling the trigger while bullet being clogged will damage the piston and gears.
- If bullet clogging occurs, immediately stop firing the gun, return the hop dial to the Normal position and remove clogging bullets using a clearing rod (not included in this packing).
- Make sure to return the hop-up to normal position when removing clogged bullets. Otherwise, the chamber packing may be damaged.
- Never use used and dirty bullets. Dirty chamber will result in unstable hopping up.
- Lacking or over spraying of silicone oil will also lead the hopping up unstable.

Firing

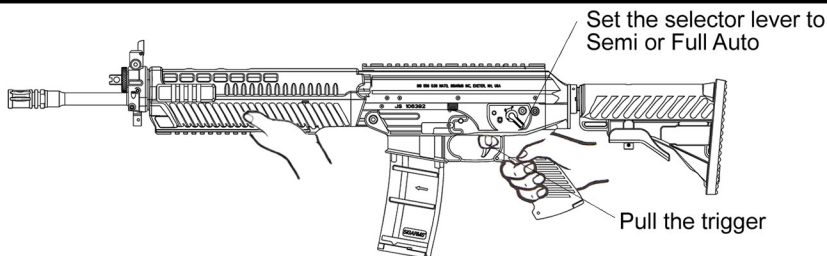

- Change the battery if the fire-rate becomes slow.
- It is normal that a blank fire may occur at the first shot even if the gun is loaded.
- There are possible cases which non-firing may occur after trigger is pulled in the semi-auto mode. To solve this issue, fire 5 to 10 bullets in the full auto mode first, and then switch back to semi-auto mode.
- It is normal that some smell may be generated from the motor for a while when a new gun is operating.
- It is normal that the hop-up function may be unstable for 200-300 bullets after silicone oil has been applied on hop up unit.

⚠ WARNING ⚠

make sure you followed all safety instructions before firing the gun.

remove the protective cap only when you are ready to fire.

after firing about 500 bullets, rest the gun for 5 to 10 minutes.

Always attach the protective cap and set the selector lever to Safety position when the air gun not ready to fire.



Removal of Boltback

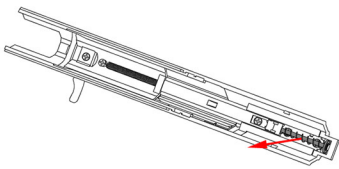

1. Pull the front receiver lock pin out. Take the lower receiver and front set apart from upper receiver.
Then pull the spring and spring guide out from upper receiver.

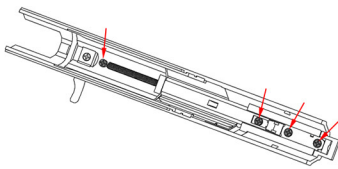

2. Loose 4 screws as the pic shown.

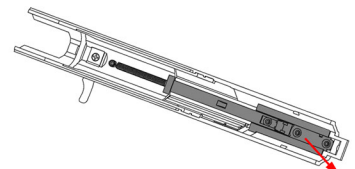

3. Take out the bolt assembly from upper receiver.

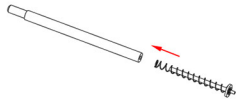

4. Put the front end of bolt spring and spring guide into part "SIG111" as shown.

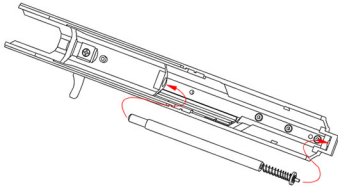

5. Place it inside the upper receiver.

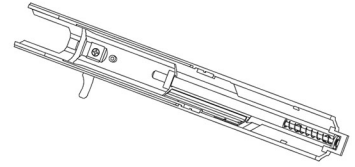

6. Put the front set and lower receiver back on.

Explosive Diagram

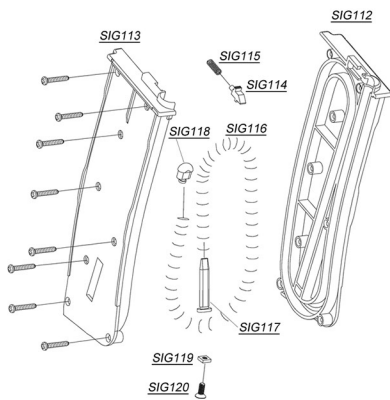

Instruction of blowback removed upper receiver

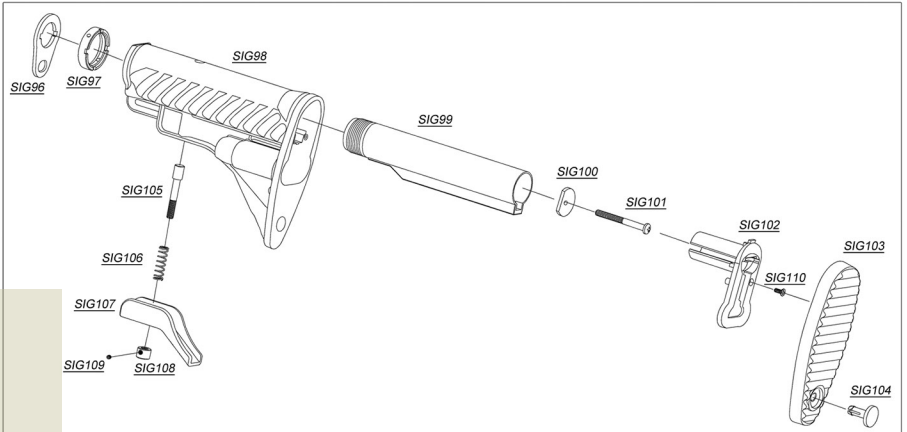
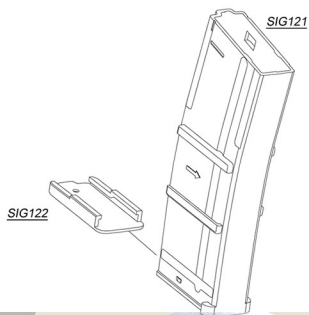
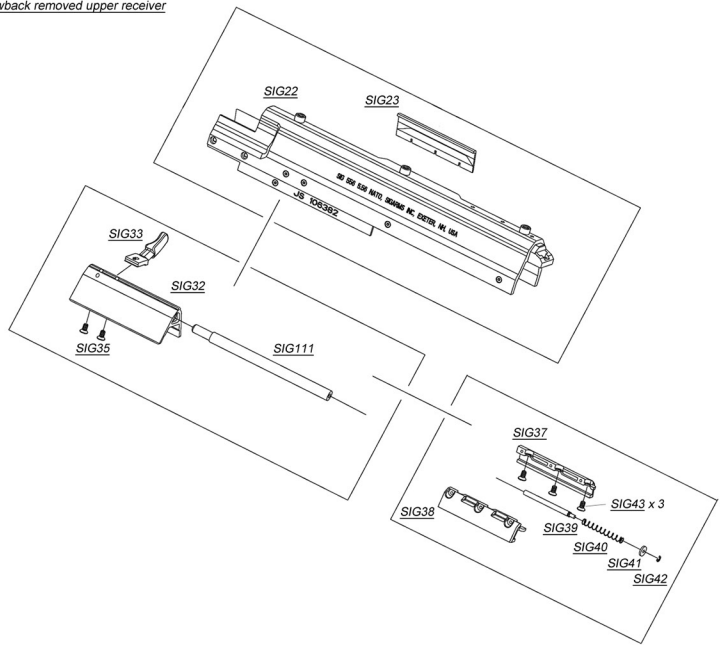

Explosive Diagram

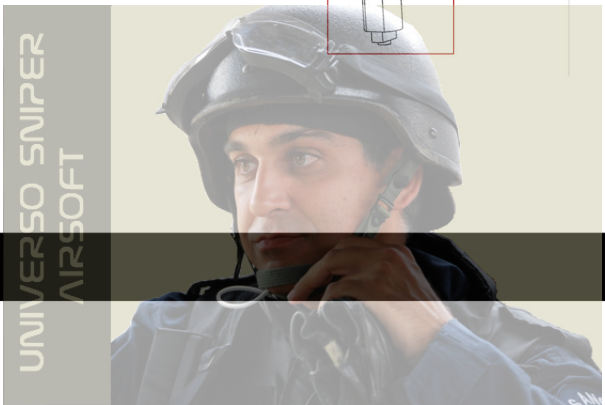
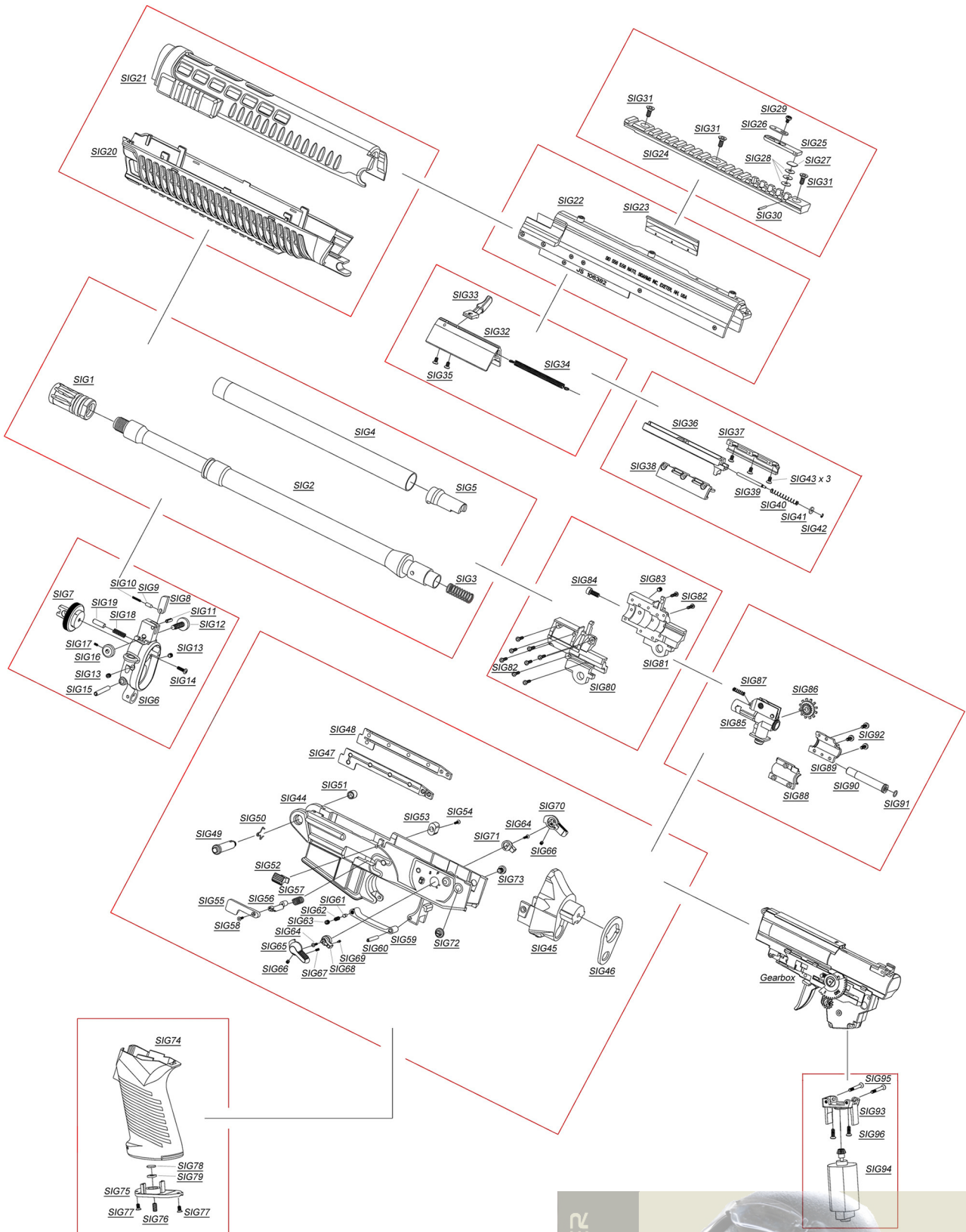

Thank you very much for buying King Arms product

Airsoft Gun Parts and Accessories Manufacturer



<http://www.KingArms.com>

