

Thompson Submachine Gun Series Instruction Manual

Please read through all instruction before operating the AEG rifle.



Thompson trade mark and trade dress are used under license of Saeilo Enterprises Inc. and its worldwide licensee Cybergun

⚠ WARNING

- User of this Air Electric Gun must be 18 years of age or older.
- The shooting range of the plastic BB bullet can reach up to 100 meters, beware at all time. Careless shooting may cause eye or other injuries.
- Read through this Handling and Instruction Manual carefully before operating this AEG.

⚠️ WARNING ⚠️

Read through this Handling and Instruction Manual carefully before operating this AEG

This sport gun is developed for recreational use and it is capable to shoot BB bullets as a projectile so please be caution when handling or using this gun. Careless shooting or improper use is dangerous, and it can cause damage or injury on human or animal. Make sure you read through this manual and all the warnings before operating this gun.

Operating this airsoft gun must be aged over 18 years old. Careless shooting or improper operation are dangerous. Users must understand and follow the laws of country before possessing or operating this product.

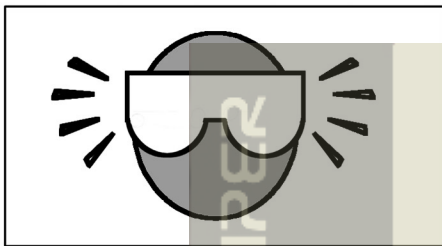

Always wear eyes protective gear.

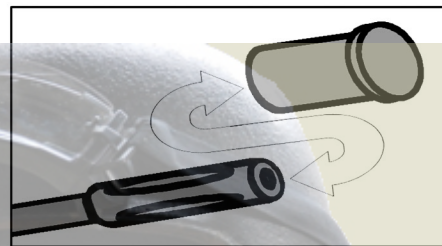

Always attach the protective plug to the gun muzzle.

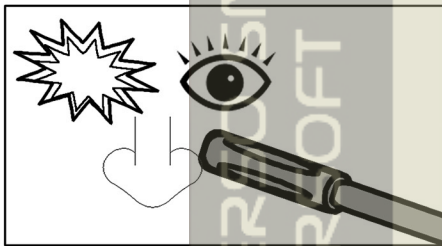

Never look into the gun muzzle.



Avoid pulling the trigger carelessly.

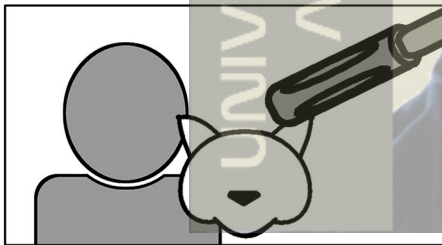

Never point or shoot the gun towards a person or an animal.

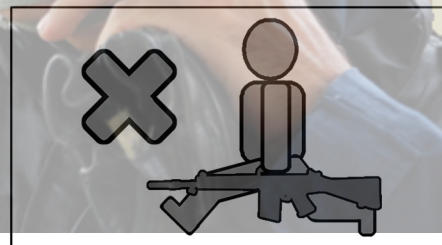

Always put the gun in a case or bag when you are carrying it.

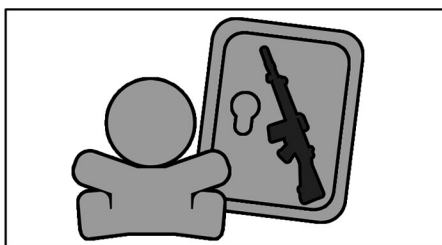

Store the air gun at places out of reach by children.

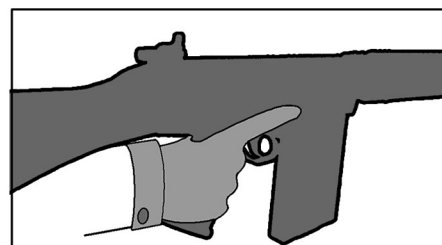

Always put your finger away from the trigger except when you are ready to fire the gun.

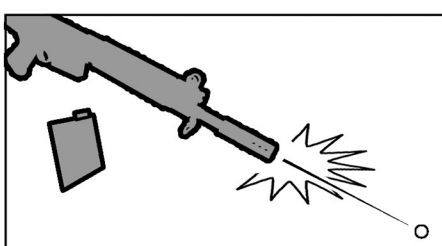

Even if the magazine is removed, there might be remaining BB bullet in the gun which still can be shooting.

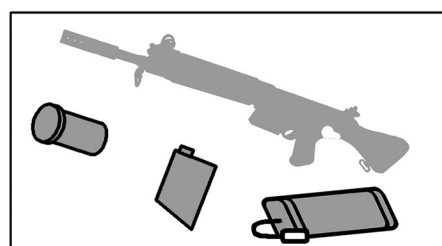

Always apply safety habits:
-Set selector lever at the Safety position.
-Attach the protective plug to the muzzle.
-Remove the magazine.
-Remove the battery from the AEG.

Caution

- Read through this manual before shooting. Pay special attention for safe operation.
- Remember the warnings and be cautions at all times
- Failing to do so may cause injury, accidents or damage to gun.

Charging The Battery

■ Charging the battery. (Battery and charger sold separately)

Use the specified battery for the gun.
8.4V Large Type Battery.

Avoid use of non-standard battery or the original designed functions may not be working.

■ Use the specified battery charger which is applicable to the above battery.

Use only the correct battery and charger. We would not be held responsible for any accidents or damages caused by improper or incorrect operation, or usage of non-specified battery.

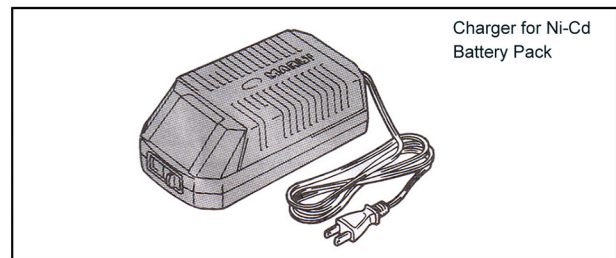
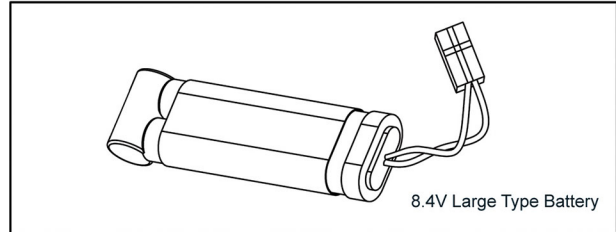

Component Names

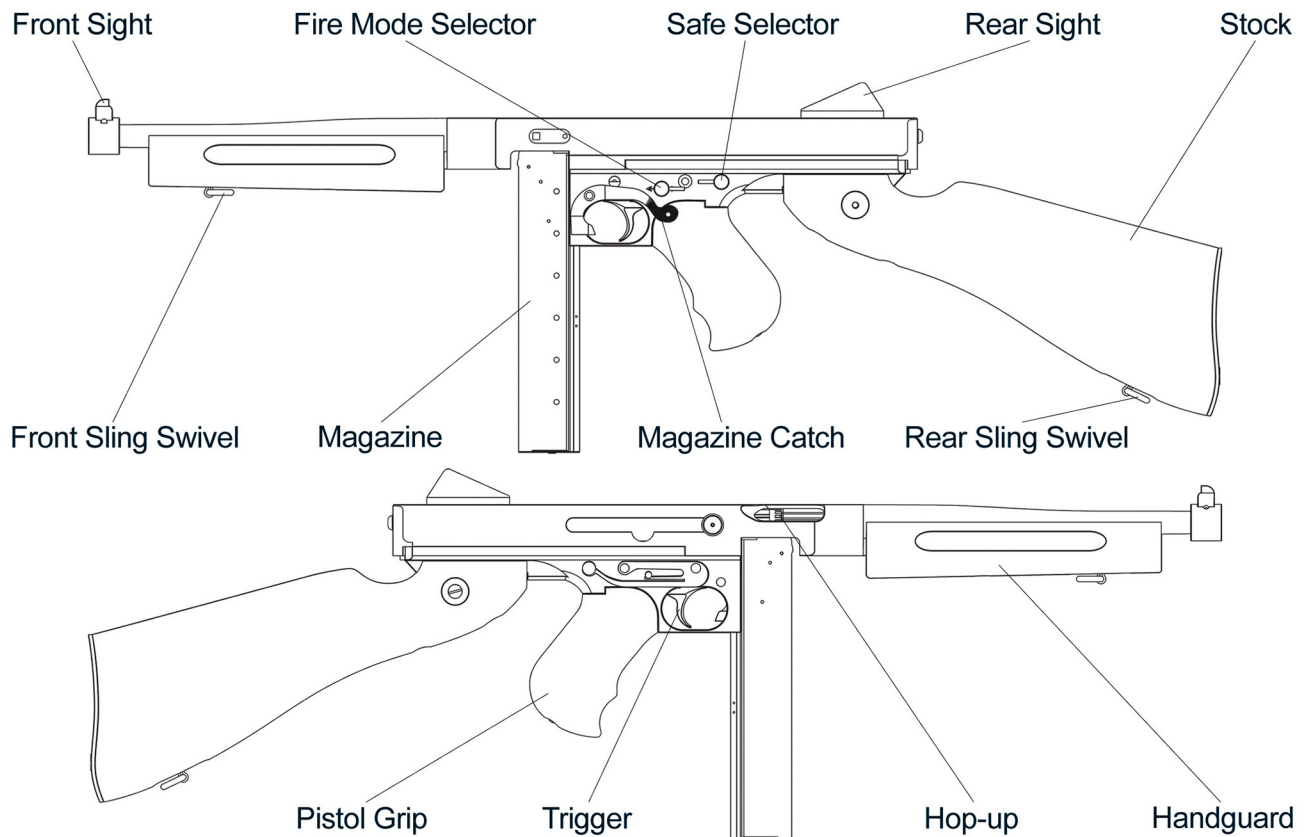

Selector Lever & Safety Setting

WARNING

To prevent malfunction, please do not adjust the selector lever from semi to full auto while pulling the trigger.

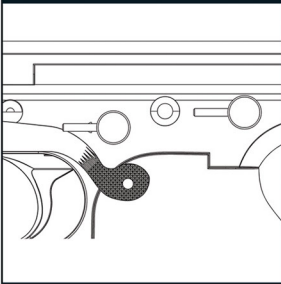

CAUTION: Set the selector lever correctly in position; otherwise, malfunction may occur.

Safety Setting

Always set the lever to the SAFE position and attach the protective cap when you are not firing the gun or during storage.

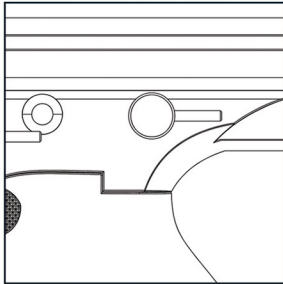

Semi Auto (Single Shot)

The gun will fire one shot each time when the trigger is pulled.

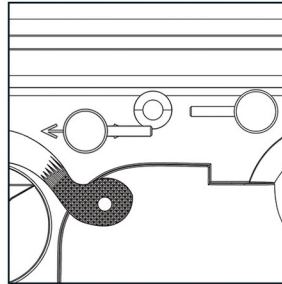

Full Auto (Automatic Firing)

The gun will fire automatically while the trigger remains pulled.

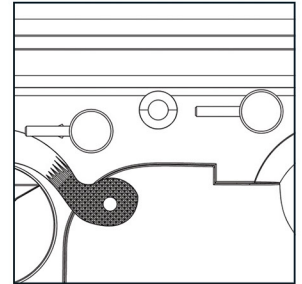

Installing The Battery

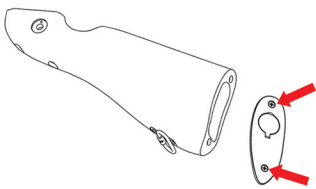

1. Release the stock butt plate out by loosen the 2 screws.

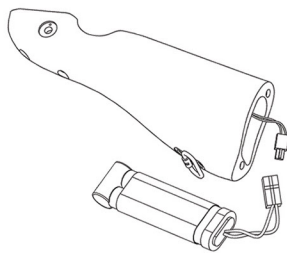

2. Insert the battery into stock.

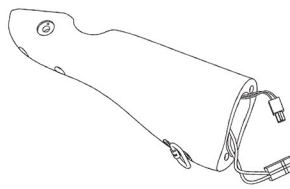

3. Connect the plugs and place the wires inside the stock.

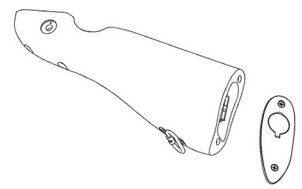

4. Put the stock butt plate back on the stock, fix it by 2 screws.

Setting The Magazine

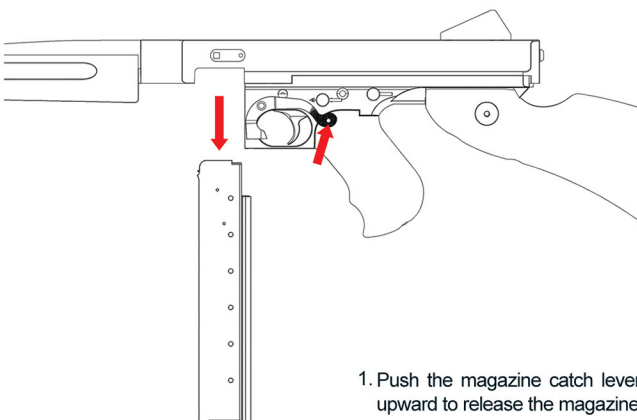

1. Push the magazine catch lever upward to release the magazine.

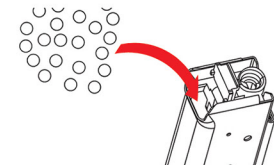
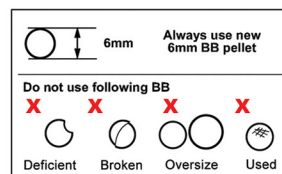

2. Open the cover on top of the magazine. Put BBs into the magazine and close the cover

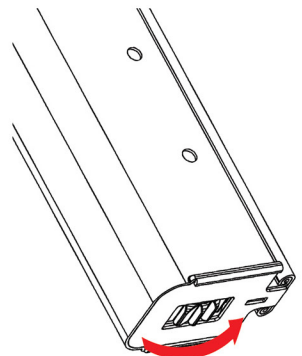

3. Turn the dial on the bottom of the magazine to wind up the magazine.



UNIVERSO SNIPER AIRSOFT

Firing The Rifle

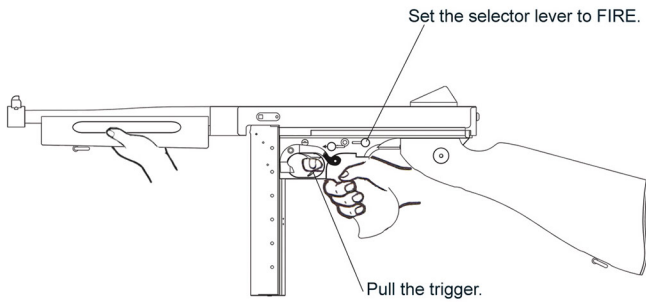

⚠ WARNING ⚠

- Make sure you followed all safety instructions before firing the gun.
- Remove the protective cap only when you are ready to fire.
- After firing about 500 bullets, rest the gun for 5 to 10 minutes.
- Always attach the protective cap and set the selector lever to Safety position when the air gun not ready to fire.

- Change the battery if the fire-rate becomes slow.
- It is normal that a blank fire may occur at the first shot even if the gun is loaded.
- There are possible cases which non-firing may occur after trigger is pulled in the semi-auto mode. To solve this issue, fire 5 to 10 bullets in the full auto mode first, and then switch back to semi-auto mode.
- It is normal that some smell may be generated from the motor for a while when a new gun is operating.
- It is normal that the hop-up function may be unstable for 200-300 bullets after silicone oil has been applied on hop up unit.

Adjusting The Hop Up

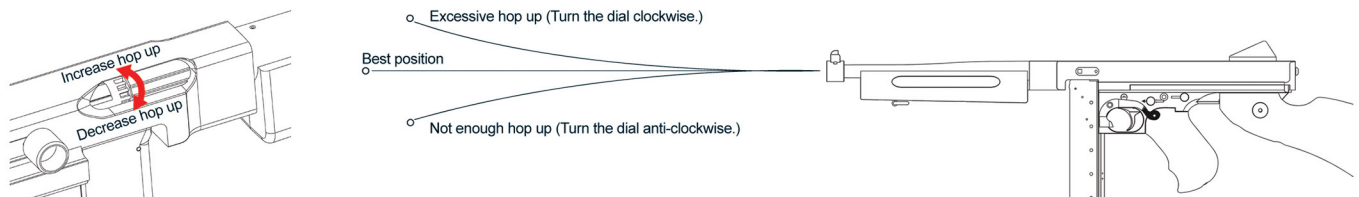

- Turning the hop-up dial excessively can cause bullet clogging. Keep pulling the trigger while bullet being clogged will damage the piston and gears.
- If bullet clogging occurs, immediately stop firing the gun, return the hop dial to the Normal position and remove clogging bullets using a clearing rod (not included in this packing).
- Make sure to return the hop-up to normal position when removing clogged bullets. Otherwise, the chamber packing may be damaged.
- Never use used and dirty bullets. Dirty chamber will result in unstable hop up.
- Lacking or over spraying of silicone oil will also lead to unstable hop up.

Adjusting The Rear Sight

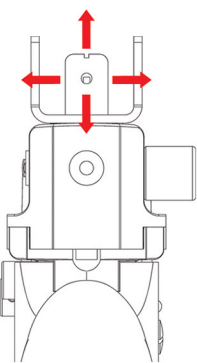

UNIVERSO SNIPER
AIRSOFT



Explosive Diagram Thompson M1A1 Real Wood Version.

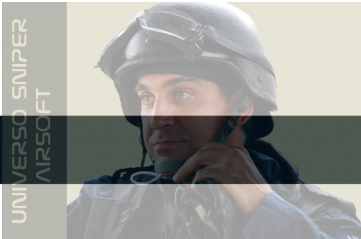
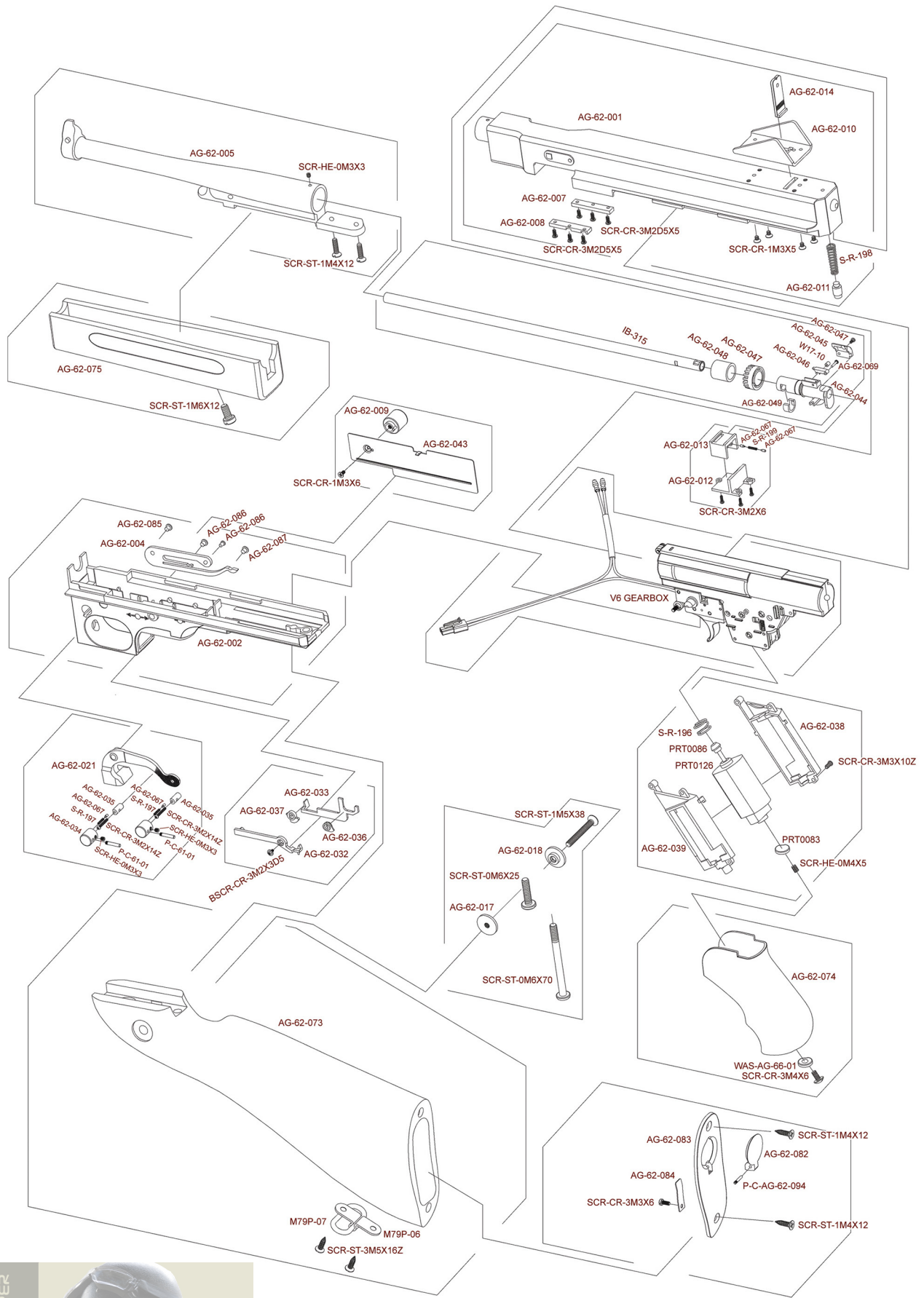

UNIVERSO SNIPER
AIRSOFT

Thank you very much for buying King Arms product

Airsoft Gun Parts and Accessories Manufacturer



<http://www.KingArms.com>

