

UNIVERSO SNIPER  
AIRSOFT

King Arms

# VSS Vintorez Instruction Manual



## ⚠ WARNING

- User of this airsoft rifle must be 18 years of age or older.
- The shooting range of the plastic BB bullet can reach up to 100 meters, beware at all time. Careless shooting may cause eye or other injuries.
- Read through this Handling and Instruction Manual carefully before operating this gun.

# WARNING

Please read through this Manual carefully before operating this gun.

This sport gun is developed for recreational use and it is capable to shoot BB bullets as a projectile so please be caution when handling or using this gun. Please pay special attention for safe operation and remember the warnings and be cautions at all times. Careless shooting or improper use is dangerous, and it can cause damage or injury on human or animal.

Operating this sport gun must be aged over 18 years old. Users must understand and follow the laws of country before possessing or operating this product.

Always wear eyes protective gear.

NEVER look into the gun muzzle.

NEVER point the gun or to shoot towards a person or an animal.

Store the airsoft gun at places out of reach by children.

Always put the gun in a case or bag when you are carrying it.

Always put your finger away from the trigger except you are ready to fire the gun.

Set selector lever at the "SAFE" position, and remove the magazine when the rifle is not in use.

Even if the magazine is removed, there might be remaining BB bullet in the gun which still can be shooting.

Use only the designated battery charger to charge battery.  
Do NOT use battery which is swell-up or damaged.  
Do NOT expose battery to water or fire.  
Do NOT drop, throw or bend the battery.  
Do NOT expose the battery to extreme high or low temperatures.



UNIVERSO SNIPER  
AIRSOFT





## Component Names

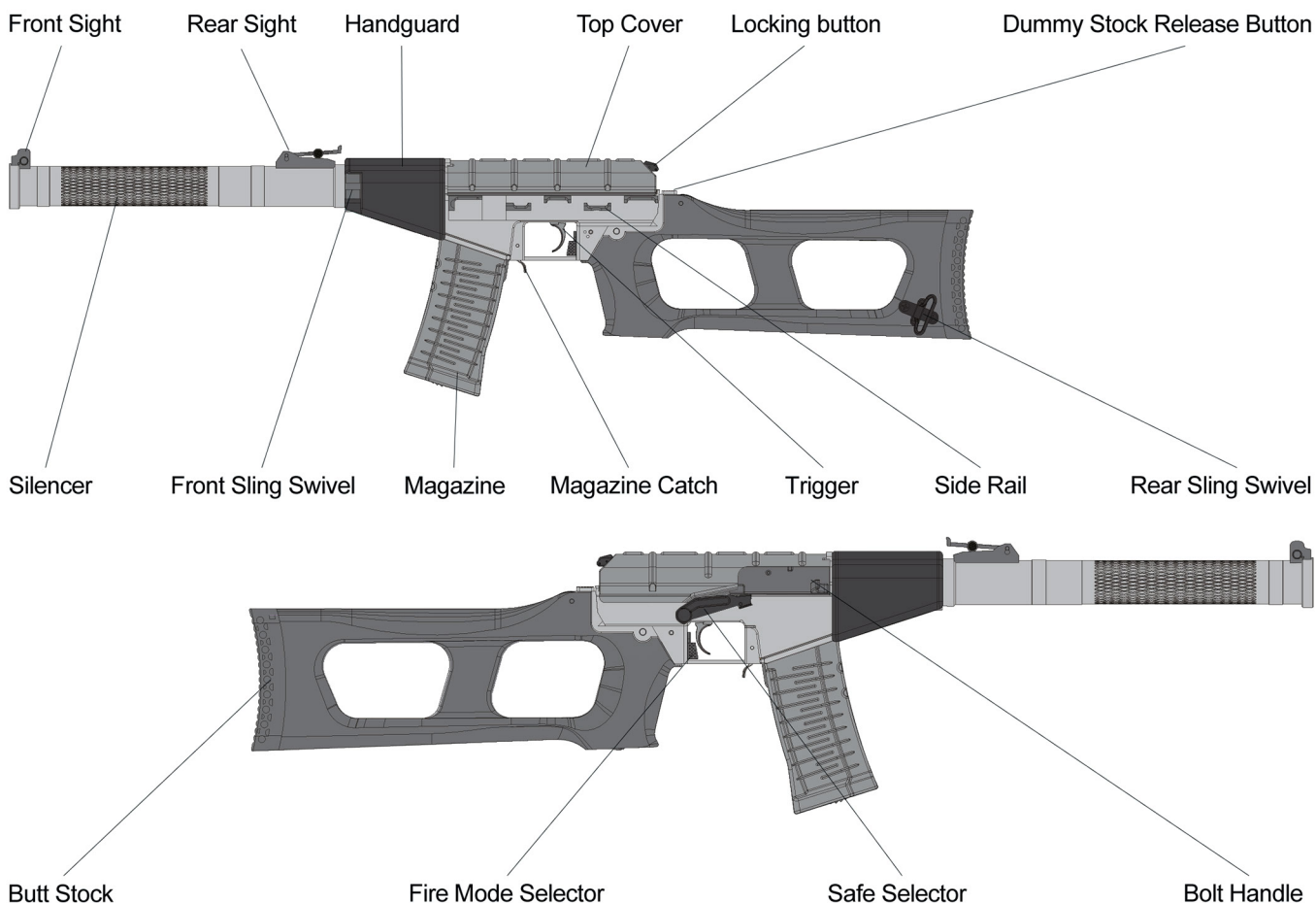

## Charging The Battery

- Charge the battery every time before operating the gun. (Battery and charger sold separately except Field Package)
- Always treat your battery with care, do not attempt to disassemble or modify the battery or alter the cord or plug.
- Use the specified battery for the gun and avoiding use of non-standard battery or the original designed functions may not be working.
- Make sure the battery is in good shape before charging. Use the specified battery charger which is applicable to the above battery. Never charge the battery if it is damaged and stop charging when battery is overheat.
- Only use the correct battery and charger. King Arms would not responsible and liable for any accidents, losses or damages whatsoever caused by improper or incorrect usage of battery.

## Installing The Battery

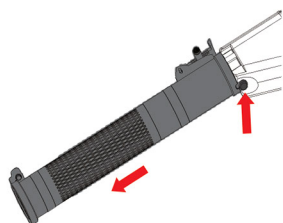

Press the button indicated by arrow then separate the silencer from the rifle in the direction as the arrow shown.

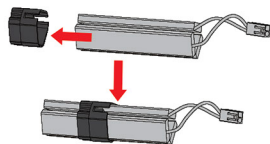

Slide the battery into the triangle battery holder.

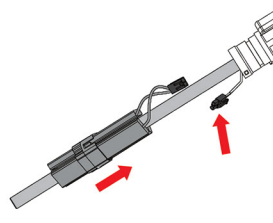

Slide the battery with holder over the outer barrel then connect the plugs.

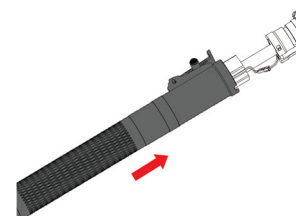

Make sure the wiring is stayed inside the silencer and place it back to the original place.

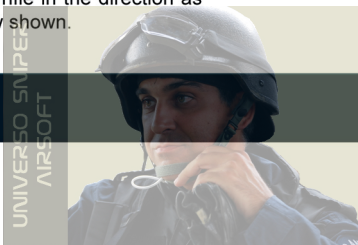

## Selector Lever & Safety Setting

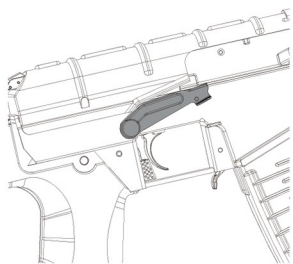

### Safety On

Trigger cannot be pulled. Always set the lever to the SAFE position and attach the protective cap when you are not firing the gun or during storage.

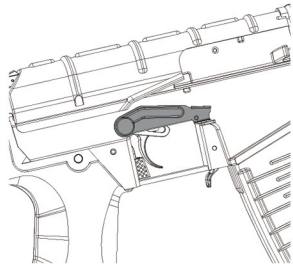

### Safety Off

Trigger can be pulled and the rifle is ready to fire.

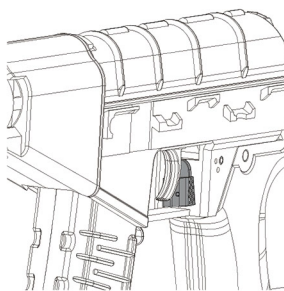

### Semi Auto (Single Shot)

The gun will fire one shot each time when the trigger is pulled.

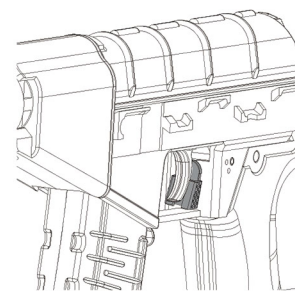

### Full Auto (Automatic Firing)

The gun will fire automatically while the trigger remains pulled.

## Loading The Magazine

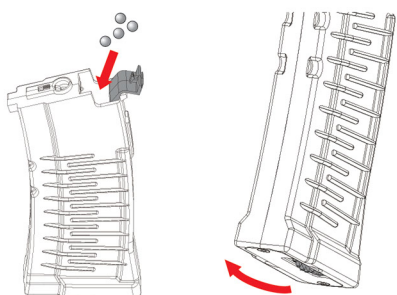

### For high capacity magazine:

Open the cover of the magazine and insert the BBs into it then close the cover until it is full. Then wind up the magazine in the direction as the arrow shown.

Always use new BB bullets or jamming and damage of rifle may occurs.  6mm

Do not use the following BBs:



• Remove the magazine from the rifle and make sure there is no bullet remains in the chamber when the rifle is not in use.

• Please beware that the maximum loading capacity for the King Arms VSS Vintorez Hi-cap Magazine is 380 rounds of 6mm BB. Do not overfeeding the magazine or it will damage the magazine and the rifle.

• If the magazine is overloaded, it may not be able to insert it into the rifle, and might even cause damage to the gun. Do not overfeed the magazine and keep in under the maximum loading capacity, which is 380 rounds. (Even there might be still room to insert more than 380 BBs in the magazine, it is not recommended for user to do so and King Arms shall not be held responsible for related damages.)

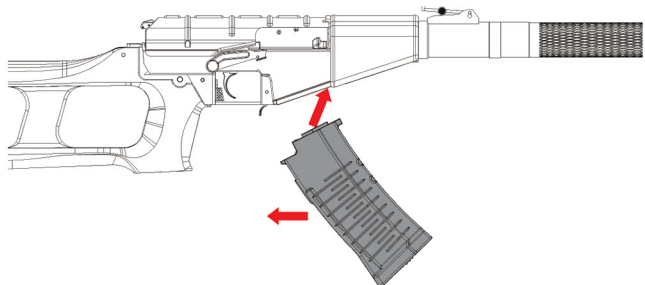

Insert the lug on front of the magazine into the magwell slot, then pull the magazine towards trigger until it snaps into place.

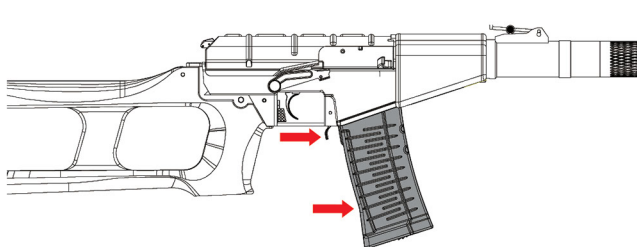

Remove the magazine by pressing the magazine catch towards the magazine, then swing the magazine forwards out of the receiver.

## Sight Adjustment

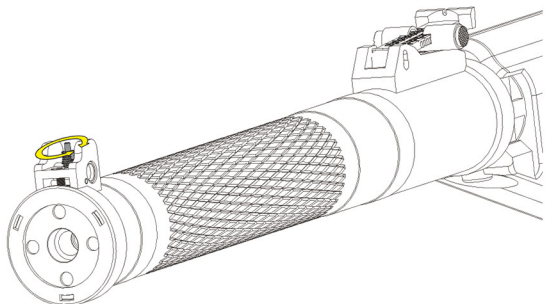

Adjust the front sight by rotating it.

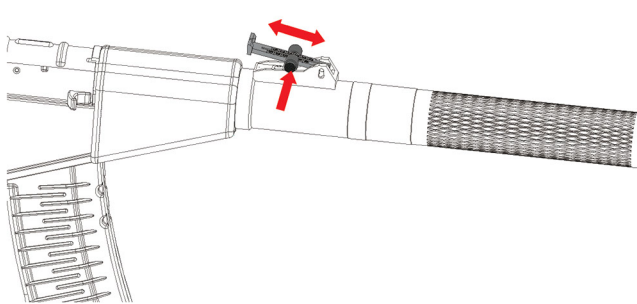

Set the rear sight for desired elevation by pressing the button and move the indicator forwards and backwards along the slide bar.

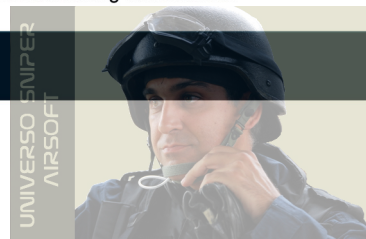



## Firing The Rifles

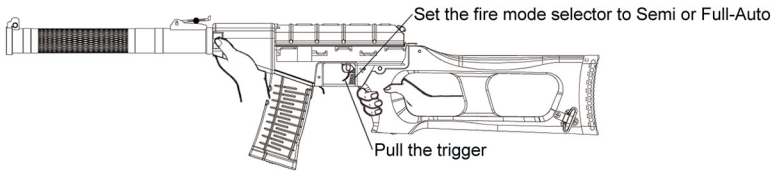

### ⚠ WARNING ⚠

- Make sure you followed all safety instructions before firing the gun.
- Remove the protective cap only when you are ready to fire.
- After firing about 500 bullets, rest the gun for 5 to 10 minutes.
- Always attach the protective cap and set the selector lever to Safety position when the air gun not ready to fire.

- Change the battery if the fire-rate becomes slow.
- It is normal that a blank fire may occur at the first shot even if the gun is loaded.
- It is normal that some smell may be generated from the motor for a while when a new gun is operating.
- It is normal that the hop-up function may be unstable for the first couple rounds after silicone oil has been applied on hop-up unit.
- It may be possible that the trigger cannot be pulled in "Semi" mode as the cut-off lever inside the gearbox is activated, user can fire 1-3 seconds in "Auto" mode to solve this problem.

## Hop-up Adjustment

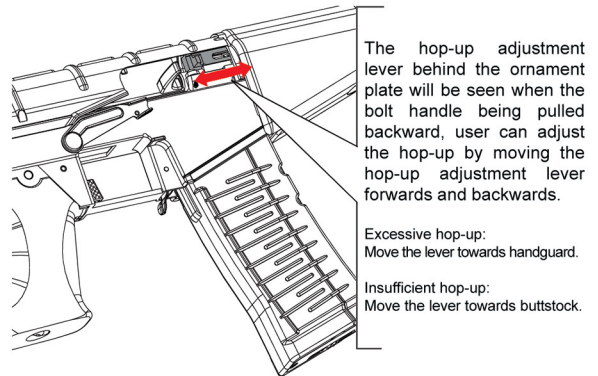
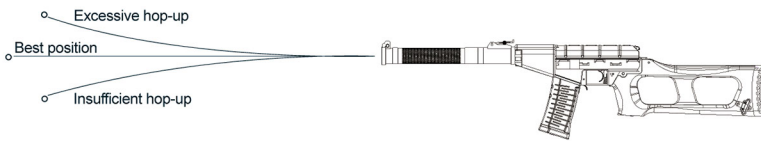

- Moving the hop-up adjustment lever excessively can cause bullet clogging. Keep pulling the trigger while bullet being clogged will damage the gun.
- Stop firing the gun immediately if bullet clogging occurs. Move the hop-up adjustment lever to the "Normal" position and remove the clogging bullets using a clearing rod.
- Make sure to move the hop-up adjustment lever to the "Normal" position while removing the clogged bullets, otherwise the chamber unit may be damaged.
- Never use dirty or used bullets as dirty chamber will result in unstable hop up.
- Lacking or over spraying of silicone oil will also lead to unstable hop up.

## Maintenance

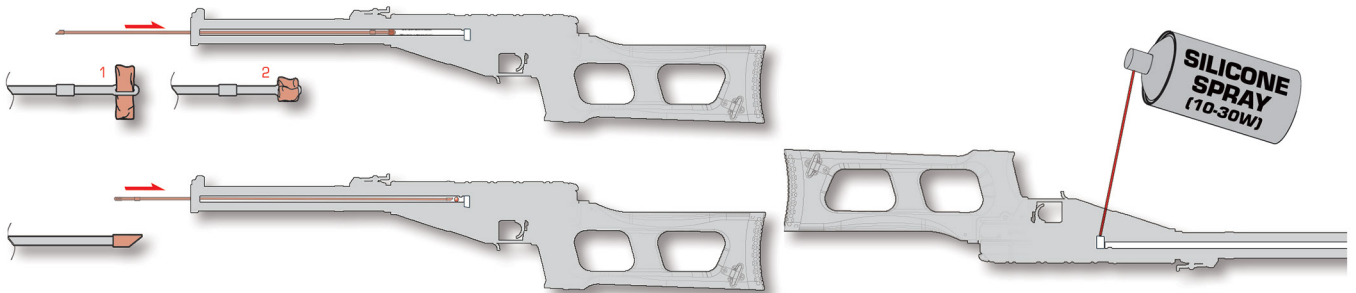

### Cleaning rod usage:

User can use a cleaning rod to clean the inner barrel, there is a hole on one end and user can place a piece of cleaning cloth and slide it in the inner barrel to clean the barrel. On the other end, there is a plastic tip for user to push the jammed BB out from the inner barrel.

### Silicone spray:

Apply some silicone oil onto moving parts and also into the BBs feeding tube (where the BBs are fed up into the hop-up unit). Be noticed that do not use WD40 or real gun oil since they might be corrosive and cause damage to the parts of your gun.

### Gearbox spring tension releasing:

After the shooting process, the piston inside the gearbox might not be able to finish the entire shooting cycle and will be stopped in the middle. This will cause the spring to constantly being compressed and hence the shooting power will be decrease in long run. Therefore, to ensure the piston to finish the entire shooting cycle and able to release the spring tension is important for the gearbox to be maintain in its best working condition. The easiest way to avoid this issue is to dry-fire 3-5 shots in semi-auto to let the piston to complete its cycle.

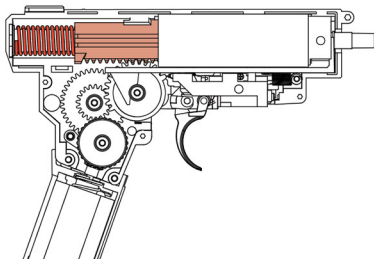

In this situation, the piston is stopped in the middle of the shooting cycle. The spring is now being compressed and it will cause damage to the spring in long run.

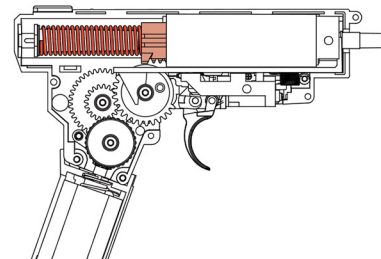

After dry-firing 3-5 shots in semi-auto mode, the piston will complete the shooting cycle and going back to the original position therefore the spring is not being compressed.



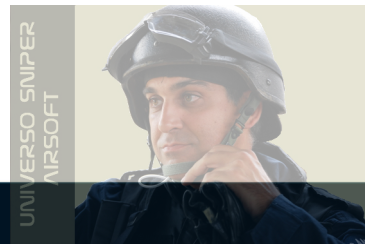
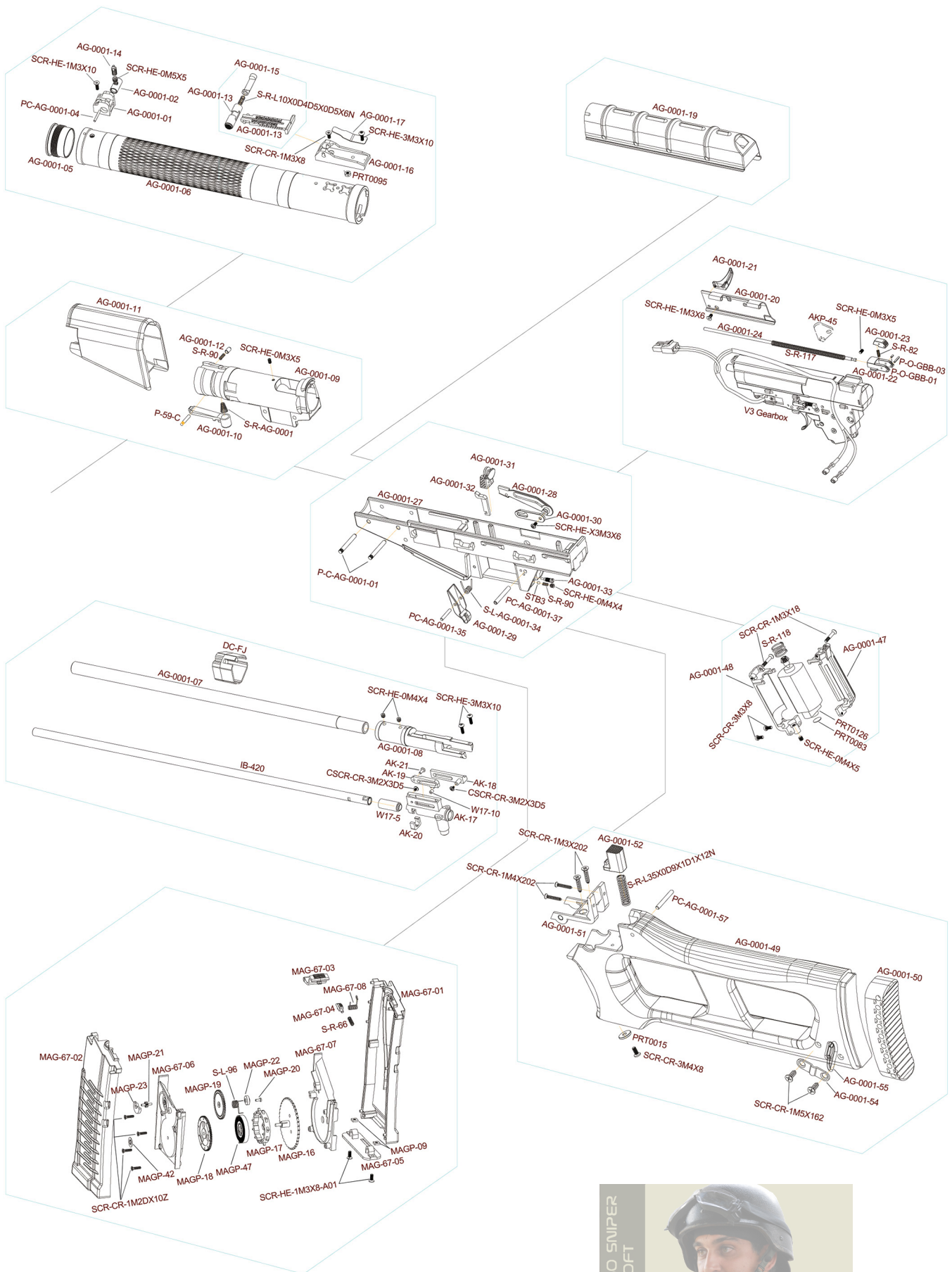

UNIVERSO SNIPER  
AIRSOFT

Thank you very much for buying King Arms product.

Airsoft Gun, Parts and Accessories Manufacturer



[www.KingArms.com](http://www.KingArms.com)

UNIVERSO SNIPER  
AIRSOFT



MUAL-995-A02