

# SAFETY GUIDELINES



*Read through the following safety guidelines and warnings in this manual to ensure safe handling and operation of the airsoft gun. Failure to do so may lead to injury or other serious bodily harm, as well as legal liability and potential damage to the product.*

## **ONLY POINT THE MUZZLE AT THE INTENDED TARGET**

Practicing good muzzle control will prevent others from being injured and lower the amount of friendly-fire.

## **KEEP THE AIRSOFT GUN UNLOADED WHEN NOT IN USE**

Wait until you are on the field and everyone has eye pro on before loading your gun. When you leave the field (even just to go grab something from the staging area), eject the magazine and fire several shots at the ground to clear the gun. Perform regular maintenance on your airgun to make sure that it remains safe for use.

## **BE SURE OF YOUR TARGET AND BEYOND**

To minimize the potential for unexpected injury, always be aware of what is behind, beyond and either side of your target before you fire your gun at your target.

## **USE HIGH QUALITY AMMUNITION**

Cheap BBs have been known to shatter on impact, resulting in plastic shrapnel flying in all directions. Using quality BBs is safer for you, your teammates, and your gun.

## **IF YOUR GUN FAILS TO FIRE, TAKE PRECAUTIONS**

If your airsoft gun fails to function as it should and you can't correct the issue in-game, unload the mag, try to clear the gun (or unplug the battery), and use a secondary weapon. If you do not have a secondary, you can still support your team by being a spotter and doing recon. After the game, unplug the battery and attempt repairs in a safe environment.

## **ALWAYS WEAR EYE AND FACE PROTECTION**

You must make sure that both you and those around you are wearing protective, shatterproof goggles, but ideally have full-face masks on. This way, your ears, cheeks, teeth, and eyes are all protected at the same time. You should also be sure to wear thick clothing in case you accidentally get hit, to minimize physical damage.

## **CLEAR AND CLEAN YOUR AIRSOFT BARREL**

After each scenario at a game, clear your airsoft gun by firing at the ground a few times with the mag out to clear any BBs still in the hop-up. When you get home, clean the inner barrel to prevent jams and increase accuracy.

## **DON'T RELY SOLELY ON THE "SAFETY"**

A safety is a mechanical device, not a substitute for common sense and good safety procedures. Always treat your airsoft gun as if it is loaded and ready to fire.

## **DO NOT ALTER AIRSOFT GUNS WITHOUT TECH EXPERIENCE**

If you try to upgrade your airsoft gun without proper experience, you not only risk breaking the gun, you also may make it a part-spewing, overpowered death machine (that was not meant to sound cool in any way). Spend the time to learn how to upgrade airsoft guns properly and talk to professional airsoft techs to figure out what the best upgrades are.

## **LEARN HOW AIRSOFT GUNS WORK AND WHY**

Learning how airsoft guns work allows you to understand the reason things go wrong with your gun, and direct you to make informed decisions about upgrading. It will also keep you safer on the field because you will have the knowledge to correct issues and prevent them in the future.



## ABOUT LANCER TACTICAL

Established in 2012 to bring high performance airsoft products with innovations that are designed for all players, for casual or professional play. Lancer Tactical promotes affordability without sacrificing reliability and durability, thus allowing entry-level players into this sport at a reasonable price, as well as offering premium grade products for advanced players. Our airsoft product line ranges from AEG upgrade parts to tactical gear, covering all your airsoft needs. Lancer Tactical is here to set you to win!

## INTRODUCING THE GEN 3 SERIES

Lancer Tactical's newest innovation offers many similar internals to the Proline series AEGs, with a few new features and upgraded parts.

The Gen 3 AEG is built with a high-strength full-polymer construction that is very lightweight, yet extremely durable. It uses a new built-in Zion Arms fully-programmable electronic trigger unit that can be programmed to shoot in varying burst modes. Paired with the Lancer fast trigger, the Gen 3 are going to be shooting a barrage of BBs down range.

Unlike the previous generation, the Gen 3 series are now equipped with a deans connector that saves more space for high capacity batteries. Now shooting at around 380 - 400 FPS right out of the box, but also includes a low FPS spring for the users to be able to switch their springs on the fly with Lancer Tactical's quick change spring system (accessed through the buffer tube).

Also featuring a reinforced metal Gen-2 gearbox with ultra-smooth 8mm ball bearings, 18:1 steel gears set, steel teeth polycarbonate piston, bearing spring guide, rotary hop-up, 19,000 RPM high torque motor for consistent performance. The polished 6.03mm tightbore inner barrel improves range and accuracy. Full length 20mm picatinny top rail that allows users to mount optics, lights, lasers, and PEQ boxes. The functional dust cover opens up by pulling the charging handle back to reveal a rotary-style hop-up that can be easily adjusted on the fly. This gun comes with a newly designed 140-round high-speed polymer magazine that can feed BBs up to 30 RPS.

## OVERVIEW

<b>FPS:</b>	380-400 (330-350 Extra-Low FPS Spring)
<b>RPS:</b>	22-25
<b>Magazine:</b>	140rd Mid-Cap High Speed
<b>Spring:</b>	Quick-Change M120
<b>Motor:</b>	High-Torque 19K RPM
<b>Material:</b>	Polymer Handguard and Receivers, Metal Buffer Tube
<b>Battery Connector:</b>	DEANS
<b>Features:</b>	Built-in NEBULA programmable electric trigger unit, Fast Trigger, Ball Bearing Spring Guide, Steel Piston Teeth, 18:1 Gear Set, 8mm Ball Bearing, 6.03 Inner Barrel
<b>In the Package:</b>	Rifle x1, Magazine x1, Extra Low FPS Spring x1, Clean Rod x1, BB x1, Patch x1 (Some packages may include more items) <b>NOTE: BATTERY AND CHARGER SOLD SEPARATELY</b>

# LINE DRAWINGS

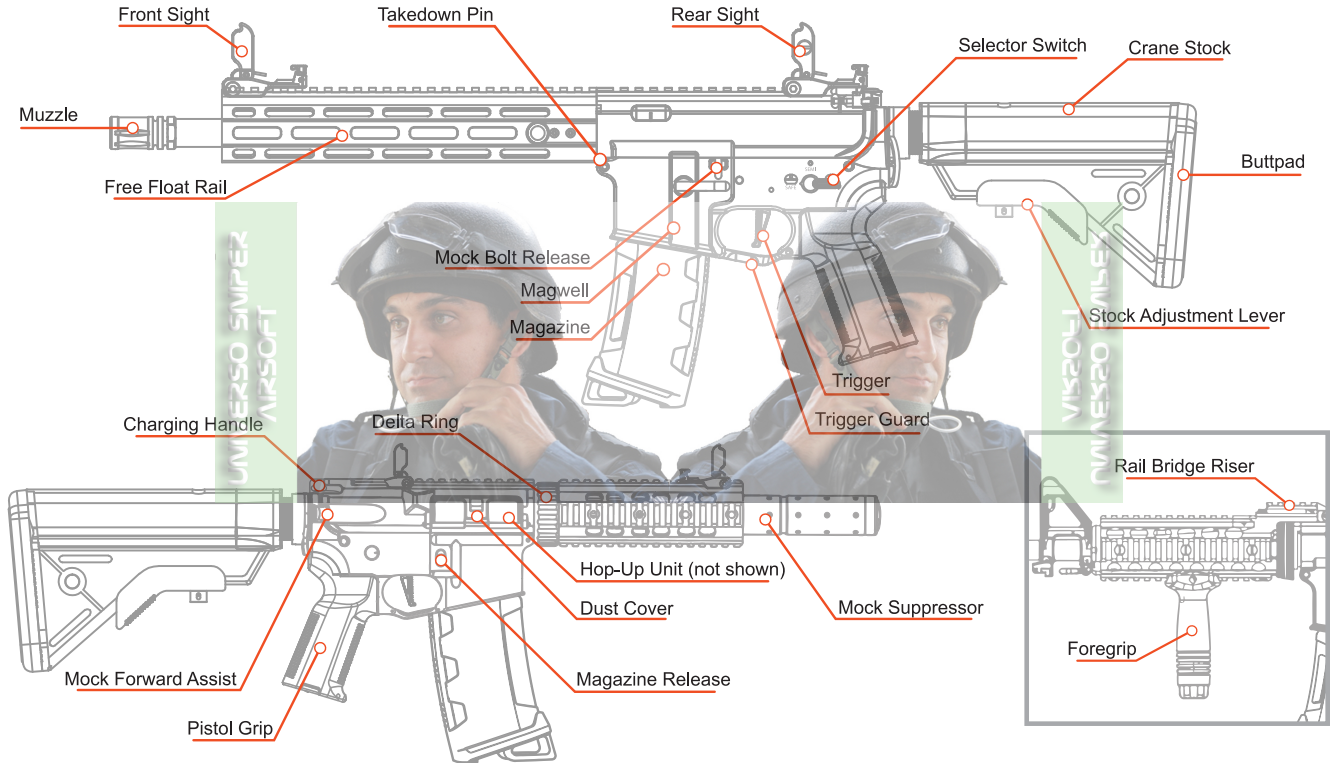

## INSTALLATION

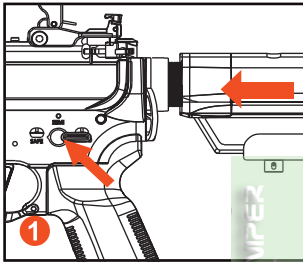

Make sure the selector switch is set to safe & fully retract the stock.

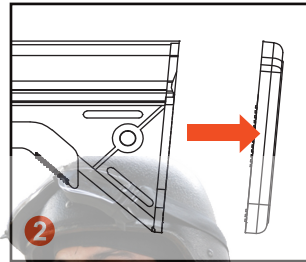

Press the tabs down to release the buttpad from the stock.

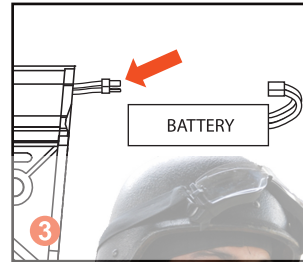

Pull out deans connector from inside the stock.

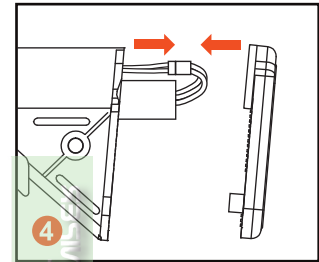

Connect the battery to the connector. Slide the battery into stock compartment. Close buttpad.

## CHARGING BATTERY

Connect the battery to included UL listing wall charger. Directly plug the charger to a regular wall outlet. Charge until the indicator light turns from red to green, then disconnect the battery (overcharging may damage your battery, and potentially other hazards). If battery becomes very hot, safely disconnect your battery from the wall charger immediately. Always store the battery in a cool, dry location.

Charging Time for NiMH/LiPo  
Battery:

Battery: 1600mAh  
Charger: 500mAh = Est. Charge Time:  
4 Hours

# HOP-UP SYSTEM

Proper adjustment of the hop-up will allow the airsoft gun to reach optimal BB trajectory.

\*Always use quality 0.20g or heavier BBs. Lancer Tactical is not responsible for damage resulting from the use of underweight or low quality BBs.

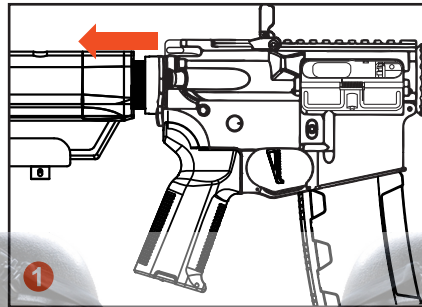

Pull the charging handle back to move the bolt plate back, thus exposing the hop-up adjustment dial. Hold in place while adjusting the hop-up.

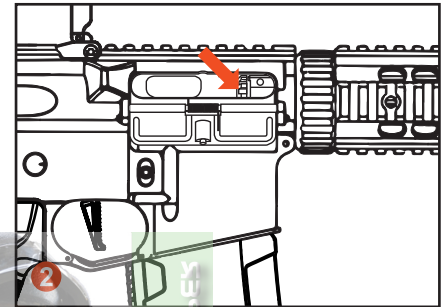

Turning the dial affects the amount of hop-up, or "back-spin", of the BBs.

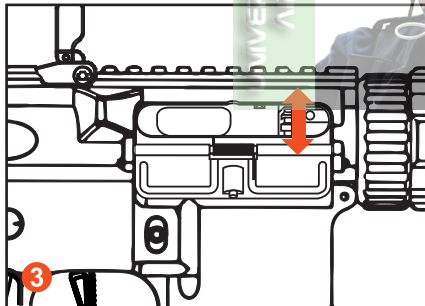

Turning the dial downward will cause the BB to float upwards, whereas turning the dial upward causes the BB to fall downward.

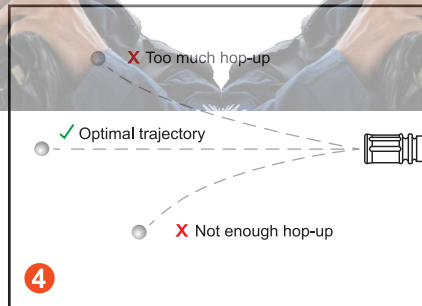

Alternate shooting BBs and making adjustments. Adjust the dial until the BBs shoot straight and the longest flying distance is obtained.

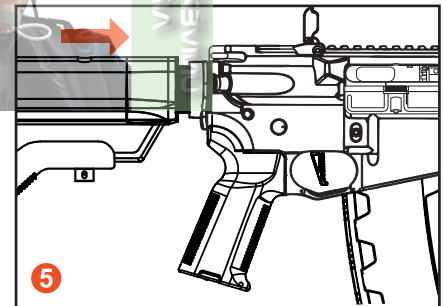

When hop-up is fully adjusted, release charging handle to move the bolt plate back to its original position.

# MAGAZINE / SELECTOR SWITCH

## Load Magazine

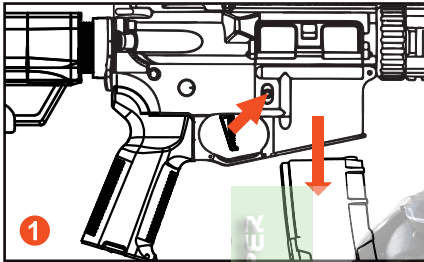

Press the mag release button to remove magazine.

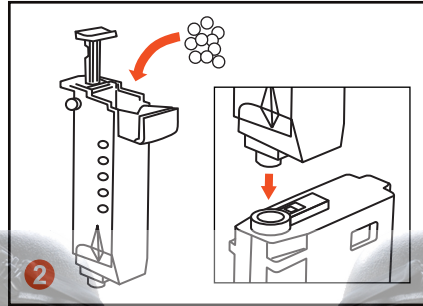

Load magazine using BB speedloader. Do not overfill magazine. Use high quality 0.20g or heavier BBs.

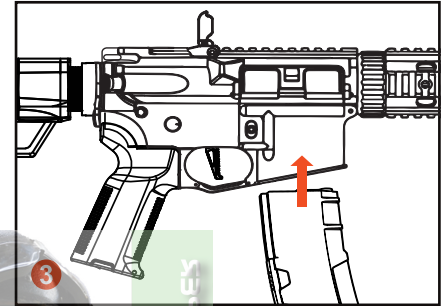

Insert the magazine into the airsoft gun until a click is heard, and mag is locked into place.

## Selector Switch

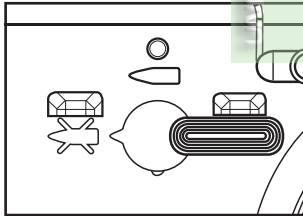

### Safe Mode

Always have the selector switch set to safe when not in use. When set to safe, the trigger will not pull and the airsoft gun will not fire.

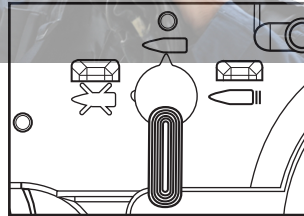

### Semi-Auto

The airsoft gun will fire one single BB each time the trigger is pulled.

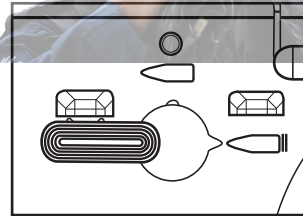

### Full-Auto

The airsoft gun will continuously fire as long as the trigger remains pressed.

### Quick Tip:

If the trigger is stuck while in semi-auto mode, flip the selector switch to full-auto mode and fire several times to reset the cut-off lever. Low battery power may be the cause for this type of problem.

# QUICK-CHANGE SPRING SYSTEM

## SWAPPING OUT THE SPRING

Pre-installed spring has a 380-400 FPS velocity. To reduce speed, follow instructions to switch to low FPS spring that's included.

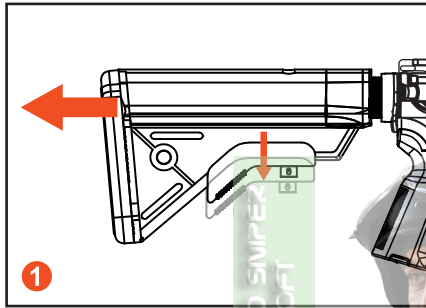

Remove the crane stock by pulling down the stock adjustment lever, keeping it flush to the stock while you pull out the stock.

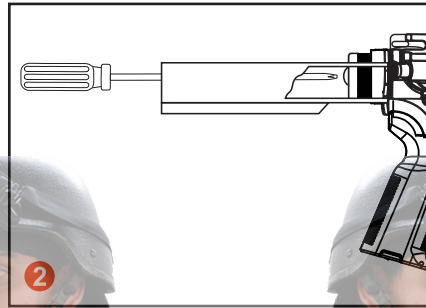

Look into the buffer tube with a light source to spot the Phillips screw. Use an long Phillips screwdriver, resulting in removing the buffer tube, screw and washer from the receiver. **Be careful not to pull or cut the wire.**

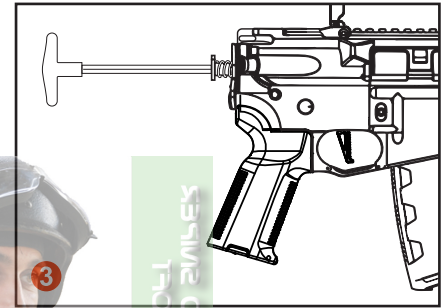

To remove the spring guide from the gearbox, take a 6mm hex tool. Push down and rotate the spring guide a quarter turn to release. Proceed to replace the spring, then restore the airsoft gun.

# DISASSEMBLY (HOP-UP / BARREL / GEARBOX)

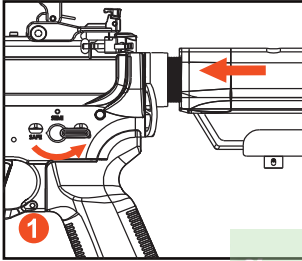

Place the selector switch to safe & fully retract the stock.

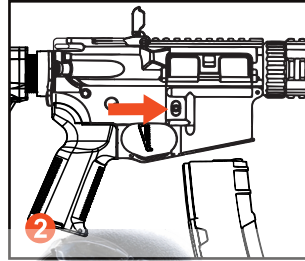

Remove the magazine.

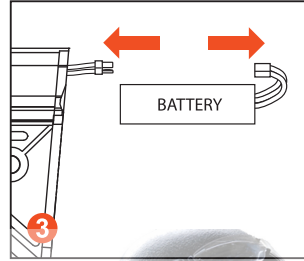

Remove the battery. (See battery installation page)

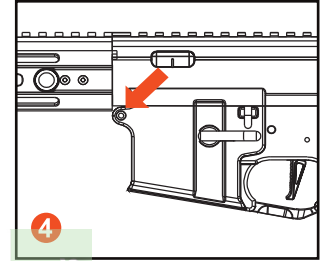

Unscrew front pin with hex key. Tap the front body pin out until the upper receiver disconnects.

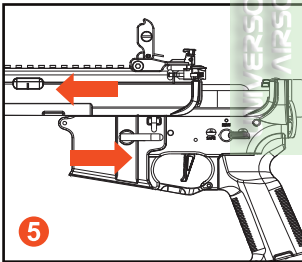

Slide the upper receiver away from the lower receiver.

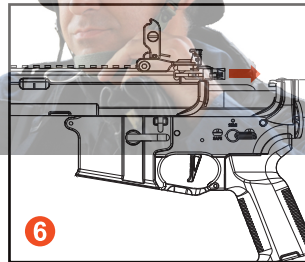

While sliding upper receiver forward, draw back charging handle to work it past obstructions on top of the internal gearbox.

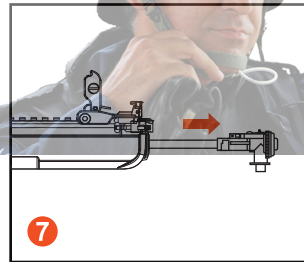

Slide the inner barrel and hop-up assembly out of the upper receiver.

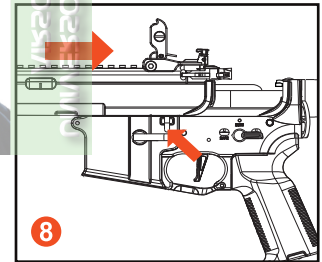

While sliding upper receiver back into place, pull charging handle as in Step 6. And hold down the lower end of the mock bolt release so it does not block the path of upper receiver.



# CLEANING



Wipe any dirt and dust from the surface of the airsoft gun.

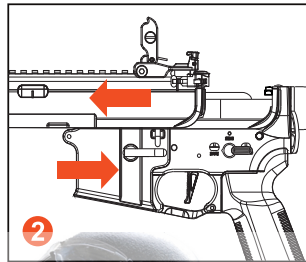

Disassemble the airsoft gun as described in the Disassembly Page.

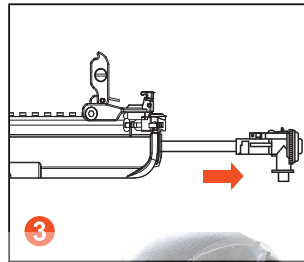

Slide the inner barrel and hop-up assembly out of the upper receiver.

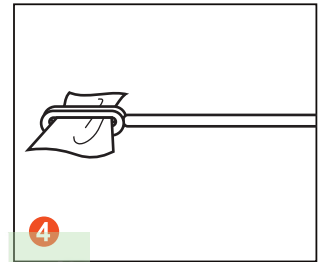

Take a 1" cleaning cloth and attach it through the loop-end of the cleaning rod.

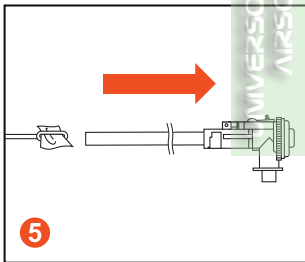

Push the cleaning rod through the inner barrel from front to back.

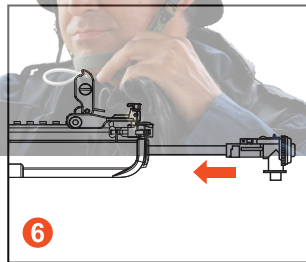

Slide the inner barrel and hop-up assembly out of the upper receiver.

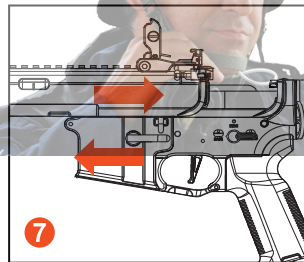

Slide the upper receiver onto the lower receiver.

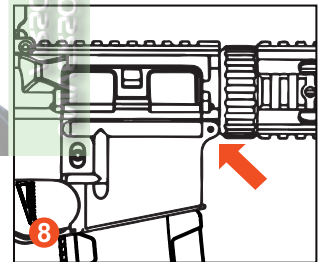

Align the front pin with the lower receiver. Push in the pin to secure both receivers.

SYMPTOMS	CAUSES	SOLUTIONS
Airsoft gun works but no BB output	Magazine feeding issue	Check if magazine is properly loaded into gun Ensure magazine is loaded with BBs
Motor/battery is excessively hot after short usage*	Damaged battery	Inspect and/or replace battery
	Loose connection terminal	Contact customer service for tech support
	Aftermarket battery with too much voltage	Use suggest battery or up to 11.1v
Semi- or Full-Auto mode does not operate properly	Battery voltage or discharge is too high Battery charge low or old battery	Condition, charge, or replace battery
Semi- or Full-Auto modedoes not operate at all	Disconnecter is not engaged properly	Reset the disconnecter: set the selector to safe, then to automatic, then to semi
Firing cycle is slow	Battery is low on power	Charge or replace battery
High-pitched sound or grinding noise while firing	Motor level is not adjusted properly	Contact customer service
BBs fly upward too much	Hop-Up adjusted too high	Adjust for less Hop-Up (see HOP-UP page)
BBs fly downward too much	Hop-Up adjusted too low	Adjust for more Hop-Up (see HOP-UP page)
Barrel double feeding or BBs are rolling out of the barrel	Excessive grease or oil in the Hop-Up chamber	Fire at least 200 rounds to eliminate excessive grease from the chamber clean Hop-Up with supplied cleaning rod
	Hop-Up adjusted too low or too high	Adjust for more Hop-Up (see HOP-UP page)
Hop-Up system cannot adjust	Hop-Up adjustment arm is not set properly	Reset Hop-Up adjustment arm. Contact customer service for instructions
Inner barrel is jamming or is jammed	Use of recycled or low quality BBs	Clear/clean/lubricate inner barrel with cleaning rod and silicone oil (see CLEANING page)
	Inner barrel is contaminated with BBs or debris	
Magazine is not feeding	BBs are lodged inside the magazine	Remove and tap magazine to clear the jam
	Internal obstruction	Contact customer service

\*Some heat is expected after extended use.

# PARTS DIAGRAM

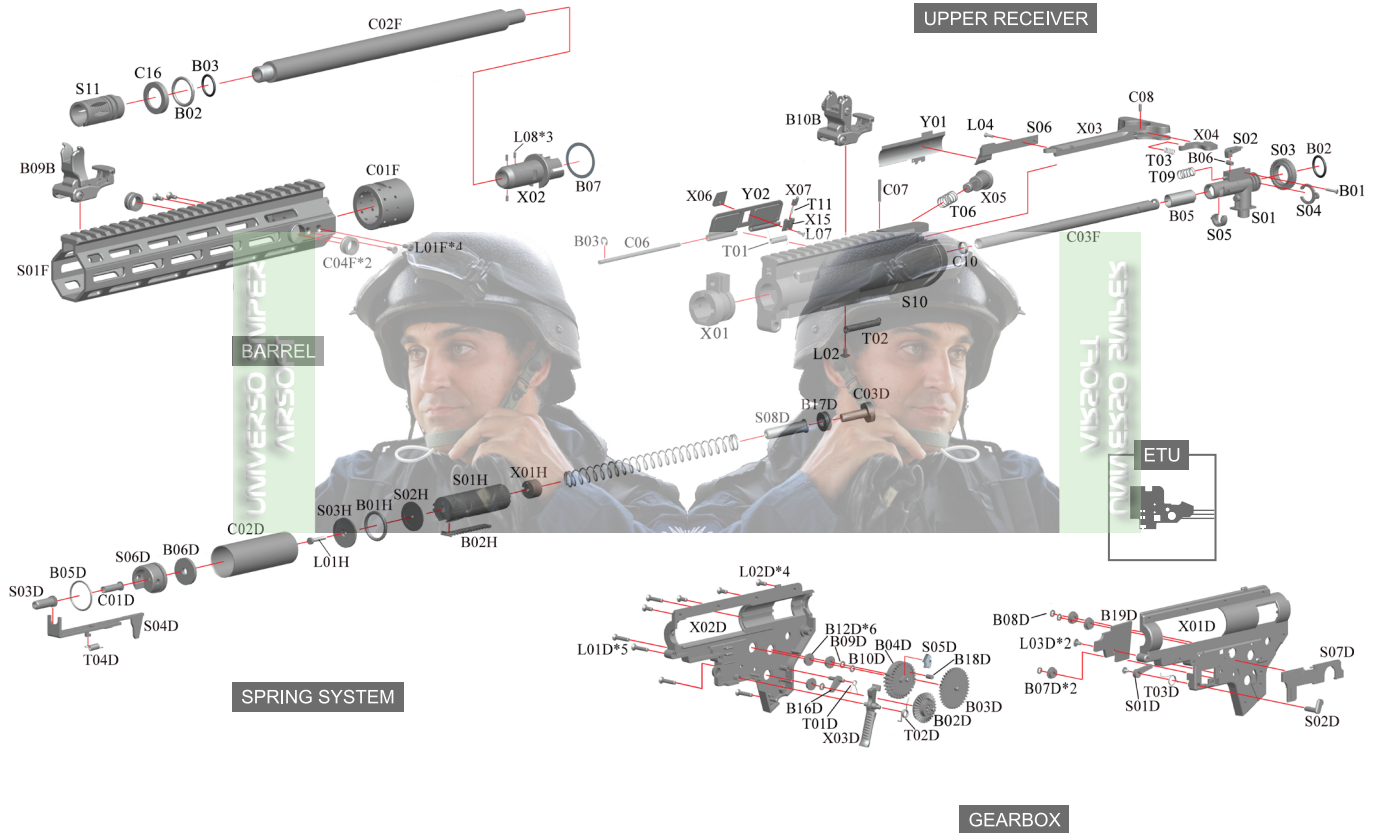

# PARTS DIAGRAM & WARRANTY



12140 ALTAMAR PLACE, SANTA FE SPRINGS, CA 90670  
LANCERTACTICAL.COM

## CUSTOMER SERVICE

(888) 279-7776

[info@lancertactical.com](mailto:info@lancertactical.com)

10am-5pm PST, Monday-Friday (excluding holidays)

Lancer Tactical offers a limited warranty on all registered products sold by our authorized dealers. This limited warranty covers defects in material and/or workmanship for a period of one year from the date of purchase. Proof of purchase must accompany any warranty claim.

Make sure your purchase was made from an authorized dealer before registering your Lancer Tactical product.

For online registration, please scan the QR code provided below, or visit [lancertactical.com/warranty-registration](https://lancertactical.com/warranty-registration)

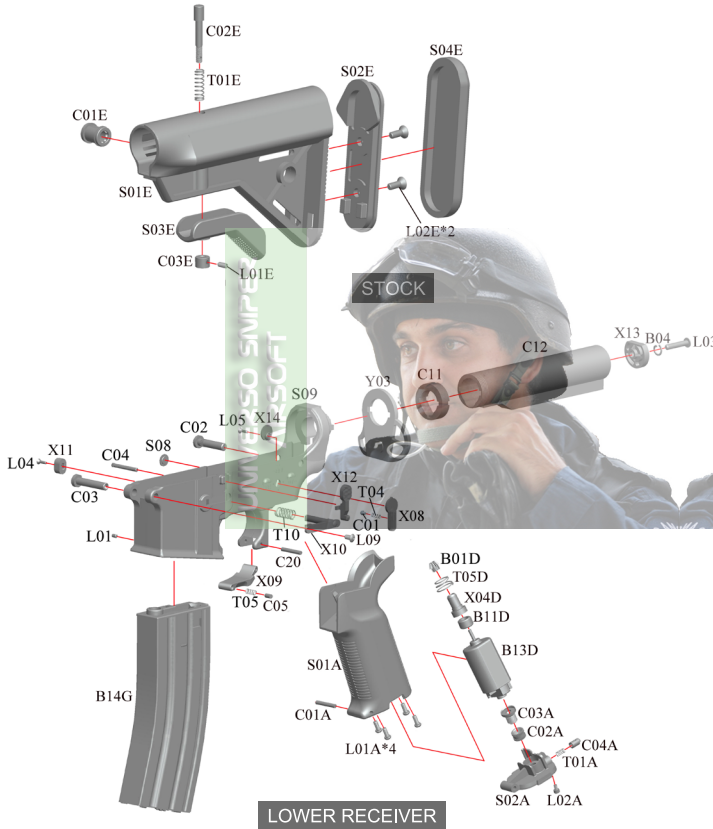
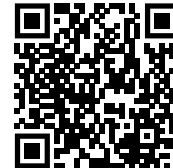

LIMITED WARRANTY  
**ONE YEAR**



**SET TO WIN.**<sup>TM</sup>



LANCER  
TACTICAL

*FIELD TESTED, AIRSOFT READY*

**GEN3**

★ LANCER TACTICAL GEN3 INSTRUCTION MANUAL ★

 PLEASE READ MANUAL COMPLETELY.  
FOR AGES 18 YEARS AND OLDER.