

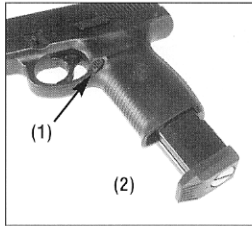

SMITH & WESSON SIGMA 40F SEMI AUTO BLOW BACK *CO2 POWER*

Smith & Wesson® VELOCITY: 360 Fps - POWER: 1.4 Joule - ADJUSTABLE SPIN UP

LOADING



- To remove the magazine, press the release (1) located on the left side of the grip. Slide magazine out (2).

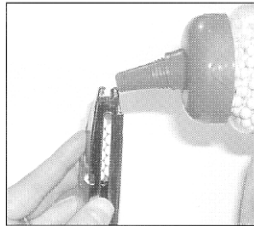

- Load the magazine as shown on the picture. The maximum capacity is 39 rounds.

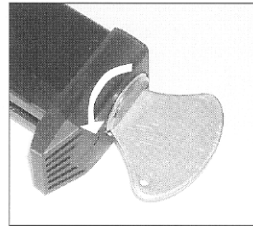

- Unscrew the bottom of the magazine with the tool (or a coin) provided in the kit.

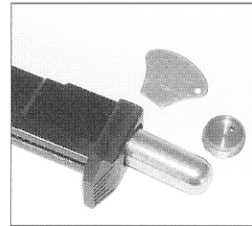

- Insert the CO2 cartridge in the magazine as shown on the picture.

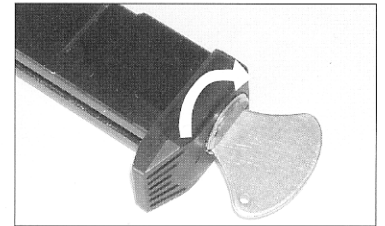

- Screw the bottom of the magazine. When pressure starts increasing in the magazine (expansion of the CO2 in the magazine can be heard), finishing screwing rapidly. Very important: do not tighten excessively, it could permanently damage the O'rings.

SHOOTING

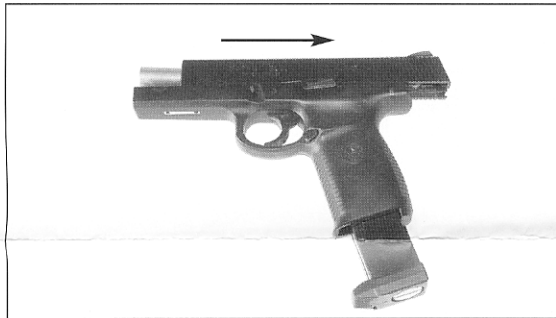

- Pull the slide backward and release, in order to start shooting.

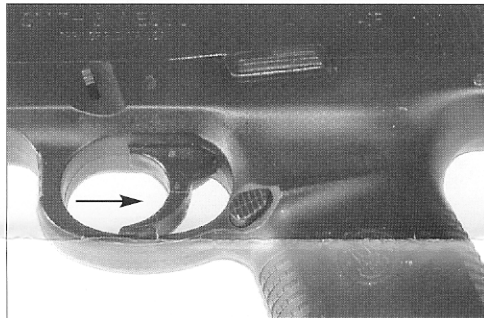

- After, operation is semi-automatic, you just need to pull the trigger.

SAFETY

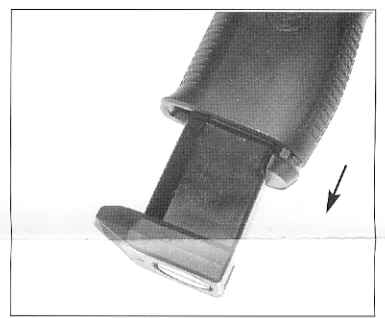

- When shooting is over, check magazine is empty and safety back in the locked position, as indicated on the picture.

REMOVE THE MOUNT RAIL

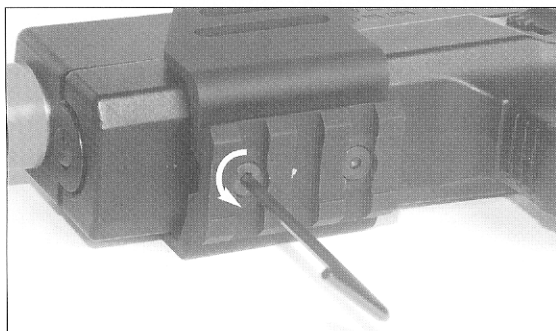

- To remove the mount rail, unscrew as shown on the picture

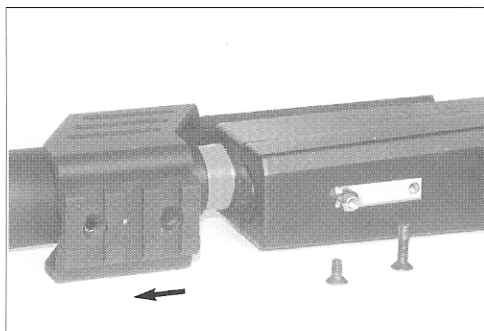

- Slide out the mount rail. Pay attention to the length of each screw for the reverse operation.

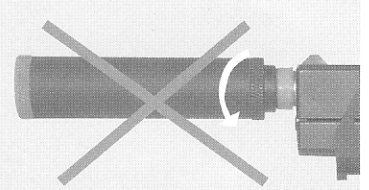

CAUTION!
DISASSEMBLING THIS SILENCER VOIDS ALL WARRANTY. THIS ONE IS STUCK ON THE BARREL.

ADJUSTABLE SPIN UP

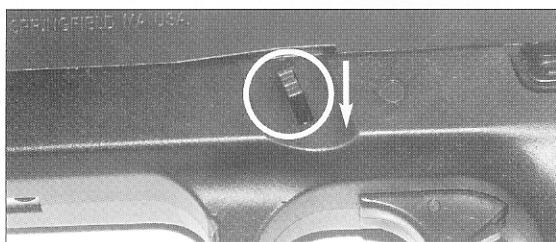

- To adjust the Spin Up, it's necessary to disassemble the slide. Pull down the release buttons on the two sides simultaneously. As you do so, pull the slide forward.

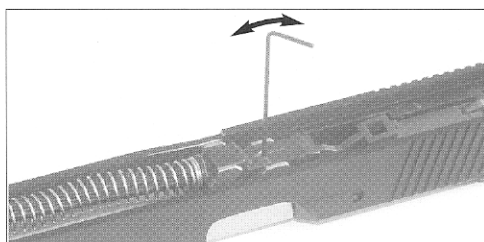

- With the small tool, adjust the Spin Up at your convenience.

Distributed by:



www.softairusa.com