

COLT M16A3 EXPOSE PLAN

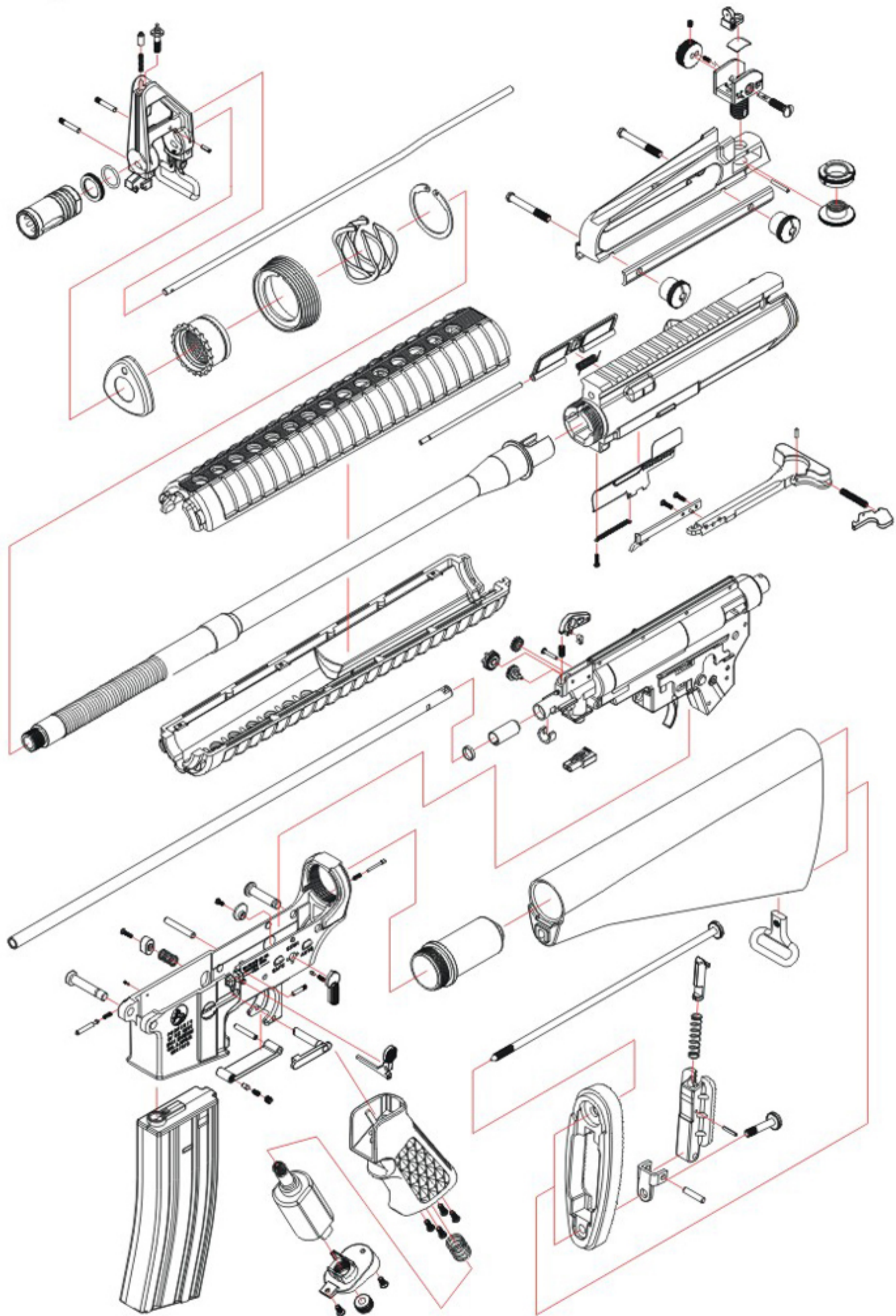

SAFETY

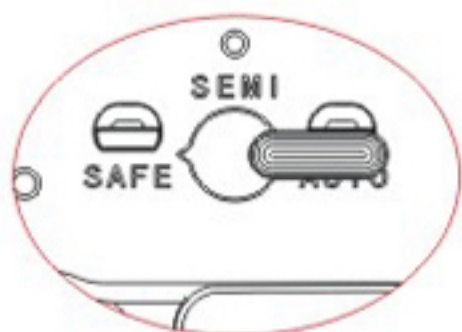

SINGLE



AUTO

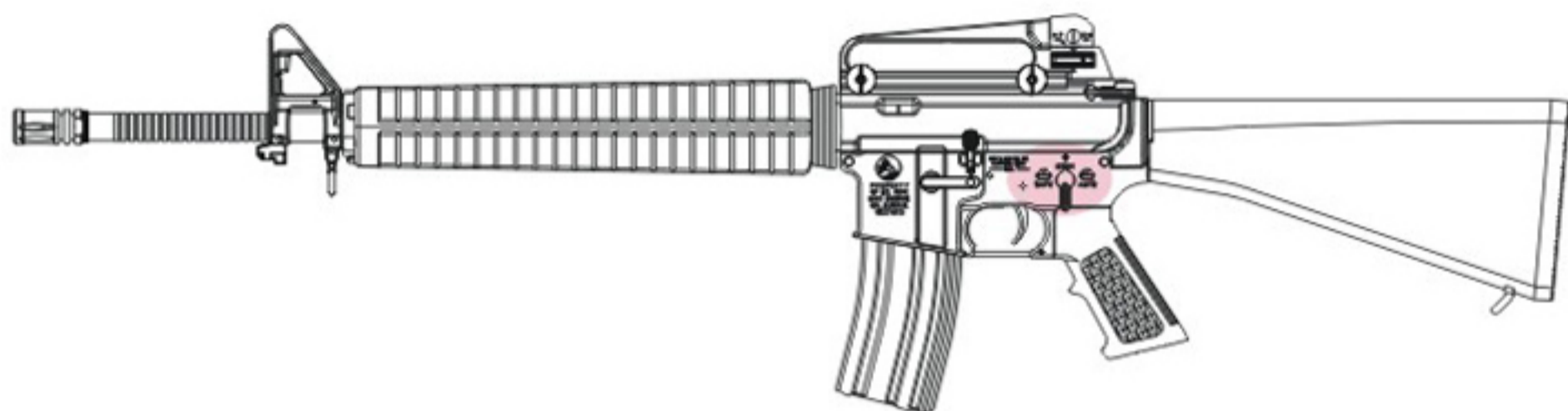
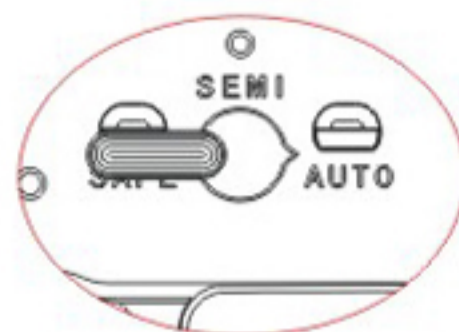

BATTERY INSTALLATION

USE THE SPECIFIED BATTERY FOR YOUR GUN 9.6V 1700MAH

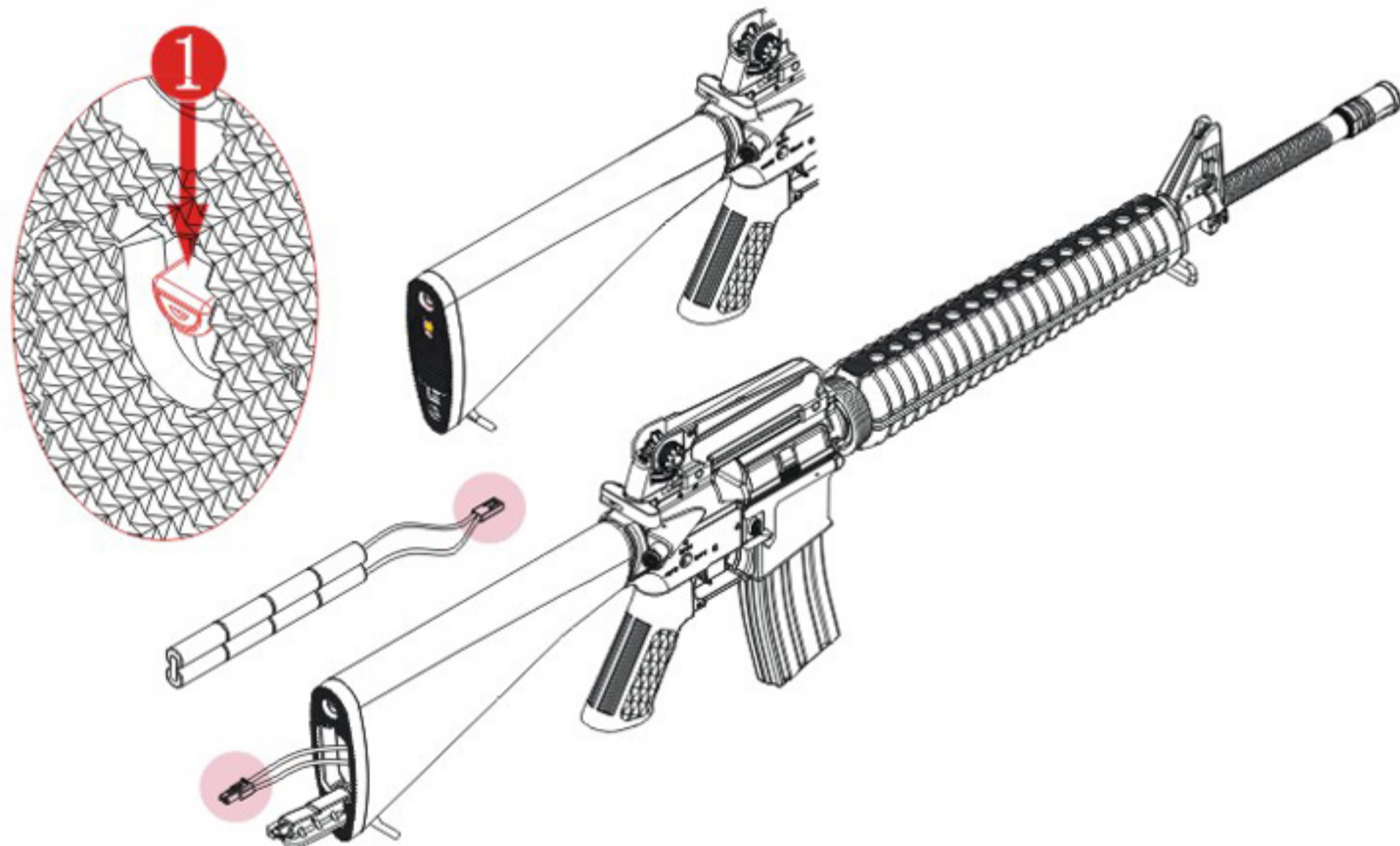

BOLT LOCK & RELEASE

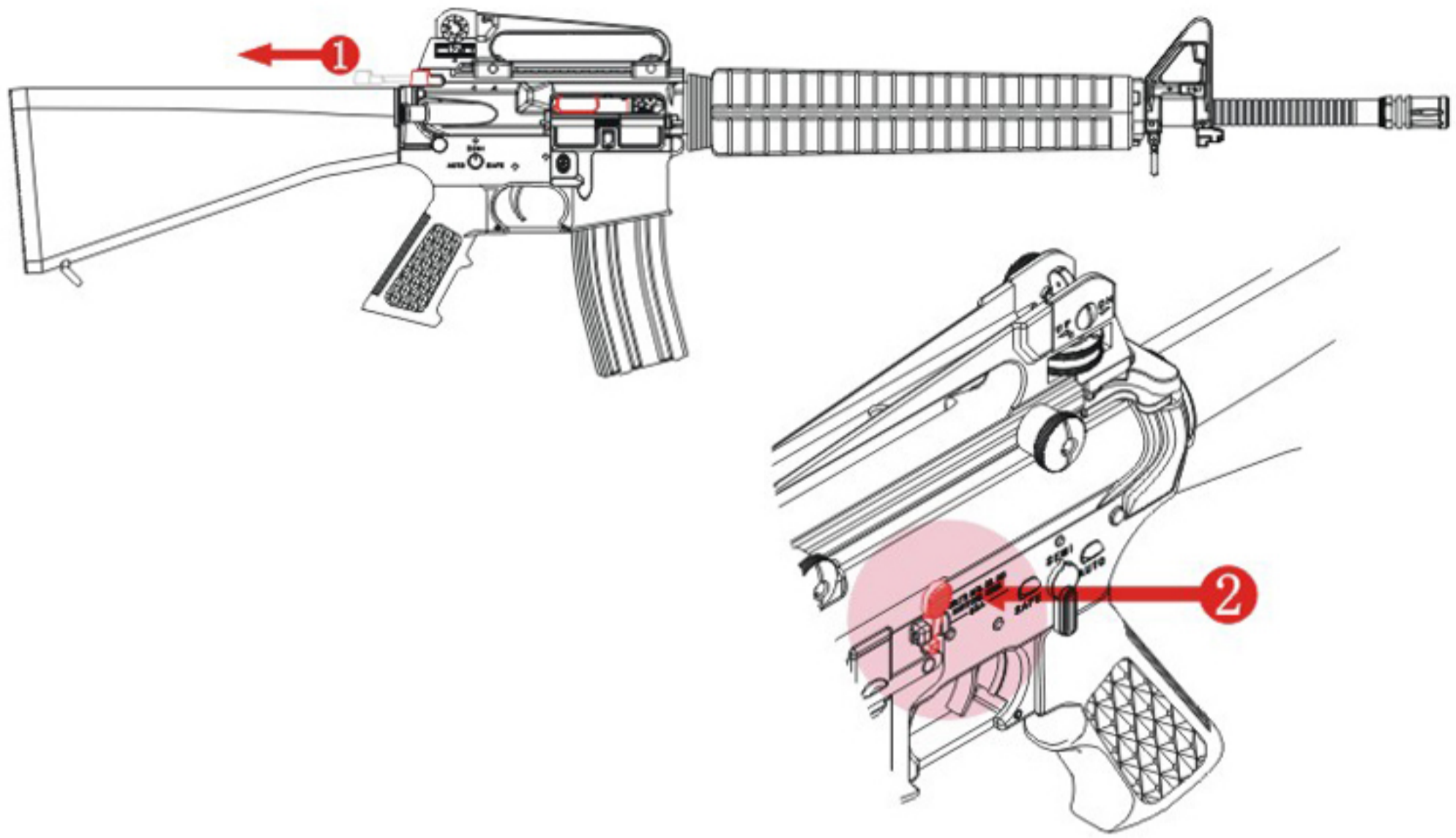

HOP-UP ADJUSTMENT

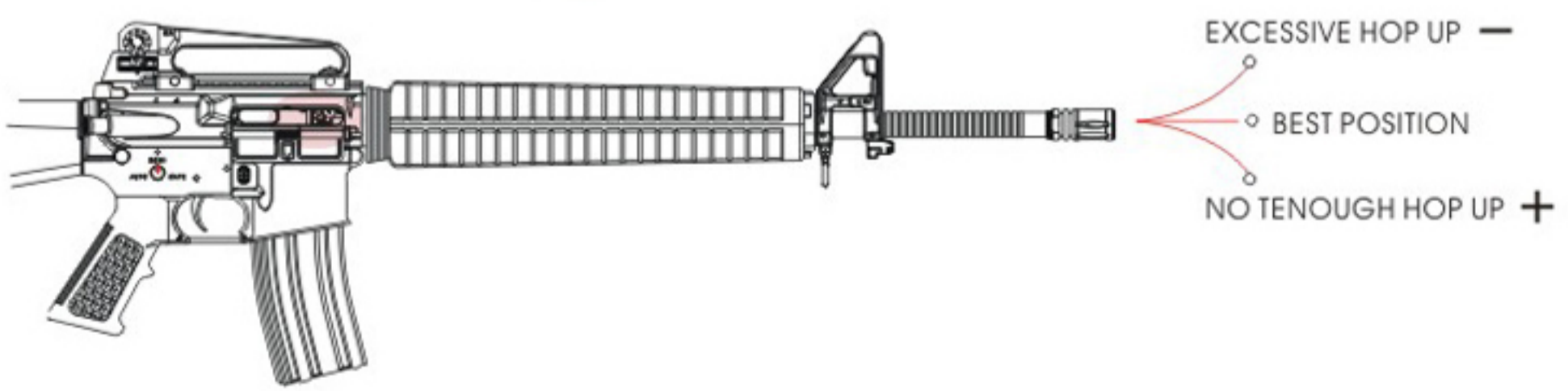
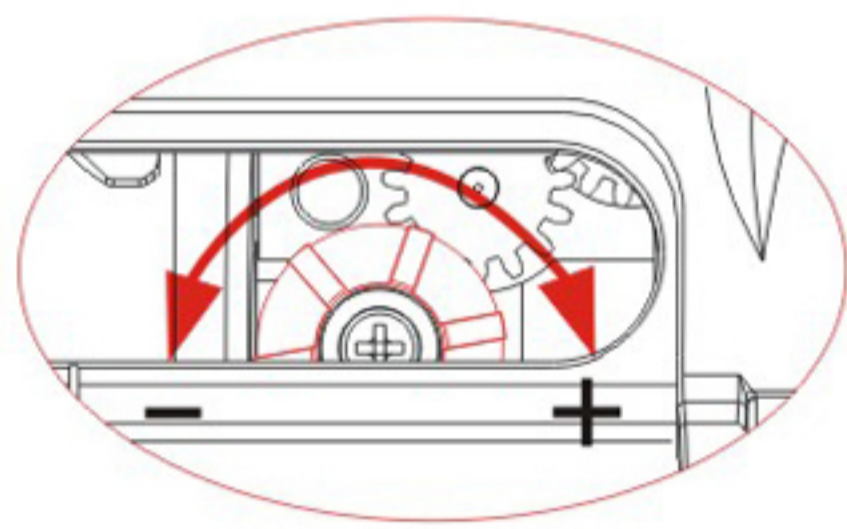

SETTING THE MAGAZINE

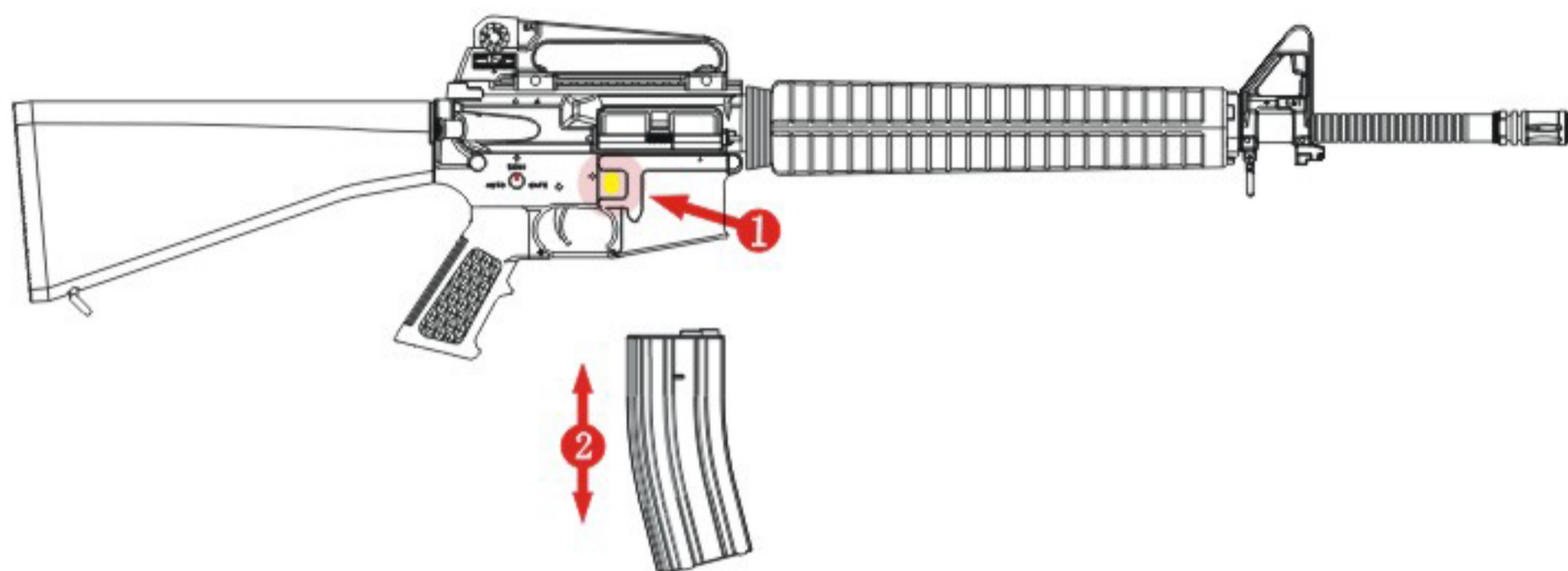

WARNING

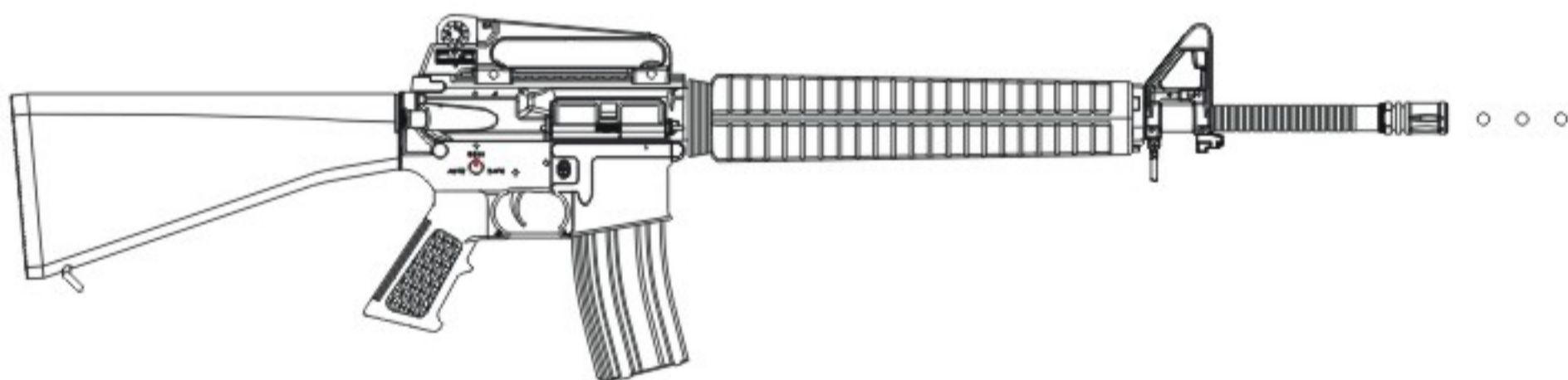

- . Do not aim or shoot a person or animal as the target.
- . Avoid pulling the trigger carelessly.
- . Always put the gun in a case or bag when you carrying it.
- . Always set the switch lever to the safety position.
- . Do not look into the gun muzzle.
- . Always wear eye protective gear.
- . Store the airsoft gun at the places out of reach by children.
- . Do not disassemble or modify the airsoft gun.

DATA OF COLT M16A3 ELECTRIC GUN

MATERIAL: ALUMINUM & NYLON FIBER

HOPUP SYSTEM: ADJUSTABLE

LENGTH: 1000MM

WEIGHT: 2965G (WITH MAGAZINE)

MAGAZINE CAPACITY: 140 ROUNDS

BULLET: 6MM BB BULLETS

BATTERY: 9.6V 3300MAH

MOTOR: HIGH TORQUE FLAT MOTOR