



VegaForce Company
<http://www.gb-tech.com.tw>

操作說明

OPERATOR'S MANUAL

Umarex **HK G36C GBBR**

6mm Gas Blow Back Airsoft Gun



Item No:UM2E-G36C-BK01

操作說明

OPERATOR'S MANUAL

■ 大部分解 Fieldstrip



移除護木固定梢。

Remove the Locking Pin from the Handguard.



插梢可置放於槍托之容納槽。

The Locking Pins can be stored in the hole in the Buttstock.



移除護木。

Remove the the Handguard.



移除彈匣井固定梢。

Remove the Locking Pin from the Magwell.



按壓彈匣釋放鈕，並將彈匣井向下取出。

Push the magazine catch, swivel the Magwell downward and detach.

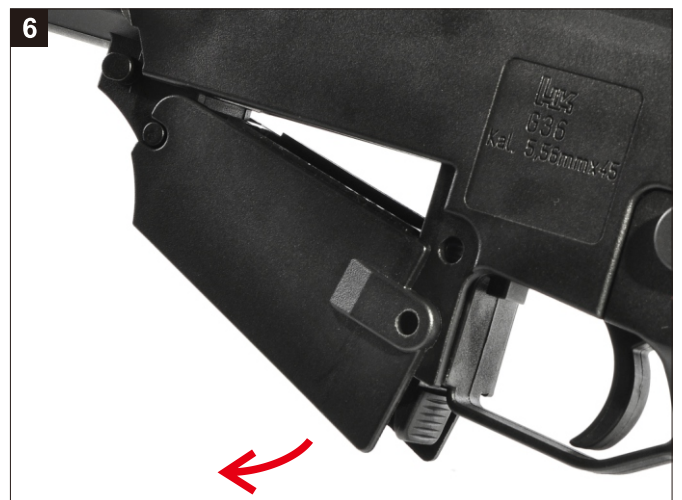

操作說明

OPERATOR'S MANUAL

■ 大部分解 Fieldstrip



移除握把固定梢。

Remove the Locking Pin from the Trigger Group.



卸下扳機組。

Remove the Trigger Group.

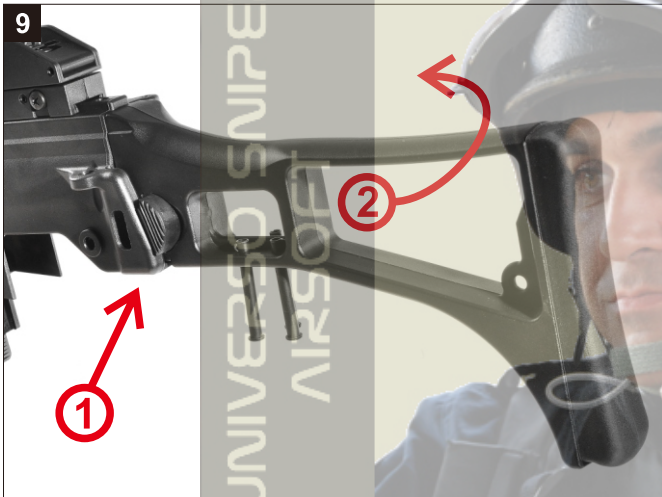

按壓槍托固定鈕並轉動槍托至定位。

Fold the buttstock in half and lock in place.



向下扳動複進簧連桿以解除固定。

Push downward to release the Recoil Spring & Guide Rod.

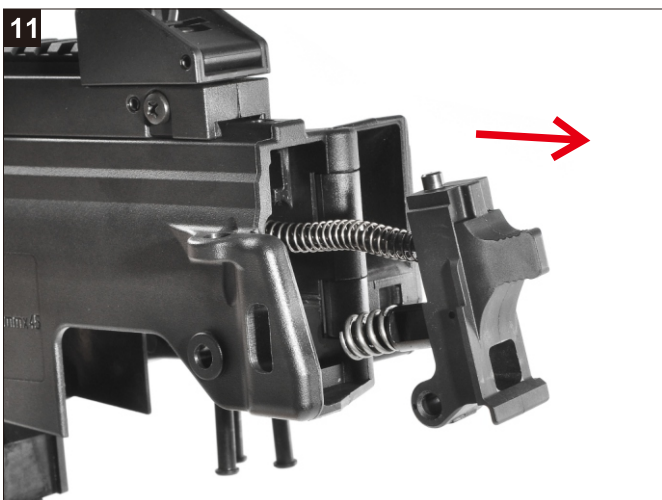

移除複進簧連桿。

Remove the Recoil Spring & Guide Rod.



移除槍機組，完成。

Remove the Bolt Group.

操作說明

OPERATOR'S MANUAL

■ 分解槍機組 Bolt Disassembly

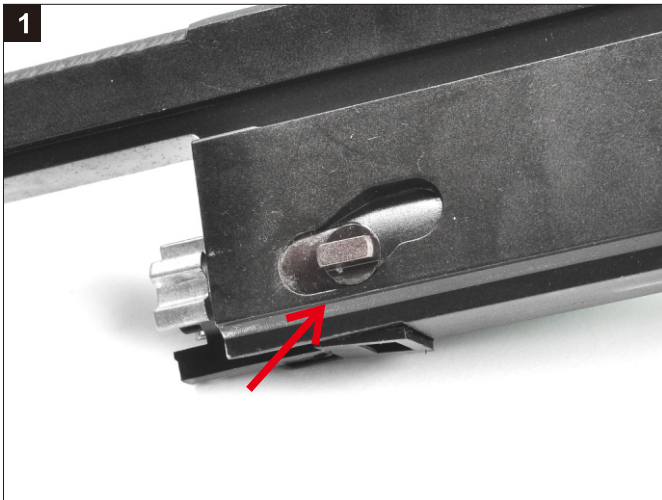

1 移除槍機頭固定片。
Remove the Bolt Head Holder.

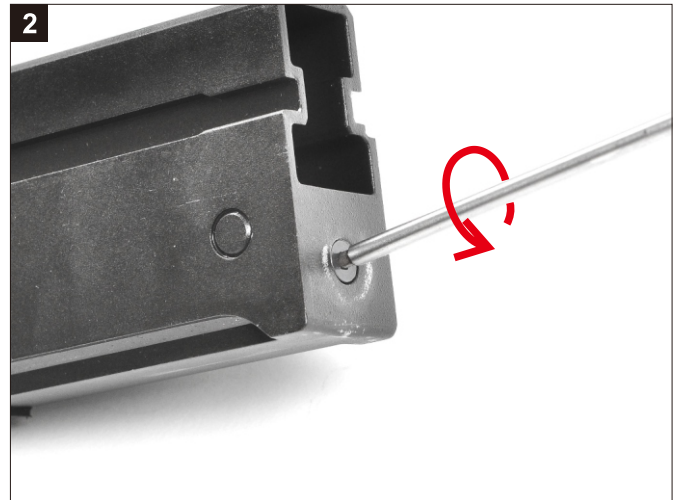

2 移除進彈浮動嘴固定螺絲。
Remove the screw.



3 移除進彈浮動嘴。
Remove the Loading Nozzle.



4 移除槍機頭外罩。
Remove the Bolt Head.



5 移除進彈浮動嘴尾座。
Remove the Piston



6 取出進彈浮動嘴零件，完成。
Disassembly completed.

操作說明

OPERATOR'S MANUAL

■ 分解槍管組 Barrel Disassembly



以順時針方向轉下防火帽。

Release the Flash Hider.

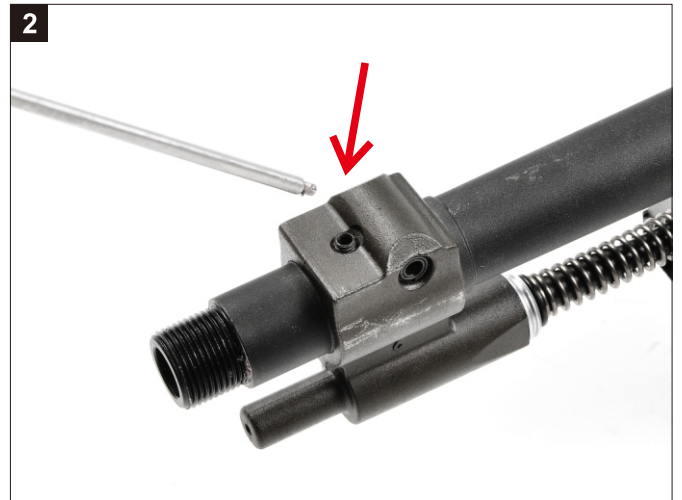

移除導氣座固定螺絲。

Remove the Gas Block Screw.



以專用工具將槍管固定環旋出。

Unscrew the Barrel Nut with the Barrel Nut Wrench.

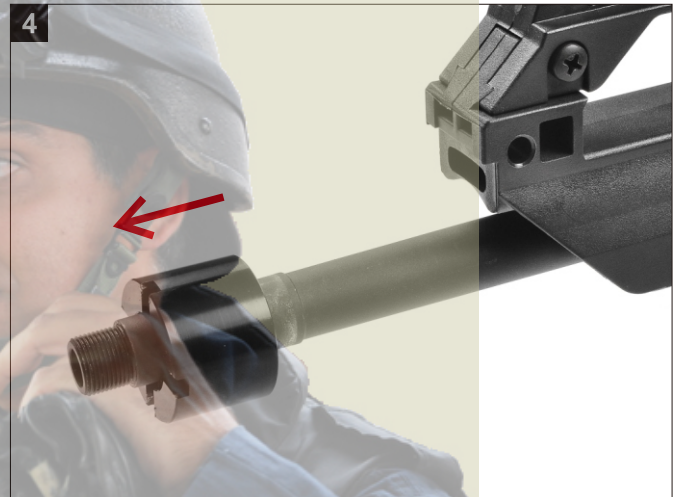

移除槍管固定環。

Remove the Barrel Screw

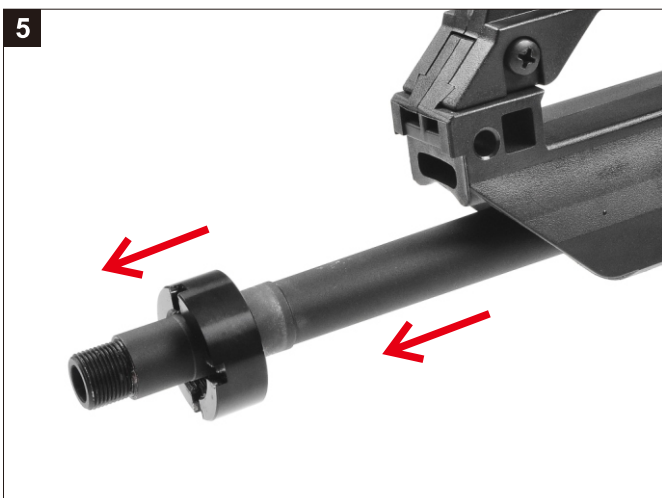

以專用工具旋出Hop-Up座固定環並同時取下槍管。

Unscrew the Chamber Nut with the Barrel Nut Wrench and remove the barrel.

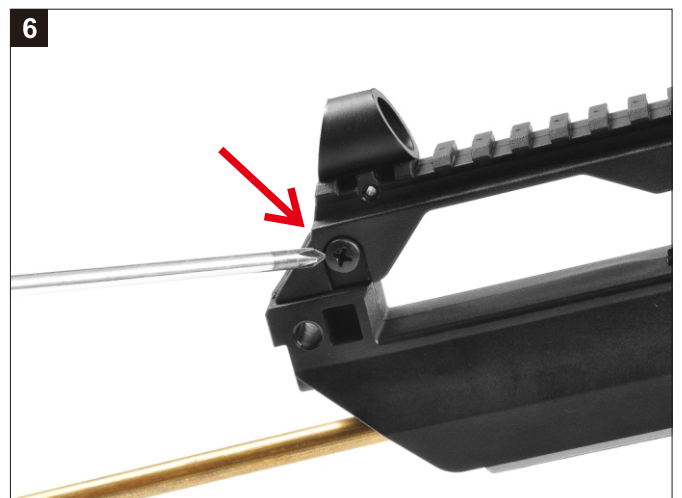

移除提把固定螺絲。

Remove the screw from the Harry Handle.

操作說明

OPERATOR'S MANUAL

■ 分解槍管組 Barrel Disassembly

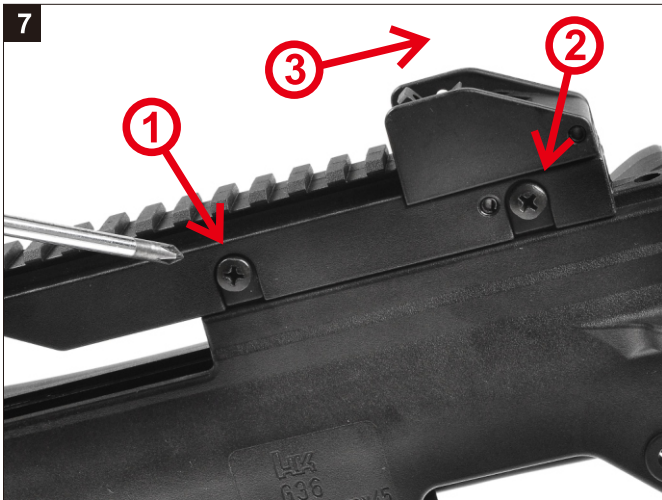

移除1號螺絲並將放鬆2號螺絲，提把即可向後滑出。
Carry Handle can be detached when you remove the screw no.1 and untighten the screw no.2.



※注意，此步驟可能造成Hop-Up調整鈕損壞。
CAUTION, This Step Might Break Your Hop-Up Switch.

移除Hop-Up調整鈕。
Remove the Hop-Up Switch.

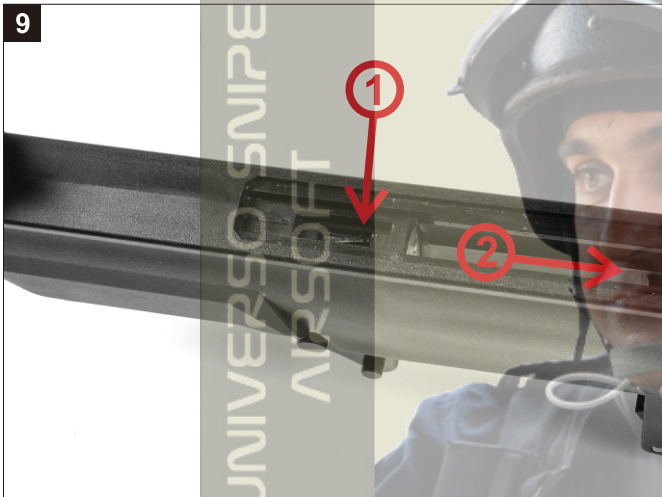

按壓Hop-Up壓板，並向後取出槍膛座與內槍管。
Press the Hop-Up pressure plate and pull the Chamber out.

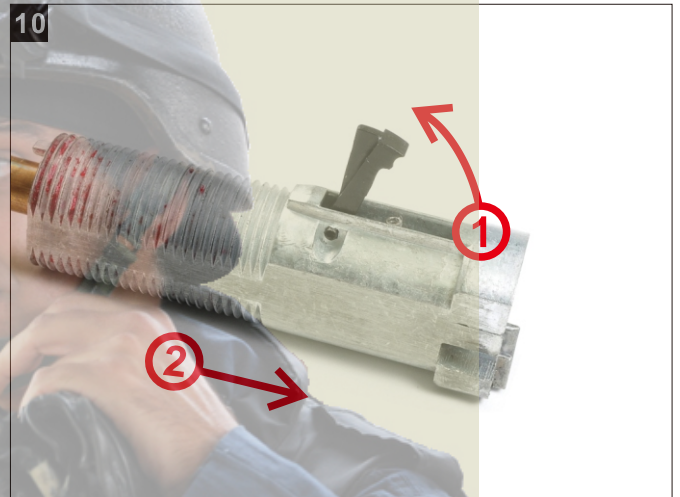

鬆開Hop-Up壓板並分離槍膛座與Hop-Up座。
Swivel upward the pressure plate and pull the inner barrel out.

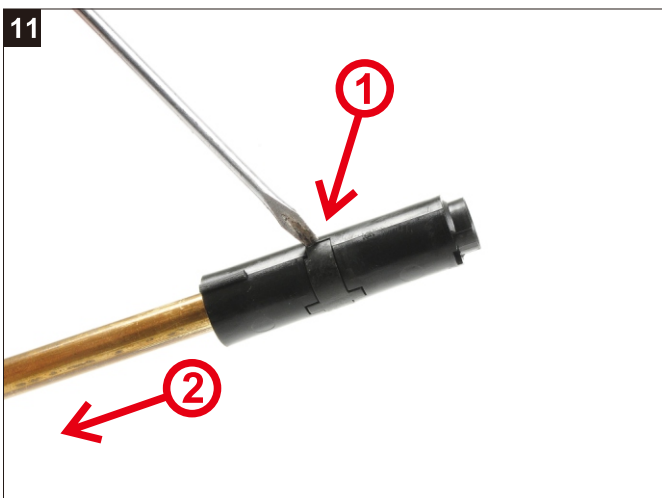

移除Hop-Up座固定卡榫，並取出內槍管。
Remove the Hop-Up Inner Barrel Clamp.



移除Hop-Up橡皮，完成。
Now you can change your Bucking.

■ 分解彈匣 Magazine Disassembly



以工具將彈匣底板卸下。
Remove the Magazine Baseplate.



卸下彈匣固定螺絲。
Remove the Screws from the Magazine.

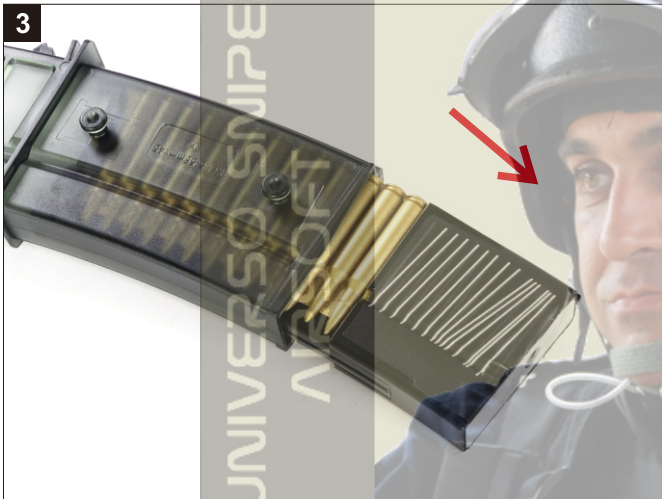

卸下彈匣內膽。
Remove the Magazine Inner Tank.



卸下彈匣出氣橡皮。
Remove the Magazine Rubber.



以專用工具將彈匣氣閥卸下。
Remove the Valve by using a specific tool.



卸下灌氣嘴，完成。
Remove the Inject Valve.