



! CAUTION / WARNING

Before using the Gas Blow Back Rifle, read and follow this instruction.

1. Treat the weapon as it's always loaded.
2. Never load the weapon except you are intend to fire it.
3. Keep your finger away from the trigger.
4. Wear goggles before shooting.



VegaForce Company
www.gb-tech.com.tw

No.68, Jianguo 2nd Rd., Xinzhuang Dist,
New Taipei City 242, Taiwan
Phone: +886-2-2203-6630
Fax: +886-2-2203-6610
e-Mail: service@vegaforce.com.tw

VER. 201508

M4 / AR SERIES
Cal. 5.95 mm GSA BLOW BACK RIFLE
INSTRUCTION MANUAL

Component Name

⚠ CAUTION: All Parts For Airsoft Use Only.

⚠ CAUTION / WARNING

- ⚠ Always wear eye protective gear.
- ⚠ You may be punished if you are shooting for practical jokes.
- ⚠ Never shoot the gun at places where people and cars pass cross.
- ⚠ Never aim or shoot a person or animal as a target.
- ⚠ Never look into the gun muzzle.
- ⚠ Always direct the muzzle towards a safe direction.
- ⚠ Avoid pulling the trigger carelessly.
- ⚠ Please put away from your fingers from the trigger, except when you are ready to shoot a target.
- ⚠ Always put the gun in a case or bag when you are carrying it.
- ⚠ Keep out of reach of children.

⚠ POLICY

- According to the law, The VegaForceCompany's products **FOR TOY AND COLLECTION ONLY.**
- **DO NOT ILLEGAL MODIFICATION THE AIRSOFT GUN.** We also condemn any illegal activities.

UNIVERSO SNIPER AIRSOFT



Right Side

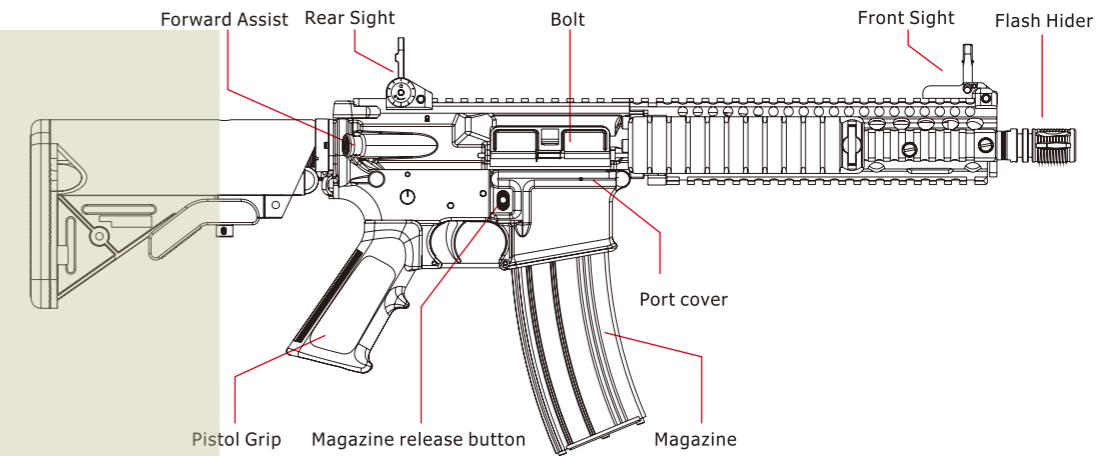

Left Side

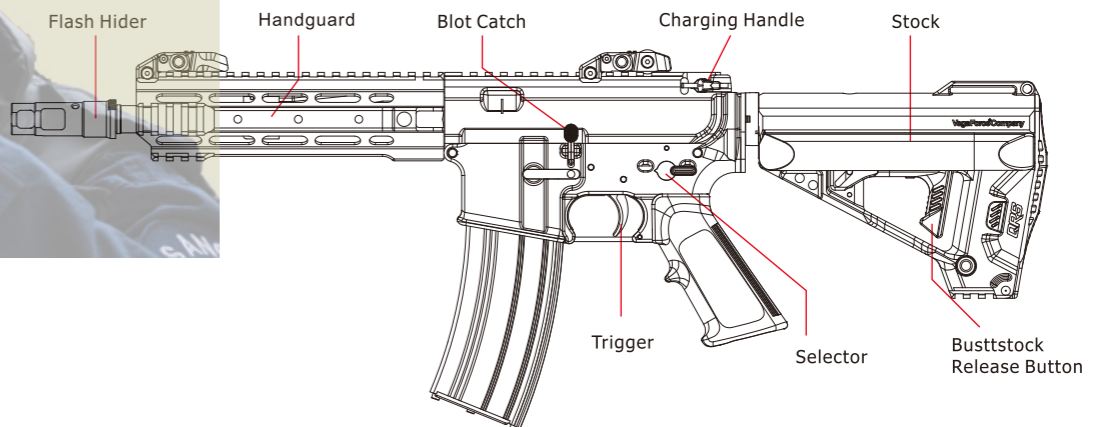

Selector & Safety Setting

■ Safety Setting

The trigger can not be pulled.

⚠ CAUTION:
 If The Rifle Is Not Cocked, The Selector Lever Can Not Be Pointed Toward The Safety Setting.

■ Semi Auto

Pulled the trigger, the gun will fire one shot each time.

■ Full Auto

The gun will fire automatically while the trigger remains pulled.

■ Right Side

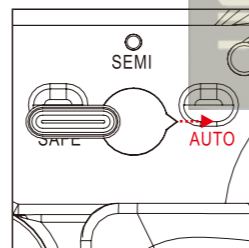
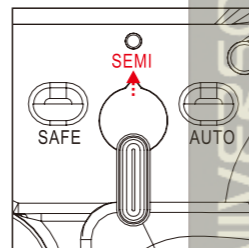
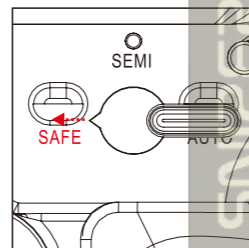

■ Left Side

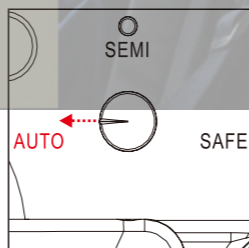
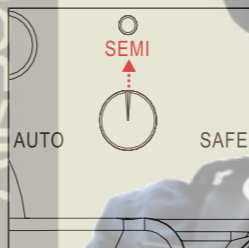
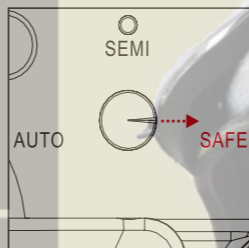

⚠ CAUTION: Point Rifle In A Safety Direction!

Check Before You Fire

1 Remove the Magazine

Press Magazine catch button and move the magazine.

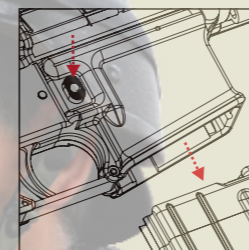

3 Check the Selector Lever

Perform safety function check to ensure that safety selector lever works properly.

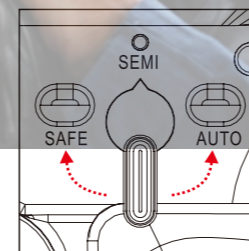

2 Cocking the Bolt

Lock Bolt open, pull Charging handle rearward to check that there is no BBs in the chamber, Return Charging handle to forward. If there is, please remove the BBs from the chamber. Check the Bolt and Charging handle to ensure free movement in the receiver.

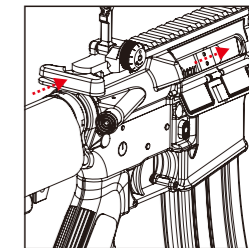
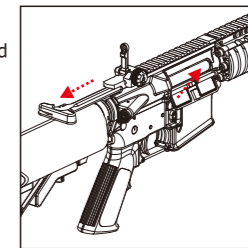

⚠ CAUTION: Do Not Put Your Finger Into The Chamber, It's Dangerous.

4 Safety Setting

Place safety selector lever on safe.
NOTE: Point rifle in a safety direction!

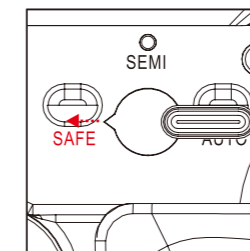

⚠ Bolt Forward Assis

If the bolt didn't forward and lock. Please push the forward assist or pull the Charging handle several times to ensure the bolt is fully forward and locked.

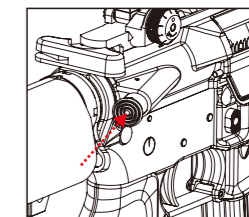

NOTE: ALWAYS USE THE VFC HIGH QUALITY BB PELLET FOR YOUR AIRSOFT RIFLE.

Load the BBs

BB Loader

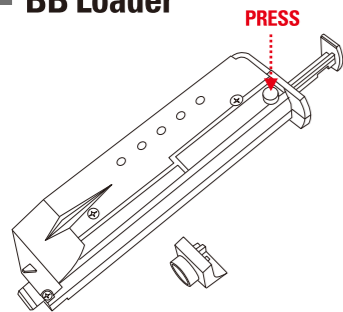

- !** Always use the quality BBs for this airsoft gun. We will not be held responsible for any damage and accidents arising from using of bad quality BBs.
- Diameter larger than 6mm
 - No True round BBs
 - Both halves not aligned
 - With edges
 - Used or soiled

Insert the BBs to Loader

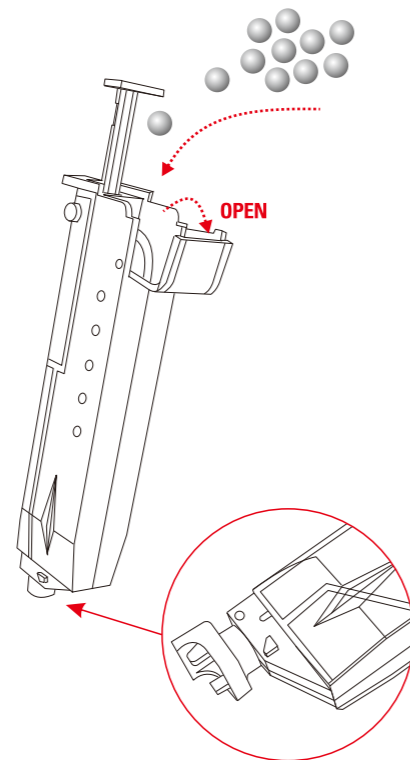

Load BBs

Insert the BBs into the Magazine.
 The maximum capacity is 30 round.



CAUTION: Do Not Force To Over Load.

Filling the GAS

Push the gas canister nozzle into the Filling gas nozzle.
 Make sure the canister is in vertical position when charging.

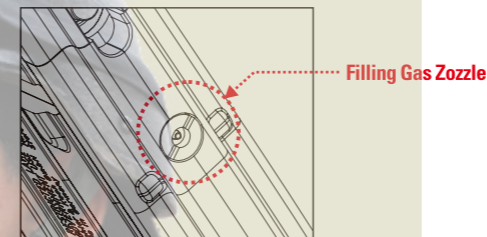

! For the better performance of the GBB rifle.
 Do not shoot the rifle right after charging the gas.

Release the GAS

Please discharge the magazine by
 press the value gently, for releasing residual gas.

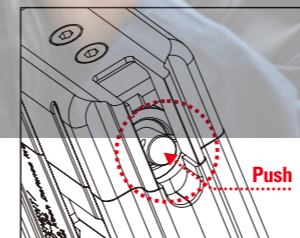

! You may experience a delay action if the surrounding temperature drops below 20° C/68° F. Remember, do not expose magazine directly under the sun or incinerate the magazine, it may cause bursting. It is strongly recommended to empty gas from magazine after shooting. Be sure to avoid direct gas contact with Eyes or Skin when gas is being released, it will cause frostbite.

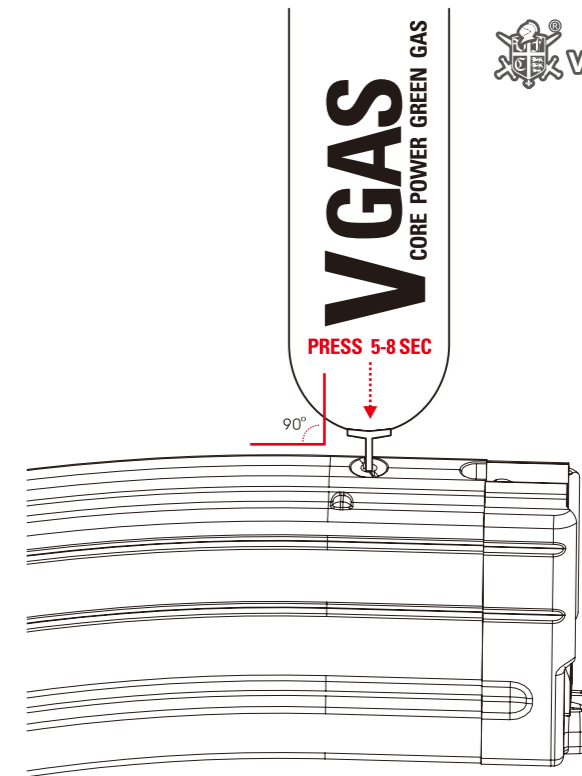

- !**
1. Check canister for any cracks or leaks before using.
 2. Do not expose canister over 40° C/ 104° F.
 3. Do not leave canister directly over fire.
 4. Do not boil canister.
 5. Keep canister away from direct sunlight.
 6. Do not leave canisters inside the vehicle

⚠ WARNING: Always Point The Muzzle In A Safe Direction.

Setting Magazine and Firing

1 Insert the Magazine

Push magazine up in to magazine well. Make sure to set the magazine upwards and connect it firmly until a **CLICK SOUND** is heard.

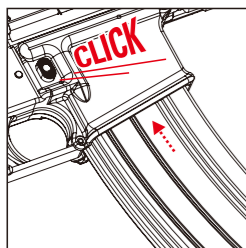

3 Return the Charging Handle

forward the charging handle to locked position.

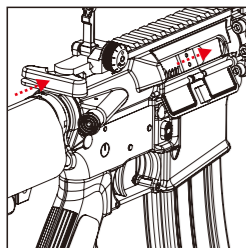

2 Check the Chamber

Open bolt and check firing chamber. Make sure it is clear.

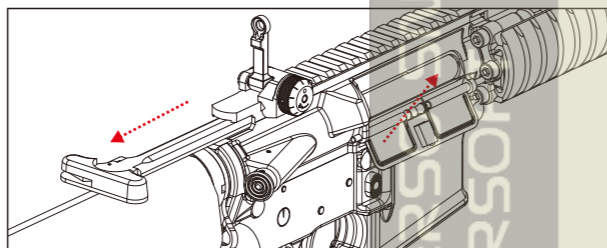

4 Firing Mode Select

Place safety selector lever on Semi Auto or Full Auto. Pull the Trigger to fire.

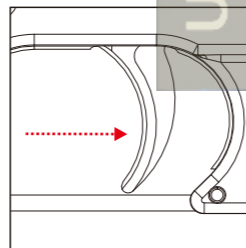
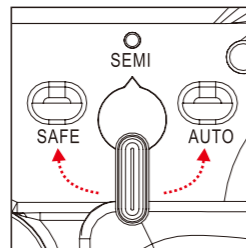

5 Release Bolt

Press the Button release Bolt to Chamber.

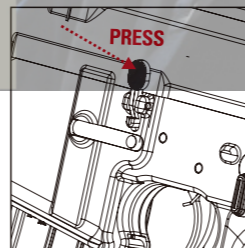

Variable HOP-UP System

1 Remove the Magazine

Press Magazine catch button and move the magazine.

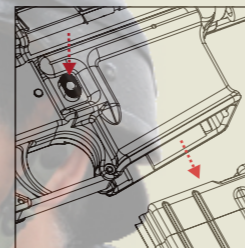

4 Remove the Bolt

Pull back the charging handle Remove the bolt carrier and blot.

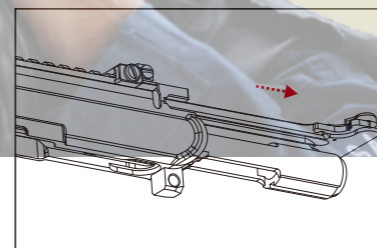

2 Pull Up the Take Down Pin

Push in Take down pin as far as it will go. Pivot Upper receiver from lower receiver.

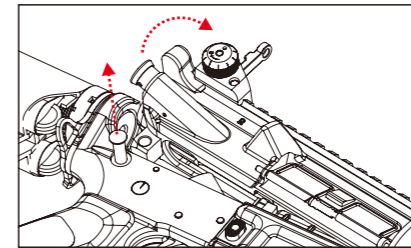

3 Pull Up the Pivot Pin

Push in pivot pin. Separate Upper and lower receiver.

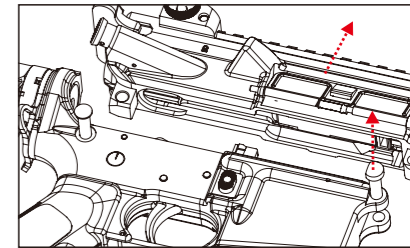

5 HOP-UP Adjustment

Use the hexagon keys (included) adjust HOP-UP.

⚠ Remove Charging Handle by Pulling Back and Up Until "ears" Clear Cutouts In Receiver.

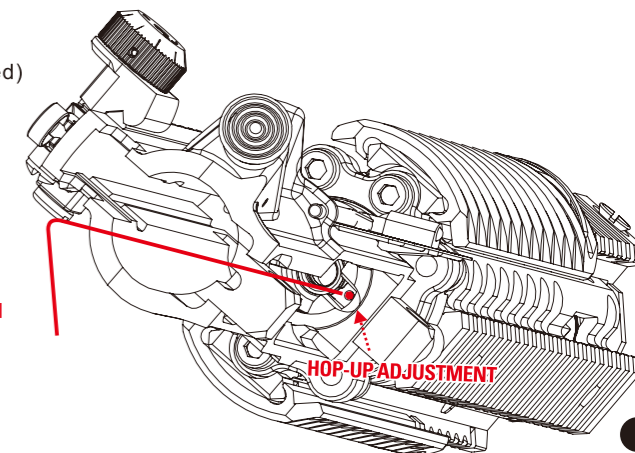

Variable HOP-UP System

5 Adjust HOP Effect

Turn the adjustment towards **"CCW"** to give bullets more hop up.
 Turn the adjustment towards **"CW"** to give bullets less hop up.

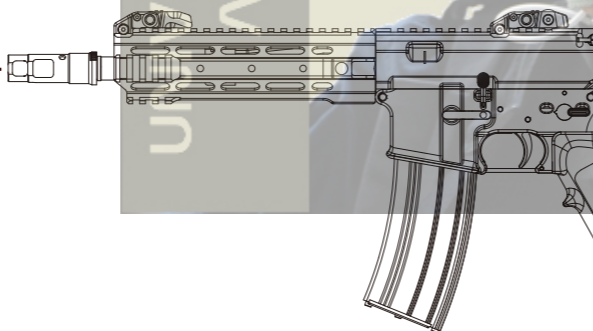
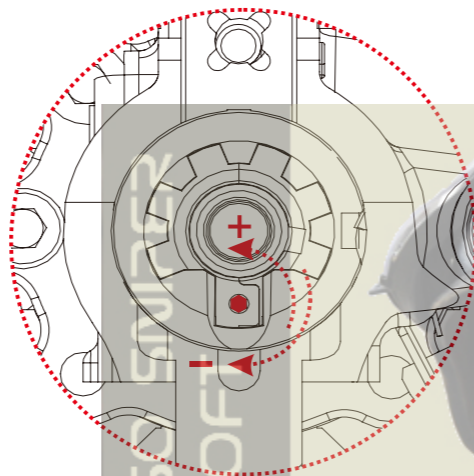
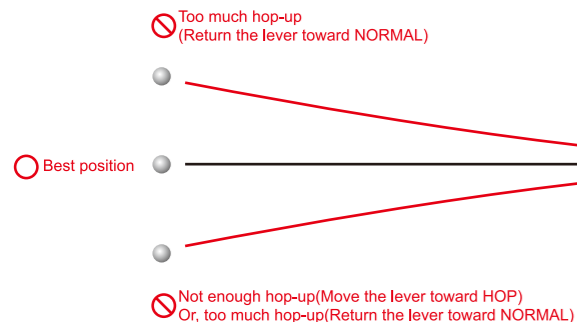

Cleaning and Maintenance

1 Lower Receiver

Lightly lubricate all moving parts inside the lower receiver.

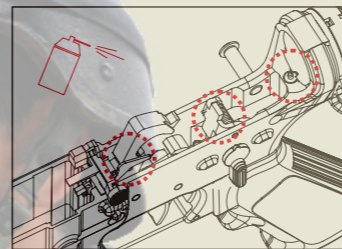

4 Magazine

Use silicone oil lightly lubricate all contact area.

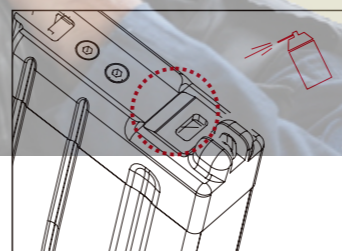

2 Upper Receiver

Clean all areas and out of fouling, Metal debris and dirt.

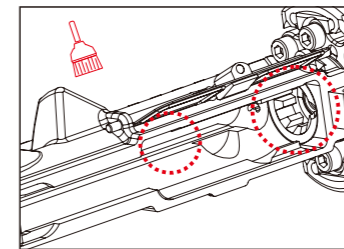

3 Bolt

Use silicone oil lightly lubricate all contact area.

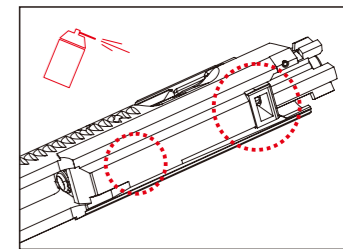

5 Inner Barrel

Use patch holder to clean the inner barrel.

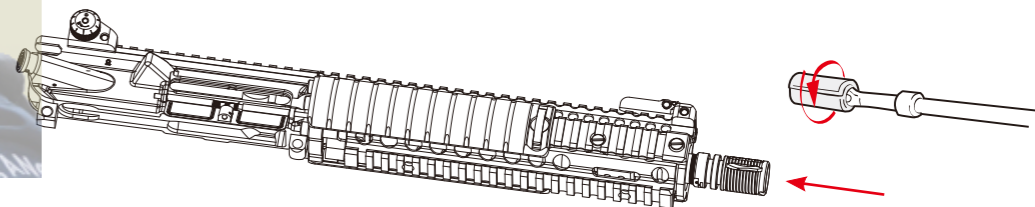

! Use silicone oil the lubrication only.
 Do not use WD-40 as lubrication.

Field Striping (e.g. MK18 MOD1)

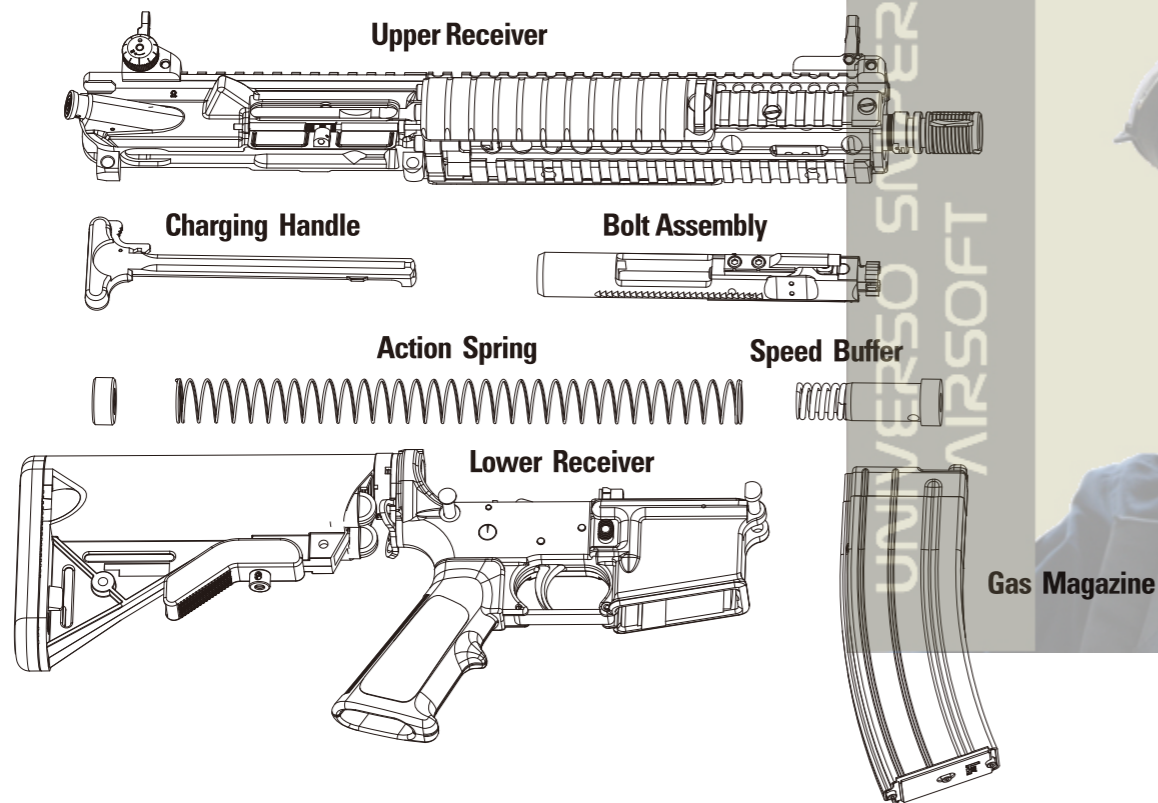

Trouble Clinic

Symptom	Cause	Action
No operation at all.	<ol style="list-style-type: none"> 1. No Gas in Magazine. 2. Selector lever on safe. 3. Not loaded. 4. The Magazine is in low temperature . 5. The pressure inside the Magazine is too high. 	<ol style="list-style-type: none"> 1. Unload the Magazine and filling the Gas. 2. Turn the selector lever on semi/ full auto sites. 3. Pull the Charging handle, loading the rifle. 4. After running fire, the Magazine will be in low temperature . Please, unload the Magazine until the Magazine temperature rise to normal. 5. Do not use GAS which pressure is surpassed 12 bl , and Do not warming the Magazine.
Magazine leak.	<ol style="list-style-type: none"> 1. O ring aged. 2. O ring broken. 3. Charging valve broken. 	<ol style="list-style-type: none"> 1. Purchase the replacement part at your dealer or from VFC. 2. Purchase the replacement part at your dealer or from VFC. 3. Purchase the replacement part at your dealer or from VFC.
The recoil force decreases.	<ol style="list-style-type: none"> 1. The Magazine is in low temperature. 2. The gas pressure is insufficient 3. Lubrication insufficiency 4. Bolt O ring broken 	<ol style="list-style-type: none"> 1. After running fire, the Magazine will be in low temperature . Please, unload the Magazine until the Magazine temperature rise to normal. 2. Unload the Magazine and refill the gas. 3. The moving part needs lubrication. 4. Purchase the replacement part at your dealer or from VFC.
The trajectory is not steady	<ol style="list-style-type: none"> 1. Too much hop setting. 2. Inner Barrel or Hop parking contaminated by oil or dirt. 3. Worn or damaged hop parking. 4. Improper or too large size BB bullets. 	<ol style="list-style-type: none"> 1. Gradually return adjustment lever towards normal. 2. Clean the oil or dirt. 3. Purchase the replacement part at your dealer or from VFC. 4. Use the quality BBs.