

MK 18 MOD 1

NEW TYPE GAS BLOW BACK SYSTEM



WARNING

Before using this GAS blowback rifle, read and follow this instruction.

1. Treat the weapon as it's always loaded.
2. Never load the weapon except you are intend to fire it.
3. Keep your finger away from the trigger.
4. Wear goggles before shooting.

MK18 MOD 1

New Type Gas Blow Back Rifle

INSTRUCTION MANUAL

CONTENTS

■ WARNING	03
■ COMPONENT NAME	04
■ SELECTOR LEVER & SAFETY SETTING	05
■ CHECK BEFORE YOU FIRE	06
■ BBS LOAD	07
■ FILLING GAS & RELEASE GAS	08
■ SETTING MAGAZINE	09
■ FIRING	10
■ VARIABLE HOP-UP SYSTEM	11
■ DISASSEMBLING	12
■ CLEANING & MAINTENANCE	14
■ ADJUST SIGHT	15
■ RAIL COVER PANELS	15
■ FRONT GRIP	15
■ CRANE SOPMOD STOCK	15
■ TROUBLE CLINIC	16
■ PARTS LIST	18



WARNING

- Before using this GAS blowback rifle, read and follow this instruction.
1. Treat the weapon as it's always loaded.
 2. Never load the weapon except you are intend to fire it.
 3. Keep your finger away from the trigger.
 4. Wear goggles before shooting.

WARNING

- Always wear eye protective gear.
- Never aim or shoot a person or animal as a target.
- You may be punished if you are shooting for practical jokes.
- Never look into the gun muzzle.
- Always direct the muzzle towards a safe direction.
- Never shoot the gun at places where people and cars pass cross.
- Avoid pulling the trigger carelessly.
- Please put away form your fingers from the trigger, except when you are ready to shoot a target.
- Always put the gun in a case or bag when you are carrying it.
- Keep out of reach of children.

WARNING

- According to the law, The VegaForceCompany's products **FOR TOY AND COLLECTION ONLY.**
- **NO MODIFY** introduction.
We also condemn any illegal activities.

■ COMPONENT NAME

LEFT SIDE

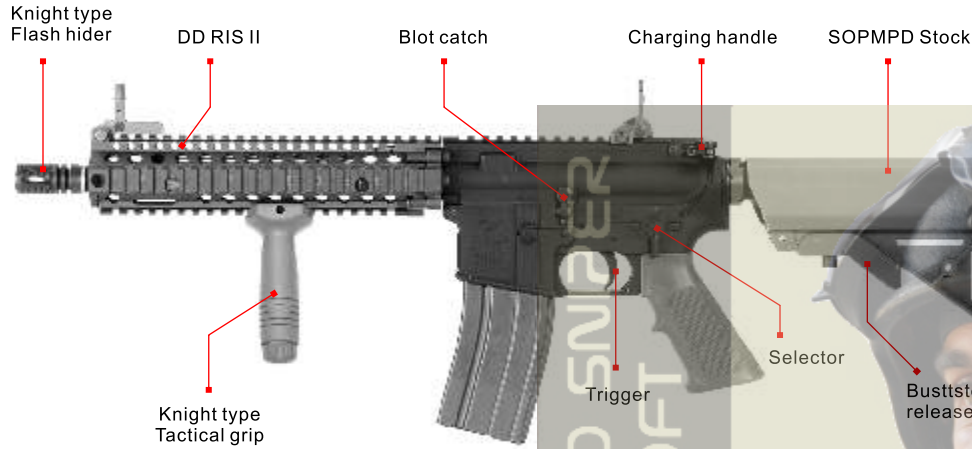

RIGHT SIDE

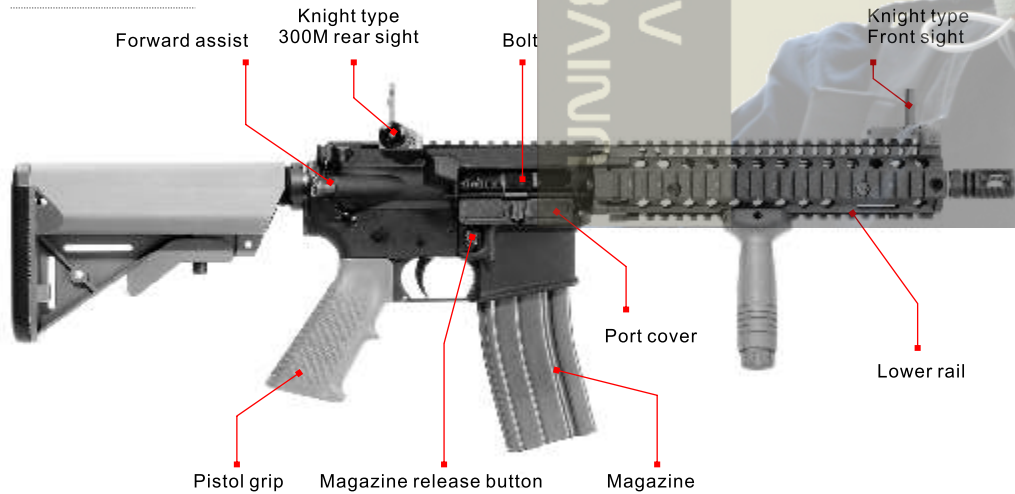

■ SELECTOR & SAFETY SETTING

LEFT SIDE



RIGHT SIDE

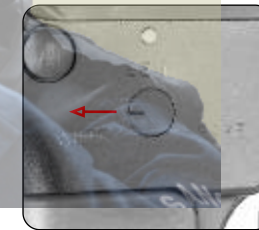
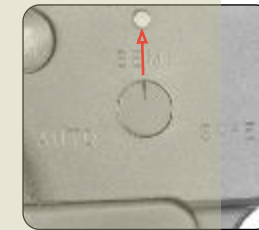
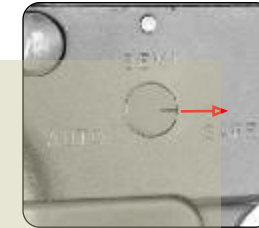

SAFETY SETTING

The trigger can not be pulled.

SEMI AUTO

Pulled the trigger, the gun will fire one shot each time.

FULL AUTO

The gun will fire automatically while the trigger remains pulled.



If the rifle is not cocked, the Safe selector Lever can not be pointed toward.

■ CHECK BEFORE YOU FIRE

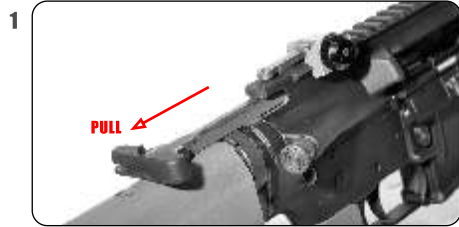

1 Lock Bolt open, pull Charging handle rearward to check that there is no BBs in the chamber, Return Charging handle to forward. If there is, please remove the BBs from the chamber. Check the Bolt and Charging handle to ensure free movement in the receiver.

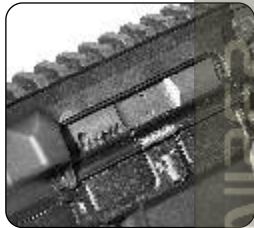
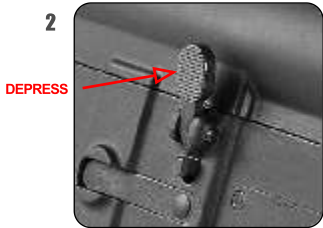

2 Depress upper portion of Bolt catch and allow Bolt to spring forward.

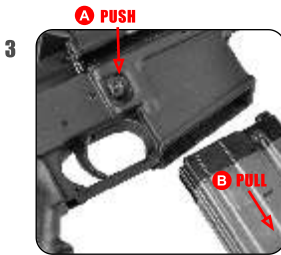

3 Press Magazine catch button and remove the magazine.



4 Point rifle in a safety direction! Place safety selector lever on safe.

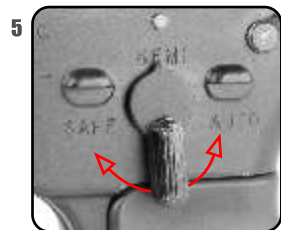

5 Perform safety function check to ensure that safety selector lever works properly.

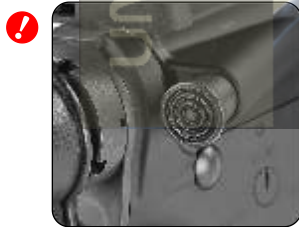

If the bolt didn't forward and lock. Please push the forward assist or pull the Charging handle several times to ensure the bolt is fully forward and locked.

■ BBS LOAD



1 BB Loader

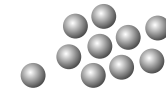

2 Insert the 6mm BBs



3 Place the adapter

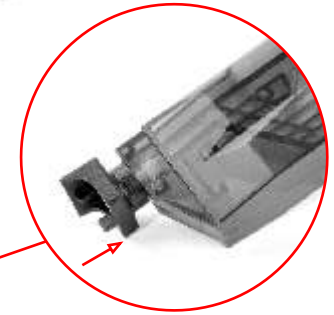

4 Insert the 6mm BBs into the Magazine. The maximum capacity is 35 rounds.

! Always use the quality BBs for this airsoft gun. we will not be held responsible for any damage and accidents arising from using of bad quality BBs.

- Diameter larger than 6mm
- No True round BBs
- Both halves not aligned
- With edges
- Used or soiled



Do not put your finger into the chamber, it's dangerous.



Do not force to over load.

■ FILLING GAS

Push the gas canister nozzle into the **Filling gas nozzle**.
Make sure the canister is in vertical position when charging.

! For the better performance of the GBB rifle.
Do not shoot the rifle right after charging the gas.

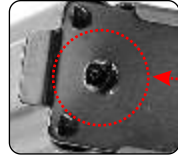

FILLING GAS NOZZLE

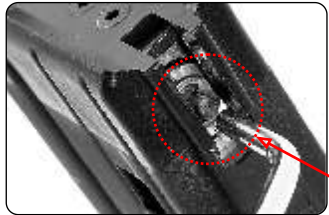

■ RELEASE GAS

Please discharge the magazine by press the value gently, for releasing residual gas.

! You may experience a delay action if the surrounding temperature drops below 20° C/68° F. Remember, do not expose magazine directly under the sun or incinerate the magazine, it may cause bursting. It is strongly recommended to empty gas from magazine after shooting. Be sure to avoid direct gas contact with Eyes or Skin when gas is being released, it will cause frostbite.

- 1. Check canister for any cracks or leaks before using.
- 2. Do not expose canister over 40° C/ 104° F.
- 3. Do not leave canister directly over fire.
- 4. Do not boil canister.
- 5. Keep canister away from direct sunlight.
- 6. Do not leave canisters inside the vehicle



■ SETTING MAGAZINE



1 Push magazine up in to magazine well. Make sure to set the magazine upwards and connect it firmly until a click sound is heard.



2 Open bolt and check firing chamber. Make sure it is clear.



3 Return charging handle to forward, locked position.

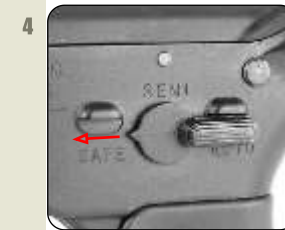

4 With the hammer cocked, please set selector lever on safe.

! Do not select to safety position if the hammer is not cooked.



5 Depress upper portion bottom to release the Bolt.



! Always point the muzzle in a safe direction.

■ FIRING

■ REMOVE LOWER RAIL & ADJUST HOP-UP

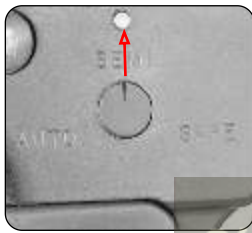
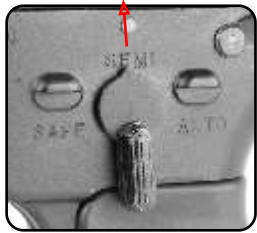

SEMI AUTO
Pulled the trigger, the gun will fire one shot each time.

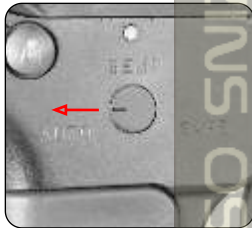
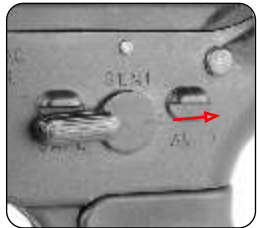

FULL AUTO
The gun will fire automatically while the trigger remains pulled.

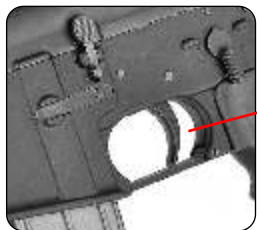

FIRING
Pull the trigger for fire BBs.

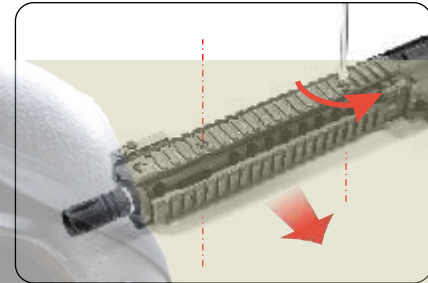
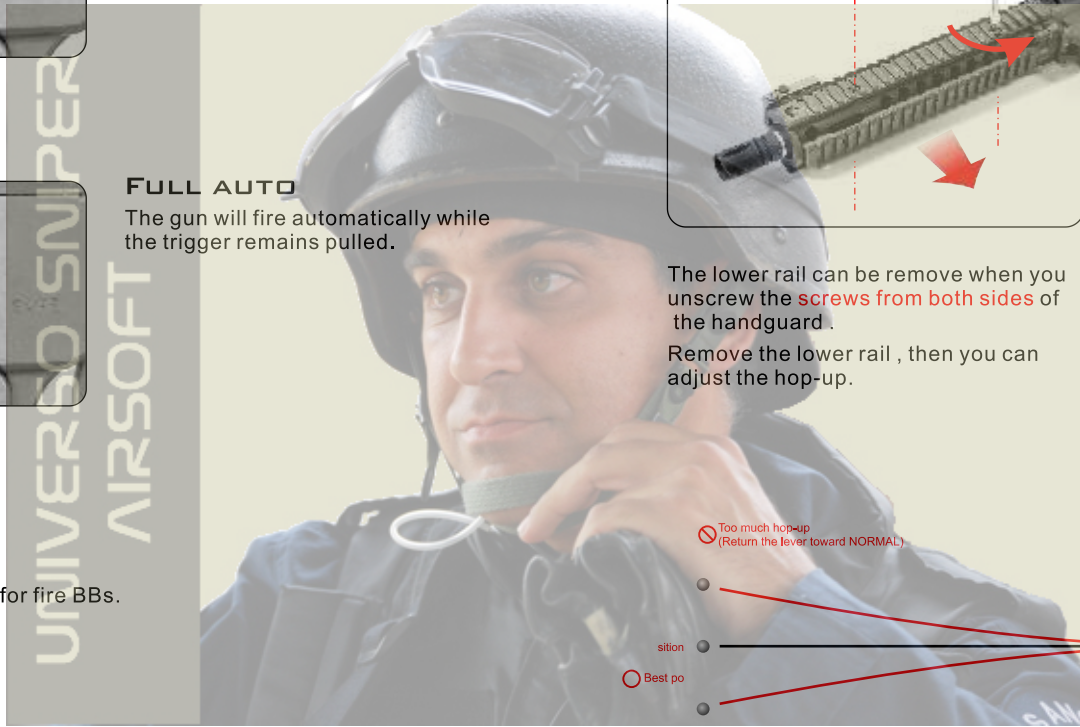

The lower rail can be removed when you unscrew the screws from both sides of the handguard. Remove the lower rail, then you can adjust the hop-up.

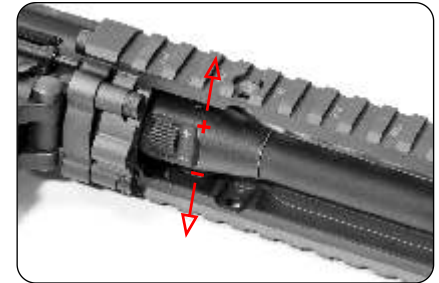

Turn the adjustment towards "+" to give bullets more hop up.

Turn the adjustment towards "-" to give bullets less hop up.

⊘ Too much hop-up (Return the lever toward NORMAL)



● Best position



⊘ Not enough hop-up (Move the lever toward HOP) Or, too much hop-up (Return the lever toward NORMAL)



GAS Blow Back rifle have heavy recoil, please handle the rifle with two hands.



Never hold the gun sideways as BB bullets will curve right or left, this is due to the HOP UP system. The Best setting is, where bullets fly horizontally.

■ FIELD STRIPPING

■ FIELD STRIPPING

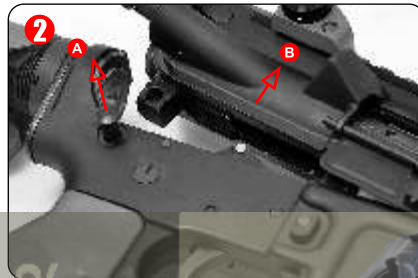

Push in Take down pin as far as it will go .
Pivot Upper receiver from lower receiver.

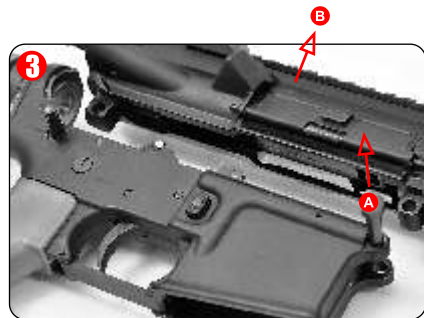

Push in pivot pin.
Separate Upper and lower receiver.



With Hammer cocked, depress buffer
retainer with punch to release buffer
and spring.

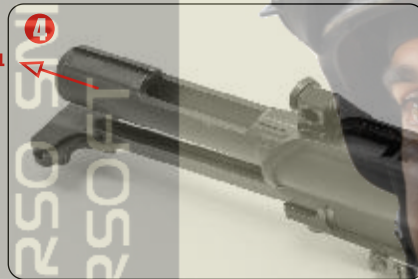

Pull back the charging handle and bolt
carrier and remove bolt carrier and blot.

! Remove Charging Handle by pulling back
and up until "Ears" clear cutouts in Receiver.

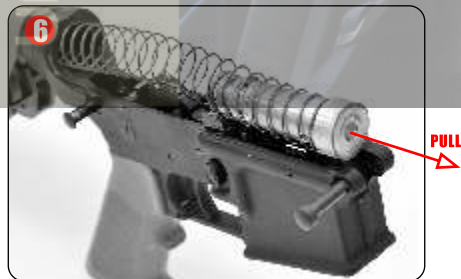

Pull out buffer and action spring.

! Buffer is under tension from action spring
Hammer needs to be cocked to allow Buffer
and Spring to clear receiver.

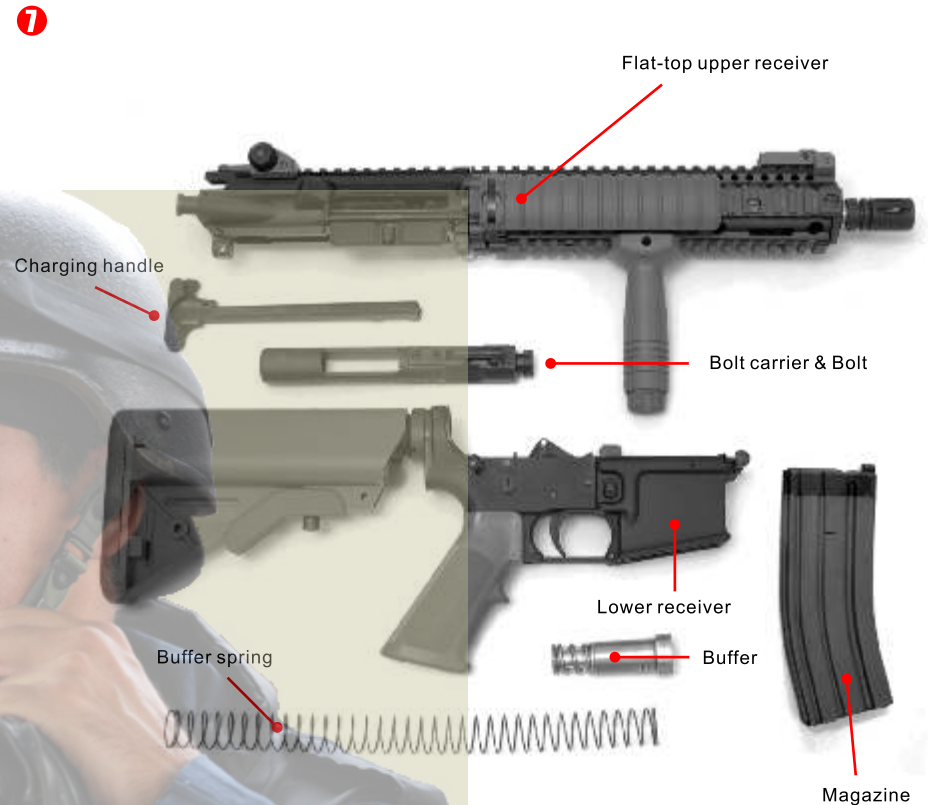

WARNING

- According to the law, The VegaForceCompany's products
FOR TOY AND COLLECTION ONLY.
- **NO MODIFY** introduction.
We also condemn any illegal activities.

■ CLEANING & MAINTENANCE

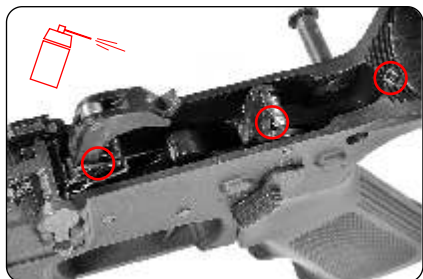

LOWER RECEIVER
Lightly lubricate all moving part inside the lower receiver.

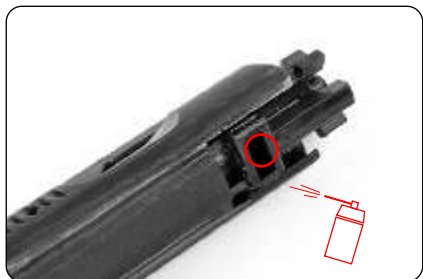

BOLT
Use silicone oil lightly lubricate all rubber contact area.

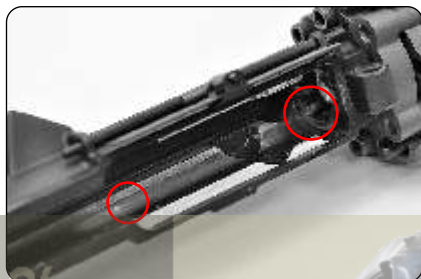

UPPER RECEIVER
clean all areas inside and out of fouling, metal debris and dirt.



MAGAZINE
Use silicone oil lightly lubricate all rubber contact area.



INNER BARREL
Use patch holder to clean the inner barrel.

■ MOVEABLE PARTS

FRONT SIGHT

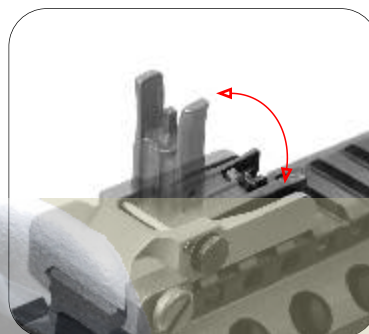

Flip it up to aim.
Depressing the detent, and then rotating Sight Post up or down as needed.

300M REAR SIGHT

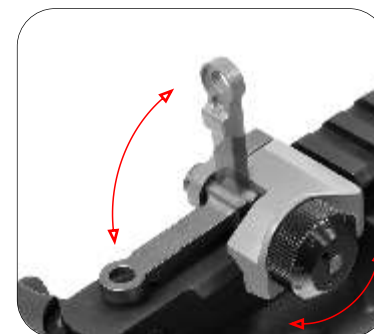

Flip it up to aim.
Rotate the windage knob forward to move the sight go right and backward go left.

RAIL COVER PANELS

Press the clip on the rail cover then you can release the rail cover by slide it forward.

FRONT GRIP

The position of the Forward grip can be adjust by unscrew the knob on the bottom of the grip.



! NOTE
Make sure the locking knob is in the right position.

CRANE SOPMOD STOCK

Push the release lever to unlock then pull the stock.
Adjust the position of stock. (5 positions)

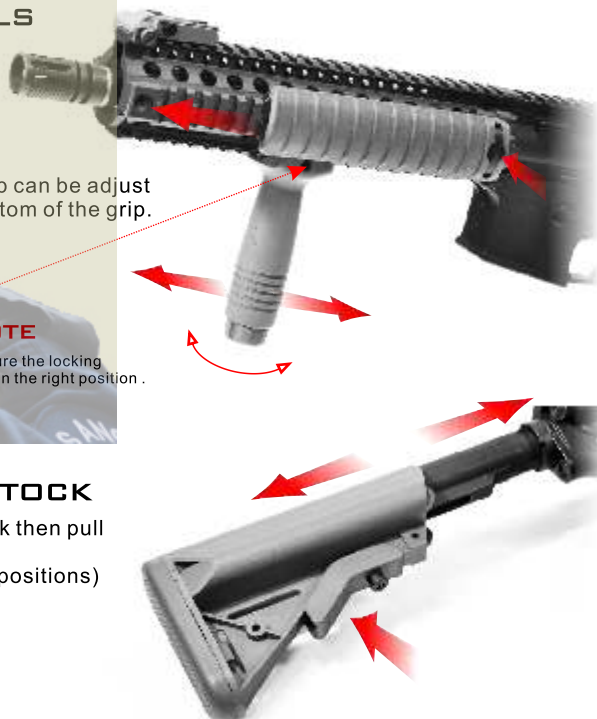

! Use silicone oil as the lubrication only.
Do not use WD-40 as lubrication.

TROUBLE CLINIC

Symptom	Cause	Action
No operation at all.	<ol style="list-style-type: none"> 1. No Gas in Magazine. 2. Selector lever on safe. 3. Not loaded. 4. The Magazine is in low temperature . 5. The pressure inside the Magazine is too high. 	<ol style="list-style-type: none"> 1. Unload the Magazine and filling the Gas. 2. Turn the selector lever on semi/ full auto sites. 3. Pull the Charging handle, loading the rifle. 4. After running fire, the Magazine will be in low temperature . Please, unload the Magazine until the Magazine temperature rise to normal. 5. Do not use GAS which pressure is surpassed 12 bl , and Do not warming the Magazine.
Magazine leak.	<ol style="list-style-type: none"> 1. O ring aged. 2. O ring broken. 3. Charging valve broken. 	<ol style="list-style-type: none"> 1. Purchase the replacement part at your dealer or from VFC. 2. Purchase the replacement part at your dealer or from VFC. 3. Purchase the replacement part at your dealer or from VFC.
The recoil force decreases.	<ol style="list-style-type: none"> 1. The Magazine is in low temperature. 2. The gas pressure is insufficient 3. Lubrication insufficiency 4. Bolt O ring broken 	<ol style="list-style-type: none"> 1. After running fire, the Magazine will be in low temperature . Please, unload the Magazine until the Magazine temperature rise to normal. 2. Unload the Magazine and refill the gas. 3. The moving part needs lubrication. 4. Purchase the replacement part at your dealer or from VFC.
The trajectory is not steady	<ol style="list-style-type: none"> 1. Too much hop setting. 2. Inner Barrel or Hop parking contaminated by oil or dirt. 3. Worn or damaged hop parking. 4. Improper or too large size BB bullets. 	<ol style="list-style-type: none"> 1. Gradually return adjustment lever towards normal. 2. Clean the oil or dirt. 3. Purchase the replacement part at your dealer or from VFC. 4. Use the quality BBs.

NOTE

 If you have any other states, please contact with your dealer or write e-mail to us via support@gb-tech.com.tw

PARTS LIST

- 01 VF9-FHR-KAC-01
KAC TYPE FLASH HIDER
- 02 VF9-WSR-M4-105
PEEL WASHER 105
- 03 VF9-GBK-KAC-01
KNIGHT GAS BLOCK
- 04 VF9-FST-KAC-TN01
KAC TYPE FLIP-UP FRONT SIGHT (TAN)
- 05 VF9-RST-300M-TN02
KAC TYPE 300M FLIP-UP REAR SIGHT (TAN)
- 06 VF9-MWS-FG-TN02
KAC TYPE FRONT PISTOL GRIP(TAN)
- 07 VF9-MWS-RP-TN11
11 RIBS RAIL COVER PANEL(TAN)
- 08 VF9-HGD-DDRIS2-TN01
DANIEL DEFENSE RIS II
- 09 VF9-GPN-M4-210
GAS TUBE
- 10 VF9-HOP-M4G-01
HOP-UP RUBBER FOR M4 GBBR
- 11 VF9-HOP-M4G-02
M4 GBBR HOP-UP BASE
- 12 VF9-BRL-IN360-01
275MM INNER BARREL
- 13 VF9-BRL-M4G105-ST01
STEEL 10.5" OUTER BARREL
- 14 VF9-DCR-M4G-01
PORT COVER
- 15 VF9-FAA-M4G-ZN
M4 FORWARD ASSIST ASSEMBLY
- 16 VF9-URV-M4G-BK01
UPPER RECEIVER FOR M4 GBBR
- 17 VF9-NOZ-M4G-02
M4 LOADING NOZZLE SET
- 18 VF9-BLT-M4G-ZN01
M4 BOLT CARRIER
- 19 VF9-NOZ-M4G-01
M4 NOZZLE GUIDE
- 20 VF9-CHA-M4G-AL01
CHARGING HANDLE ASSEMBLY
- 21 VF9-PIN-M4G-01
M4 GBBR FRONT PIVOT PIN SET
- 22 VF9-TGR-M4G-ST01
STEEL TRIGGER SET
- 23 VF9-HMR-M4G-ST01
M4 GBBR STEEL HAMMER & DISCONNECTOR SET
- 24 VF9-ASR-M4G-01
M4 GBBR AUTO SEAR
- 25 VF9-PIN-M4G-02
M4 GBBR TAKE DOWN PIN SET
- 26 VF9-LRV-M4G-BK01
M4 GBBR LOWER RECEIVER
- 27 VF9-TGD-M4G-01
M4 GBBR TRIGGER GUARD
- 28 VF9-MCH-M4G-ST01
STEEL MAGAZINE CATCH SET
- 29 VF9-MSY-M4G-ST01
STEEL SELECTOR LEVER SET
- 30 VF9-BFT-M4G-BR
BUFFER RETAINER SET

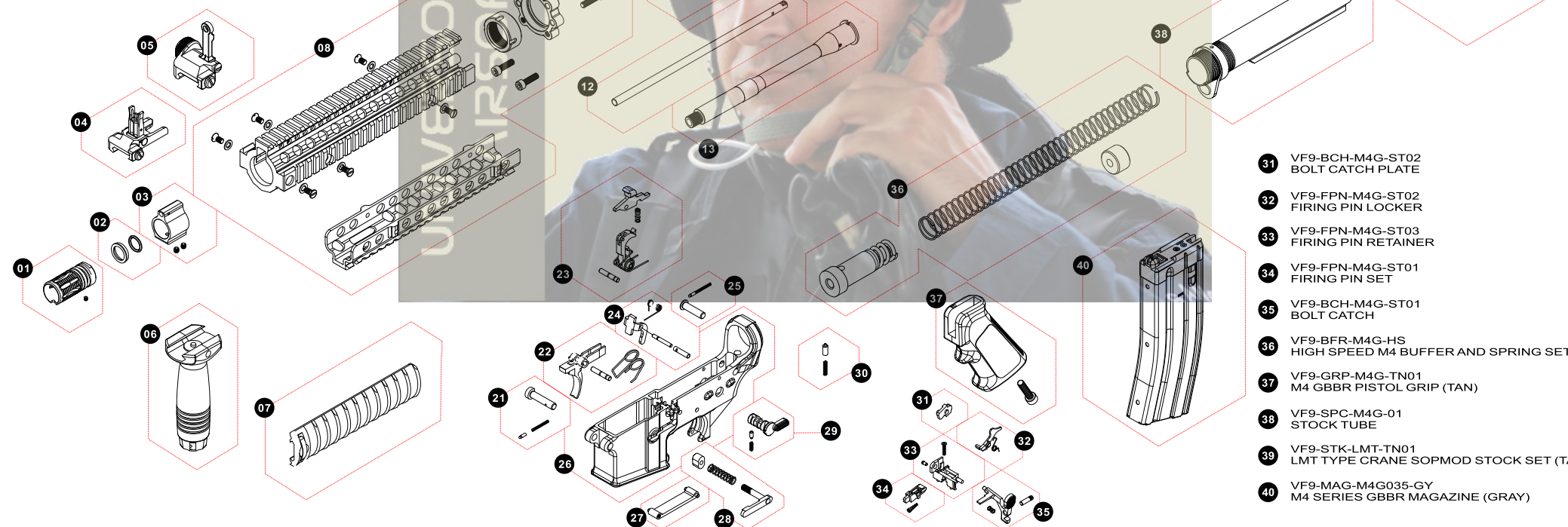

- 31 VF9-BCH-M4G-ST02
BOLT CATCH PLATE
- 32 VF9-FPN-M4G-ST02
FIRING PIN LOCKER
- 33 VF9-FPN-M4G-ST03
FIRING PIN RETAINER
- 34 VF9-FPN-M4G-ST01
FIRING PIN SET
- 35 VF9-BCH-M4G-ST01
BOLT CATCH
- 36 VF9-BFR-M4G-HS
HIGH SPEED M4 BUFFER AND SPRING SET
- 37 VF9-GRP-M4G-TN01
M4 GBBR PISTOL GRIP (TAN)
- 38 VF9-SPC-M4G-01
STOCK TUBE
- 39 VF9-STK-LMT-TN01
LMT TYPE CRANE SOPMOD STOCK SET (TAN)
- 40 VF9-MAG-M4G035-GY
M4 SERIES GBBR MAGAZINE (GRAY)