

警告

 限使用12kg瓦斯
(R22 / Green gas)

 請勿接近火源
(Never place it near fire)

 嚴禁存放於高溫環境
(Never store the Magazine above 40°C)

 請勿烈日曝曬
(Never place it directly under sunshine)

Caution!

VORSICHT

PRECAUTION

Ausschliesslich für diese Pistole bestimmte

NE PAS UTILISER D'AUTRES

Munition verwenden.(5.5mm Kunststoffkugeln)

PROJECTILEE QUE CEUX FOURNIS.

Fare attenzione

射擊時最好戴護目鏡

Be sure to wear shooting glasses or Goggle when shooting.

Toujours porter des lunettes de tir ou de protection quand vous tirez.

Zum Schiessen stets eine Schutzbrille tragen.

Asegúrese de llevar puestas las gafas de protección cuando dispara.

Assicurarsi di indossare lenti di Protezione quando si spara



不用時要把槍置於高處 (小孩拿不到的高處)

Put the gun beyond the reach of kids.

Tenir hors de portee des enfants.

Pistole immer kindersicher aufbewahren.

Ponga la pistola fuera del alcance de los niños.

Tenere fuori Dalla portata dei bambini.



不可用眼睛探視槍

Don't peep at the muzzle.

Ne jamais regarder dans le canon.

Nie in den lauf schauen.

Jamas mire por el canon

Non guardare mai dentro la canna.



不可朝人射擊

Don't aim at people even if it is unloaded.

Ne jamais viser quelqu'un meme si votre pistolet est vide.

Auch bei spiel-und Sportwaffen besteht Verletzungsgefahr. Auch ungeladen nie auf einen Menschen oder ein Tier richten!

No apunte a personas, incluso descargado.

Non puntare mai verso le persone anche se la pistola scarica.



射擊的瞬間，才可以把手指接近扳機擊扣

Don't touch the trigger until the moment of shooting.

Ne jamais appuyer sur la gachette le rearment.

Abzug erst dann berühren,wenn Sie zum Schiessen bereit sind.

No toque el gatillo hasta el momento del disparo.

Non toccare il grilletto fino al momento di sparare.



確定射擊的方向均安全後才可以射擊

After making sure that there is nobody nearby.

Toujours etre sur qu'il n y a personne dans la trajectoire de votre tir.

Vergewissern Sie sich vor dem Schiessen stets, dass niemand getroffen werden kann.

Antes de apuntar aseguese que no hay nadie cerca.

Assicurarsi sempre che non ci sia nessuno sulla traiettorria di tiro.



避免粗魯的動作，發生危險

Avoid a rough operation.

Ne jamais jeter le pistolet quand il est arme.

Geladene Waffe stets mit Respekt Behandln. Nicht werfen oder unsanft Jandhaben.

No tire ni lance la pistola, se puede disparar.

Evitare azioni brusche.



不使用時，應將彈匣取出，並取下子彈

When the gun is not in use, remove the magazine and unload BB pellets.

Quand vous ne l'utilisez plus,bien Faire attention de retirer le chargeur et de le desarmer.

Zum Aufbewahren Magazin entfernen und Kugeln herausnehmen.

Cuando no se este utilizando la pistola, saque todas las bolas.

Quando l'arma non e in uso, estrarre il caricatore e scaricare i pallini.



★正確使用空氣軟槍,可享受愉快的射擊,但是錯誤的使用方法非常危險,務必遵守注意事項.

Miss handle the airsoft gun may condition serious injure or death. Please read the safety instruction before use.



INSTRUCTION MANUAL

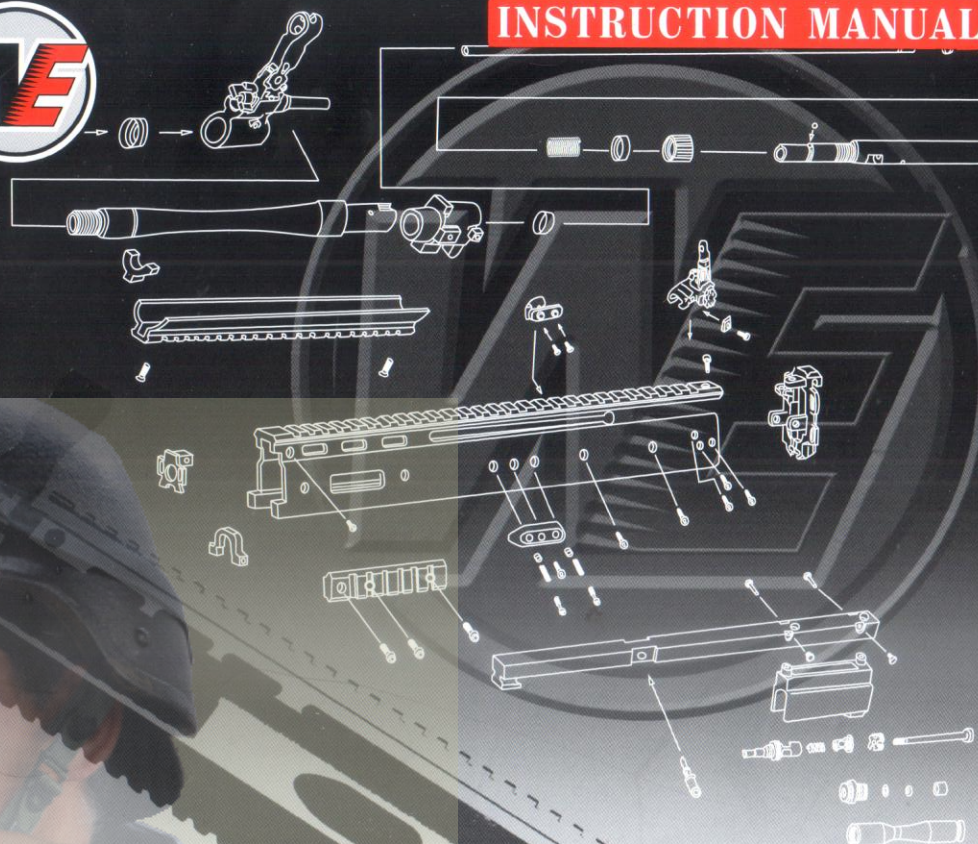

刀炮

GAS BLOWBACK TYPE

FOR AGE 18 YEARS OR OLDER

MADE IN TAIWAN

① 各部名稱 NAME OF PARTS



② 彈匣裝填 MAGAZINE LOADING

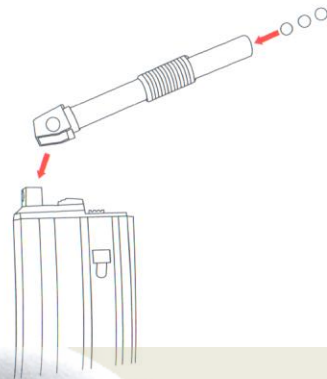

將6MMBB彈裝填入附贈的填彈器中
Fill 6mm BBs with loader.

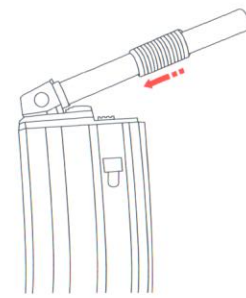

將彈匣入彈口插入填彈器壓下填彈桿裝入BB彈到滿
Push loading rod 6 times to fill around 30 Bbs into the magazine.



將瓦斯由底版注入孔灌入
Fill gas from bottom of magazine.
※限使用12kg 瓦斯 (R22/Green Gas)

③ 槍枝上膛發射前準備 PREPARE FOR SHOOTING

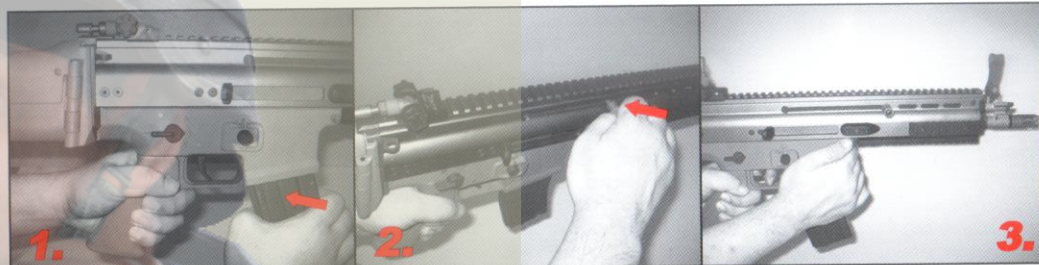

1. 插入充填完BB彈與瓦斯的滿彈匣
Insert the loaded magazine into the lower receiver.

2. 拉拉柄向後到底後,快放確認槍機復位上膛
Pull the charging handle and quick release to loading the BBs.

3. 瞄準目標,開始射擊
Aiming target and ready to shoot.

④ 照門使用 REAR SIGHT OPERATE

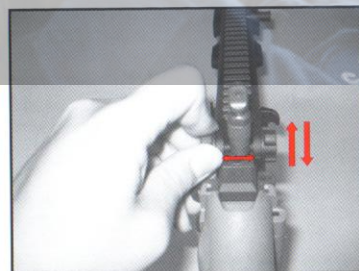

後照門可以直接立起或摺疊,會自動定位,左右調整鈕用以調整彈著群左右誤差
The rear sight able to stand or fall. Turn the button on both side for windage adjustment.

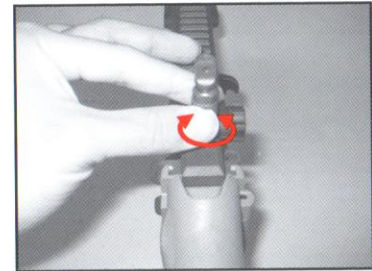

如彈著群偏高或偏低,可以調整照門柱上高低調整環
Turn the dial for elevation zeroing.

5 槍枝大部分分解 FIELD STRIP



卸除彈匣。拉拉柄確認無殘留BB彈在槍腔內，關保險
Remove the magazine. Pull the charging handle to lock the hammer and turn the fire selector to SAFE(S) position.

由左側推出下槍身結合銷
Pull the charging handle back around 2cm and push the lower receiver locking pin out.

向下向前拉出下槍身
Pull out the lower receiver from front.



向下方拉下槍托總成
Push the butt stock from top to remove.

取出復進簧連桿
Remove the recoil spring module.

向後拉拉柄至圍孔處向外抽出拉柄
Pull the charging handle to the end.



取出拉柄並倒出槍機
Take the charging handle out.

取出槍機
Remove the bolt carrier module.

使用梅花扳手轉開左右側槍管結合螺絲
Use the star key tools(Gas regulator) to remove the barrel fixed (star) screw on front of both side rail.



使用梅花扳手轉開左右側槍管結合螺絲
Remove the two barrel fixed (star) screw on both side middle of upper receiver.

向前向上分離槍管總成
Push forward the barrel sets forward 4.5 cm and pull up to take out the barrel sets.

大部分分解完成(反向即可組裝恢復)
Complete.(Please reverse step to complete installation)

*S: The barrel sets disassemble on step 9-12 are for experienced player, not recommend for newbie.

槍托收摺 Folding Stock

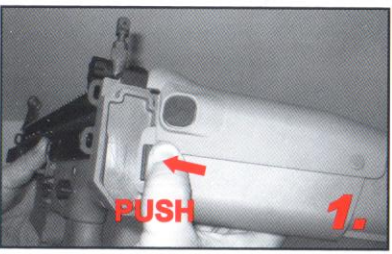

按下固定鈕解除槍托卡筭
Push the stock release button.

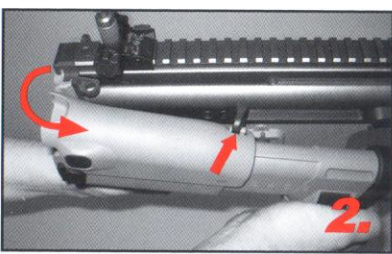

向下收摺槍托卡合於槍身右側卡筭固定
Folding the stock and locking the but stock.

槍托長度調整 Butt Stock Extent

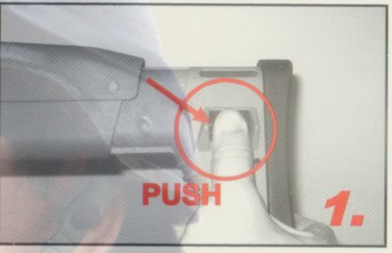

向下壓下槍托調整鈕解除鎖定便可拉出或推入槍托
Push the button on left side of stock.

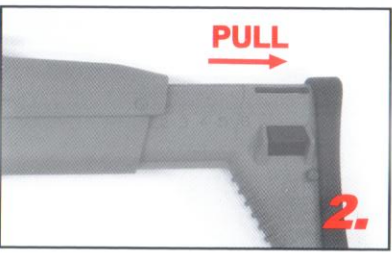

槍托共有六段伸縮段位可以調整
Pull the stock to the 1-6 position and release the button to lock.

準星摺疊 Folding Front Sight

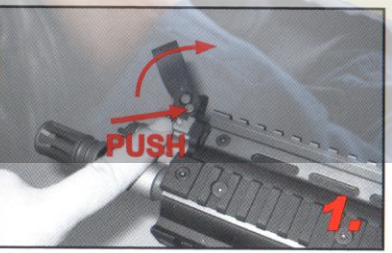

按下左側卡筭鈕，準星方能立起或向前摺疊
Push the button on left of front sight to fall or stand the front sight.



立起或摺疊位置定位正確時，準星卡筭都會自動彈起鎖定準星
The button will be auto-lock when the sight on the position.

彈匣卡筭 Ambidextrous Magazine Release

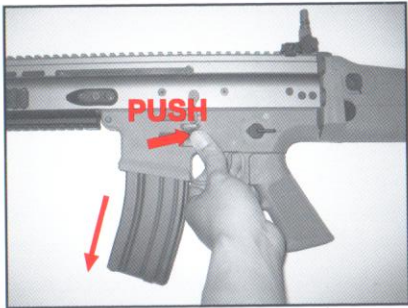

左側使用彈匣卡筭(壓下彈匣卡筭,彈匣即脫落)
Push the magazine release button on left side for left hand shooter.

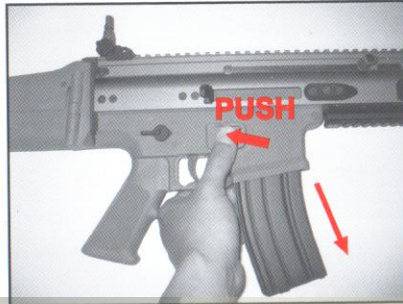

右側使用彈匣卡筭(壓下彈匣卡筭,彈匣即脫落)
Push the magazine release button on right side for right hand shooter.

射擊選擇鈕 Ambidextrous Fire Selector



左側位置
The selector button on left side for left hand shooter.

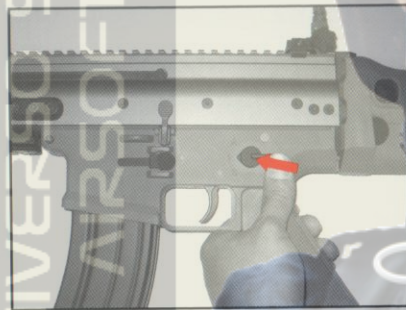

右側位置
The selector button on right side for right hand shooter.

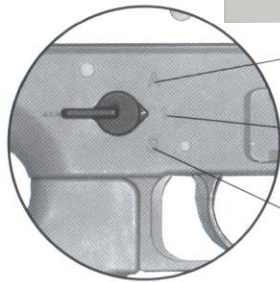

全自動射擊模式
Full-Auto Mode

半自動射擊模式
SEMI-Auto Mode

保險模式
Safty Mode

爆炸圖 (OPEN-BOLT)
EXPLOSION

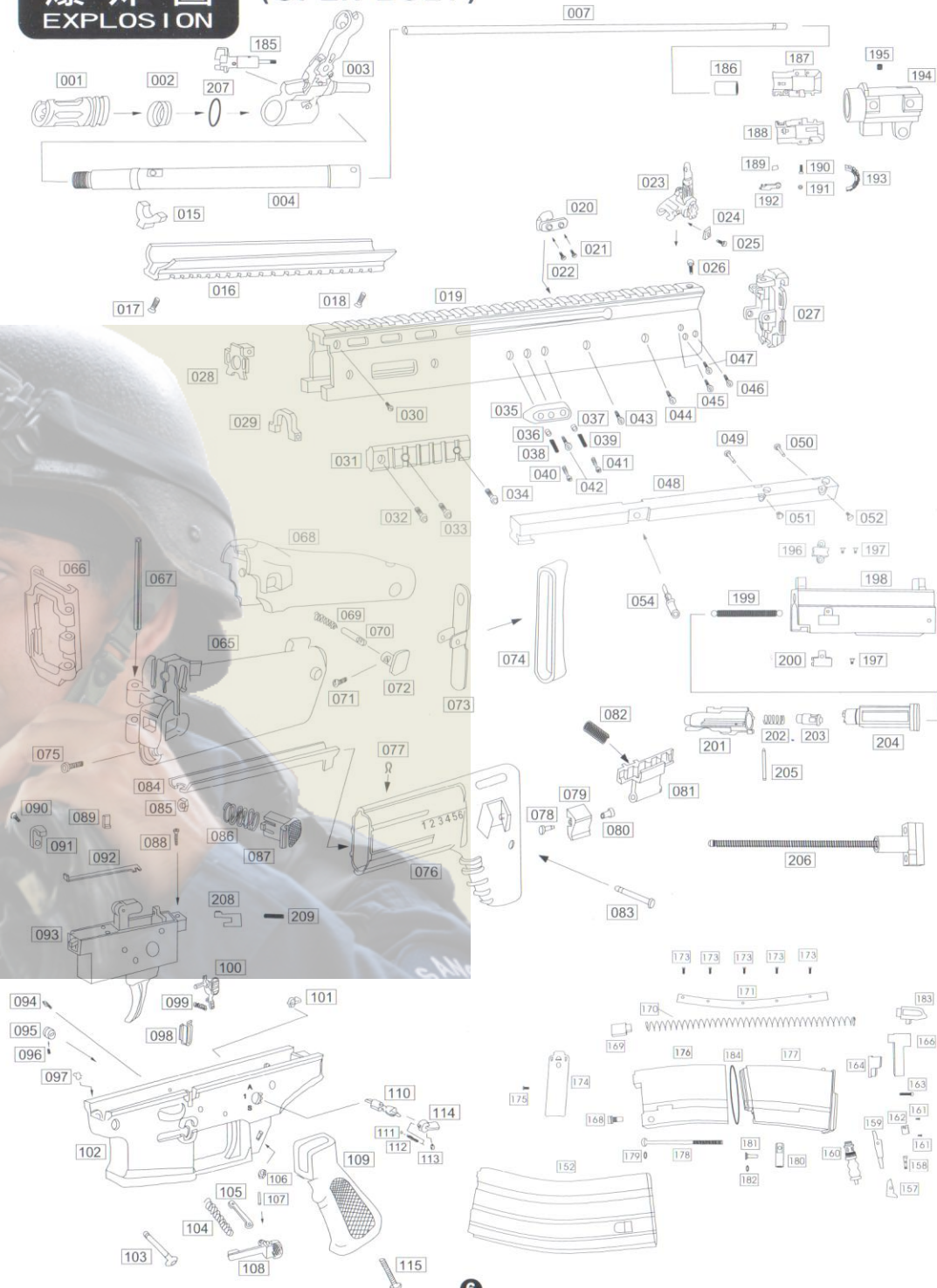

刀疤-H

零件表

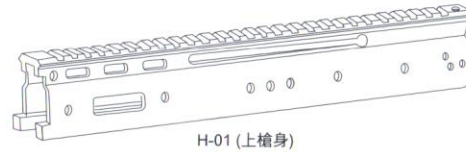

H-01 (上槍身)

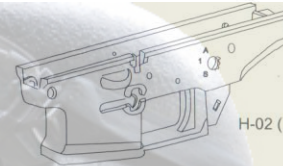

H-02 (下槍身)



H-03 (槍機組)

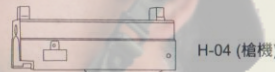

H-04 (槍機)



H-05 (內管337)



H-06 (覆進蓋)

H-07 (槍托結合座)

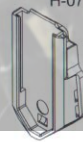

H-08 (射擊選擇鈕-右)

H-09 (射擊選擇鈕-左)

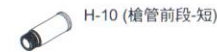

H-10 (槍管前段-短)

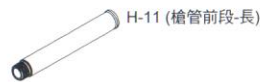

H-11 (槍管前段-長)



H-12 (防火帽)

H-14 (退彈鈕)

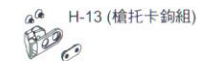

H-13 (槍托卡鉤組)

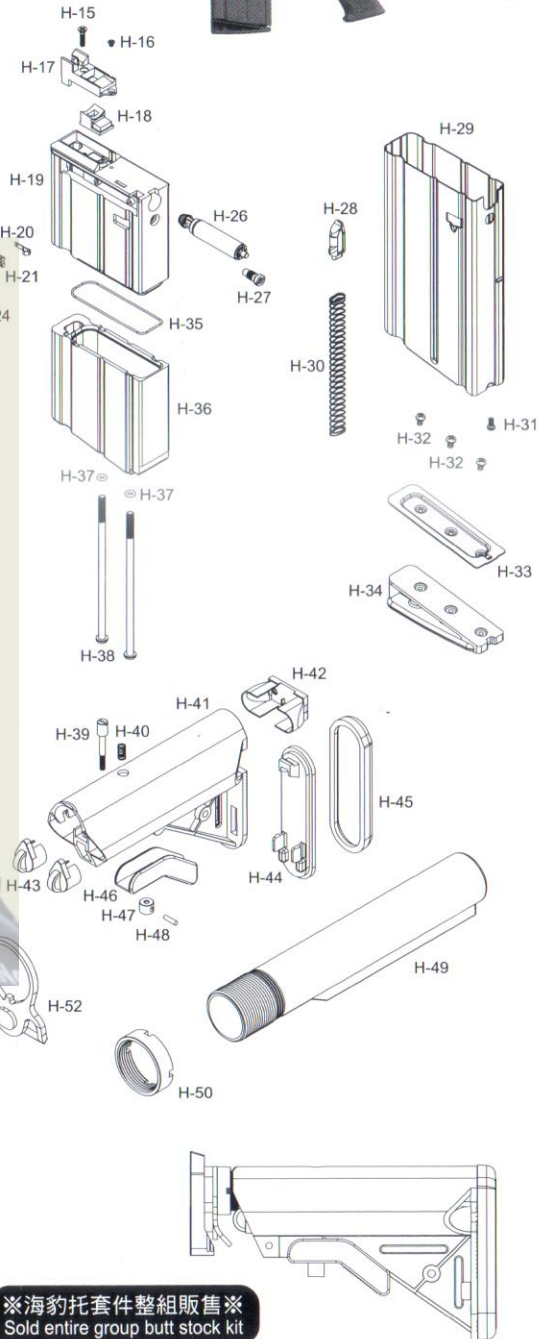

UNIVERSO SNIPER
AIRSOFT



※海豹托套件整組販售※
Sold entire group butt stock kit