

HANDLING CAUTIONS AND INSTRUCTION MANUAL

SVD



Precision Spring Rifle

User restricted to 18 years of age or older

Warning

Always read through this manual before operation.



Content

	page
1) Outlook / Structure of SVD 2) Specification 3) Operation	1
4) Magazine Attachment / Detachment Procedure	2
5) Sight adjustment 6) How to detach / attach the cheek pad.	3
7) How to detach / attach the top cover. 8) Hop up system adjustment 9) How to fire	4
10) Warning	5

WARNING

Never point the muzzle at people or animals.

Please keep the rifles far away from children.

Don't try to look at the muzzle directly.

Always detach the magazine and battery from the gun before storage.

Don't hang your finger on the trigger if you are not shooting.

Always use new pellets with high quality. Never use pellets that has already been fired.

Never load the rifle if you don't intend to fire it.

Please remember to wear protective glasses or shooting glasses to protect the eyes.

SVD Spring Rifle

1 Outlook / Structure of SVD

Always set the selector switch to the safe position when you are not firing or during storage

SVD Spring Rifle

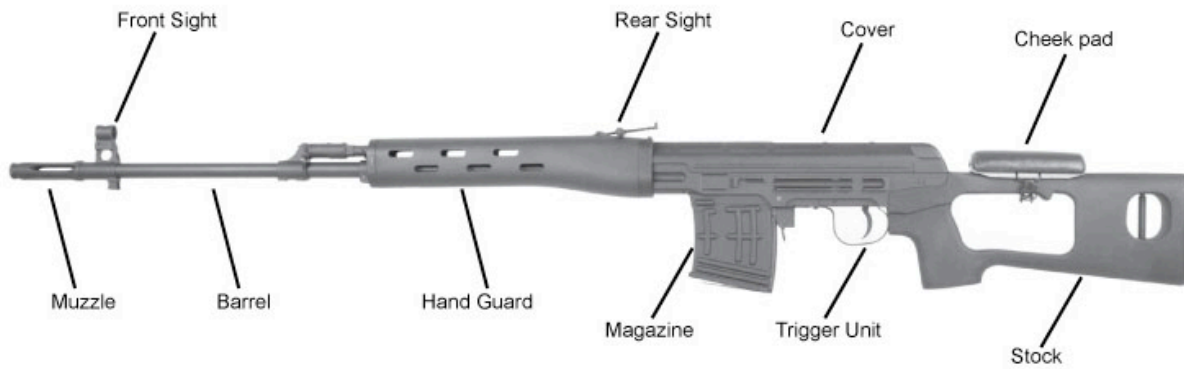

2 Specification

Name	SVD Spring Rifle		
Weight	3.3 kg	Pellet Capacity	200 rd
Barrel Length	631 mm	Pellet	6mmBB
Barrel Caliber	6.08 mm	Pellet Speed	85~130 fps

3 Operation

How to use safety lock

Safety Lock

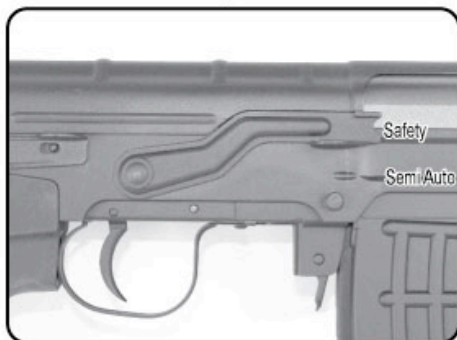

Semi Auto



4 Magazine Attachment / Detachment Procedure

Magazine Attachment

Always set the magazine upward.
Align the groove shown by an arrow and press the rear of the magazine.

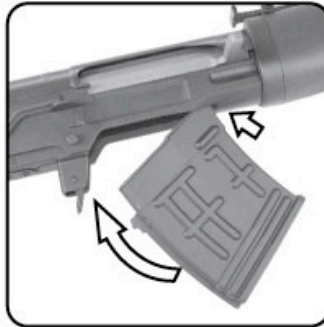

Detachment Procedure

Press the magazine release lever to remove the magazine.

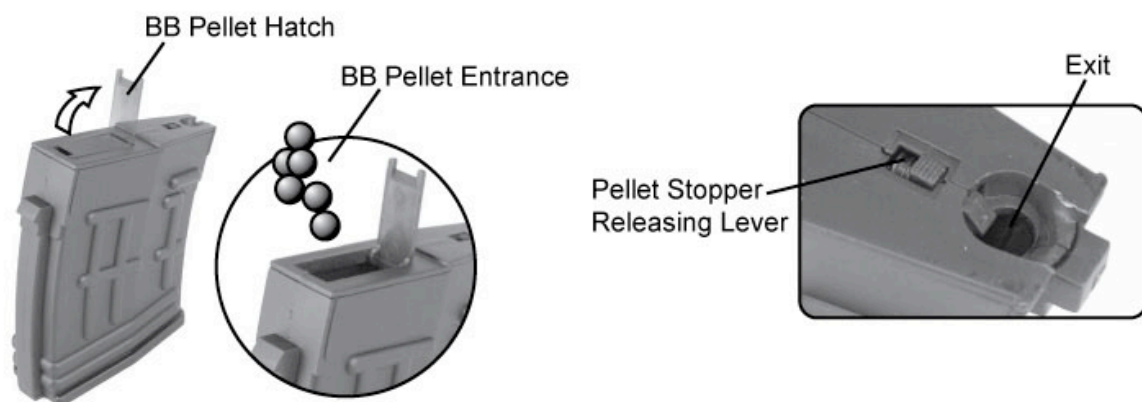

Open the BB pellets hatch and insert BB pellets. About 200 pellets can be loaded.
(Avoid forcing BB pellets into the magazine.)

SVD Spring Rifle

5 Sight adjustment

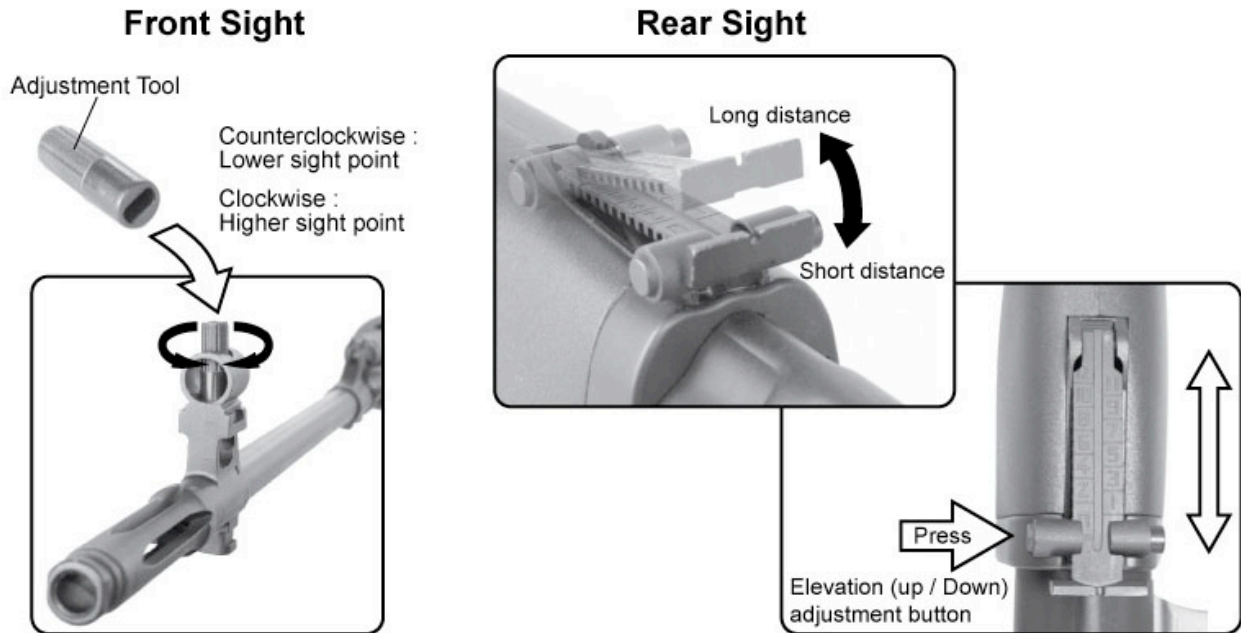

Insert the front sight adjustment tool in the front sight and turn it for adjustment.

6 How to detach / attach the cheek pad.

To detach the cheek pad, unlock the hook.

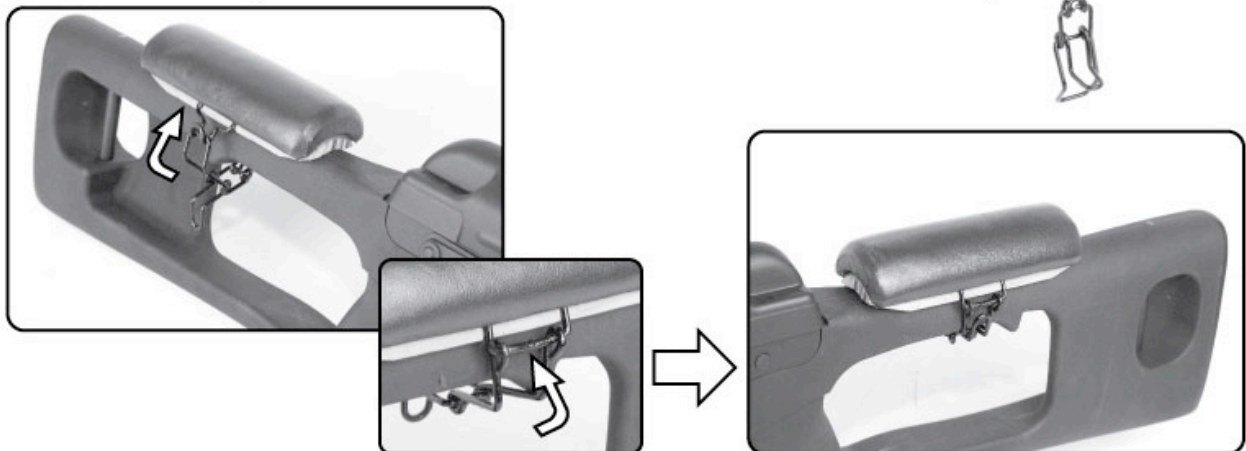

To attach the cheek pad, lock the hook.

7 How to detach / attach the top cover.



Press the release button to remove the cover.



Place the cover back and lock the release button.

8 Hop up system adjustment

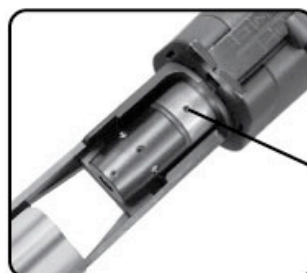

Adjust hop up.

CAUTION Pull the cocking lever until Hop Up system can be seen.

CAUTION Turn it excessively will adversely affect the trajectory. Stop turning it when pellets shoot horizontally.

9 How to fire

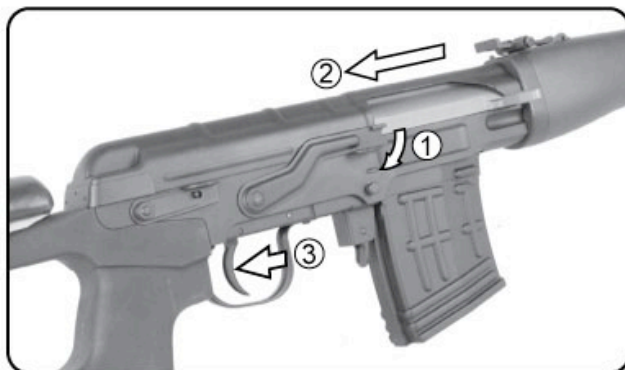

- 1) Switch the selector switch to Semi Auto.
- 2) Pull the cocking lever until "Click" sound is heard.
- 3) Pull the trigger.

CAUTION The hop up operation may be unstable for 200 to 300 pellets after using silicone oil, this is the normal operation of the gun.

When pellets are clogged If pellets are clogged, remove them and apply a few drops of silicone oil into the chamber from the magazine entrance as shown or spray silicone oil for 0.5 to 1 sec, to obtain smooth continuous firing (Never use CRC-556 or other mineral oil).



<http://www.akairsoft.com>