

KWC®
SINCE 1978

KIEN WELL TOY INDUSTRIAL CO., LTD

NO. 89, LN. 168, YILIN RD., RENDE DIST., TAINAN CITY 71752, TAIWAN (R.O.C)

TEL : +886-6-2798175 • FAX : +886-6-2798176

WWW.KWCGUN.COM • EMAIL : sales@kwcgun.com



K08-00820



KWC



2020 PRODUCT CATALOG +
THE BEST SHOOTING GEAR

HISTORY

- 1978 Found in 1978, Shun-Chi Huang found Kien Well Toy Industrial Company in Tainan, the south part of Taiwan. It was first established in Huang's house with around 10 workers. We start off as a toy manufacturer and the most famous product is our matchbox car.
- 1987 with supporting from Taiwan Toy Manufacturers Association (TTMA), KWC starts to import computerization management. We are also one of the first few toy manufacturers successfully integrate computer system at work place.
- 1989 the company cooperates with top Japan airsoft producer and switch business direction from toy manufacturing to airsoft production.
- 1992 our 1911 spring pistols is a great hit in Japan market. Then the following year, we launch four more spring pistol series.
- 1993 with years of experience in airsoft industry, Shun-Chi Huang teams up with several Taiwanese airsoft manufacturers and establishes Taiwan Airsoft Development Association. He is also elected as the first and second chairman of the association.
- 1995 KWC launches our first gas blowback replicas.
- 1997 KWC is the first ISO 9002 certified airsoft manufacturer in Taiwan. We also launches gas revolver replicas at the same year.
- 2004 We introduce our first mid-size sub-machine gun replica with gas blowback system.
- 2007 We start to work on non-blowback CO2 replicas. The CO2 replicas are more reliable, shoot harder and last longer than gas. It is also known for better performance in cooler temperature.
- 2008 KWC launch our first CO2 blowback pistol—KCB12. Afterwards we successfully turn several other gas pistol into CO2 power replicas.
- 2010 KWC introduces full metal CO2 blowback 1911. This has right away makes it to most popular replicas of all time.
- 2012 To keep up with increasing demand of Airgun and airsoft, KWC expands our factory in a new location.
- 2014 As an ethical supplier of WalMart, KWC successfully passes the ES audit. This promote our products to all customers thru over 11,000 WalMart stores in the USA.
- 2015 KWC establishes a new headquarter in Tainan, Taiwan. As our goal of continuing growth and improvement, we strive for best quality products.

CONTENT

■ BLOW BACK

MODEL 54 SERIES	02	MODEL 15 SERIES	14
MODEL 51 SERIES	03	MODEL 41 SERIES	15
MODEL 19 SERIES	04	MODEL 18 SERIES	16
MODEL 20 SERIES	05	MODEL 07 SERIES	17
MODEL 48 SERIES	06-07	MODEL 88 SERIES	18
MODEL 23 SERIES	08	MODEL 89 SERIES	19
MODEL 46 SERIES	09	MODEL 44 SERIES	20
MODEL 77 SERIES	10-11	MODEL 74 SERIES	21
MODEL 76 SERIES	12-13	MODEL 12 SERIES	22

■ NON-BLOW BACK

MODEL 44 PELLET SERIES	23	MODEL 43 SERIES	32
MODEL 46 PELLET SERIES	24	MODEL 44 SERIES	33
MODEL 76 PELLET SERIES	25	MODEL 45 SERIES	34
PELLET REVOLVER SERIES	26-27	MODEL 55 SERIES	35
REVOLVER SERIES	28-29	MODEL 46 SERIES	36
MODEL 40 SERIES	30	MODEL 47 SERIES	37
MODEL 42 SERIES	31	MODEL 48 SERIES	38-39

■ SPRING GUN

SPRING AIRSOFT SERIES	03, 36-43	MODEL M4 SERIES	46-47
SPRING AIRGUN SERIES	44-45		

■ ACCESSORIES

ACCESSORIES	48-49
-------------------	-------

UNIVERSO SWITZER AIRSOFT

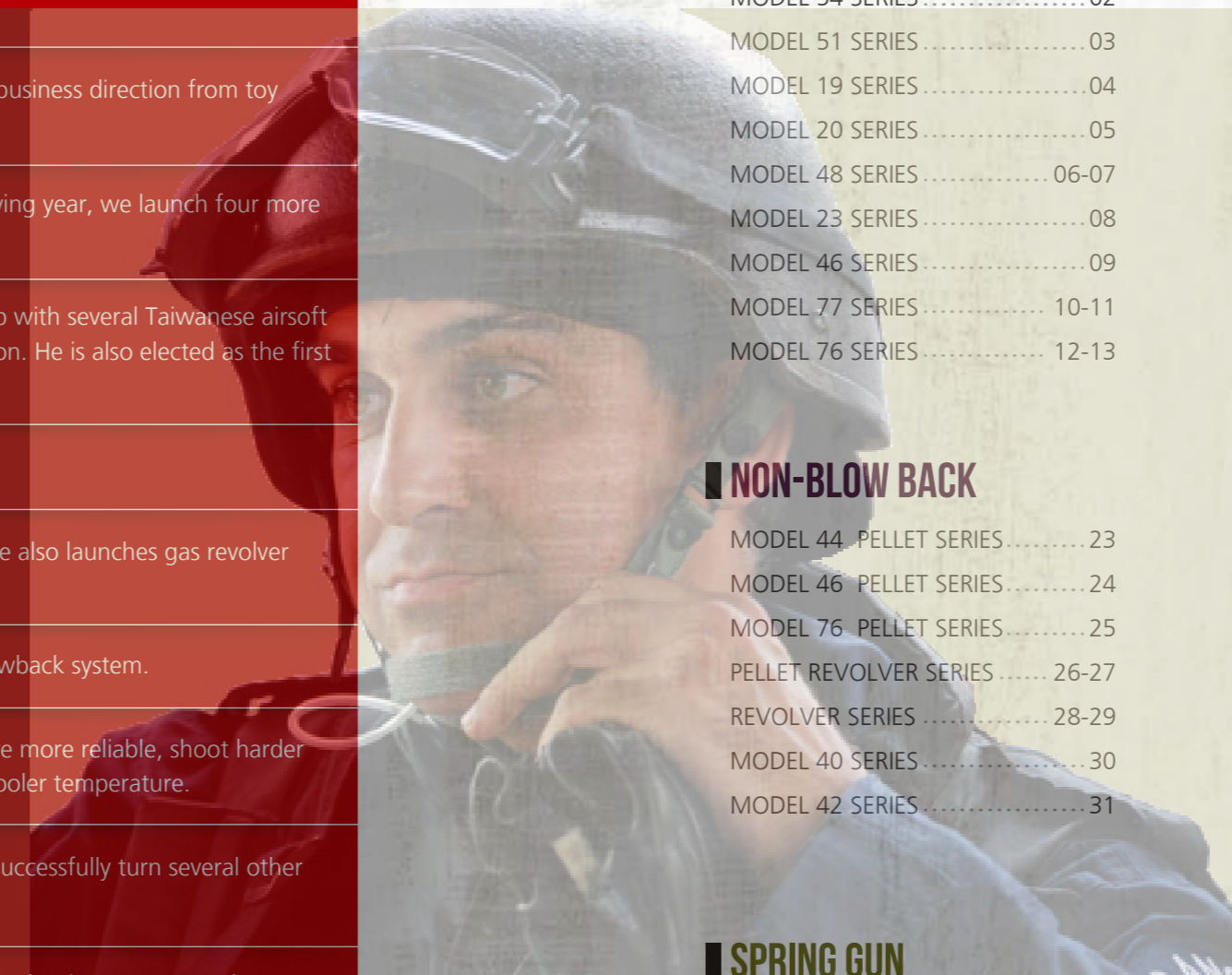

MODEL 54 SERIES

- High grade CO2 blowback
- 1:1 scale
- Semi auto / Full auto
- Operated by 12g CO2 cartridge
- Adjustable Hop up system
- Real gun disassembly process
- Real gun operation including ejection port and hold open



Integral muzzle break



Full auto option available



Double Action & Single Action

AAKCMF540AZB

AIRGUN

STEEL BB
4.5 mm (0.177")

FULL AUTO

CO₂

RECOIL	WEIGHT	LENGTH	ENERGY	VELOCITY	MATERIAL	BB CAPACITY	MAGAZINE
BLOWBACK	1100 g	269 mm	2.0 Joule Max	105 m/s Max	METAL SLIDE	15 rds.	AAKMM510AZQ

AAKCF540AZB

AIRSOFT

AIRSOFT
6 mm (0.2g)

FULL AUTO

CO₂

RECOIL	WEIGHT	LENGTH	ENERGY	VELOCITY	MATERIAL	BB CAPACITY	MAGAZINE
BLOWBACK	1094 g	269 mm	1.3 Joule Max	112 m/s Max	METAL SLIDE	21 rds.	AAKCM510AZQ



MODEL 51 SERIES

- High grade CO2 blowback
- 1:1 scale
- Operated by 12g CO2 cartridge
- Adjustable Hop up system
- Real gun disassembly process
- Real gun operation including ejection port and hold open



Semi Auto



Double Action & Single Action

AAKCB510AZB / AAKCB510BZB

AIRSOFT

AIRSOFT
6 mm (0.2g)

CO₂

RECOIL	WEIGHT	LENGTH	ENERGY	VELOCITY	MATERIAL	BB CAPACITY	MAGAZINE
BLOWBACK	1100 g	265 mm	1.6 Joule Max	126 m/s Max	METAL SLIDE	21 rds.	AAKCM510AZQ

AAKACZ510AZB

SPRING GUN

AIRSOFT
6 mm (0.2g)

WVWVWV
SPRING

RECOIL	WEIGHT	LENGTH	ENERGY	VELOCITY	MATERIAL	BB CAPACITY	MAGAZINE
SPRING COCKING	895 g	274 mm	0.5 Joule Max	73 m/s Max	HEAVY WEIGHT	26 rds.	AAKACS510AZN



AAKCB510BZB
Silver Version Available





AAKCMB191AZB

AIRGUN

STEEL BB 4.5
4.5 mm (0.177) CO₂

RECOIL	WEIGHT	LENGTH	ENERGY	VELOCITY	MATERIAL	BB CAPACITY	MAGAZINE
BLOWBACK	750 g	205 mm	1.7 Joule Max	100 m/s Max	METAL SLIDE	17 rds.	AAKMM190AZQ

AAKCCB191AZB

AIRSOFT

AIRSOFT 6
6 mm (0.2g) CO₂

RECOIL	WEIGHT	LENGTH	ENERGY	VELOCITY	MATERIAL	BB CAPACITY	MAGAZINE
BLOWBACK	745 g	197 mm	1.2 Joule Max	111 m/s Max	METAL SLIDE	15 rds.	AAKCCM190AZQ



Ported slide



Trigger Safety



Adjustable Hop up



Tactical Sight

MODEL 19 - 20 SERIES

- Premium blowback airgun
- Full function blowback
- 1:1 scale
- Weaver rail compatible with standard flashlight and laser
- Semi auto / full auto options on model 20
- Operated by 12g CO₂ cartridge
- Adjustable Hop up system



AAKCMF201AZB

AIRGUN

STEEL BB 4.5
4.5 mm (0.177) CO₂

FULL AUTO

CO₂

RECOIL	WEIGHT	LENGTH	ENERGY	VELOCITY	MATERIAL	BB CAPACITY	MAGAZINE
BLOWBACK	755 g	205 mm	1.5 Joule Max	92 m/s Max	METAL SLIDE	17 rds.	AAKMM190AZQ

AAKCCF201AZB

AIRSOFT

AIRSOFT 6
6 mm (0.2g) CO₂

FULL AUTO

CO₂

RECOIL	WEIGHT	LENGTH	ENERGY	VELOCITY	MATERIAL	BB CAPACITY	MAGAZINE
BLOWBACK	730 g	205 mm	1.4 Joule Max	118 m/s Max	METAL SLIDE	15 rds.	AAKCCM190AZQ

MODEL 48 SERIES

- Full function blowback
- 1:1 scale
- Operated by 12g CO2 cartridge
- Semi auto
- Adjustable Hop up system
- Real gun disassembly process
- Real gun operation including ejection port and hold open
- Interchangeable grips with three different sizes



▲ Interchangeable grips in different sizes



Scalloped Slide Serrations



Adjustable Hop up

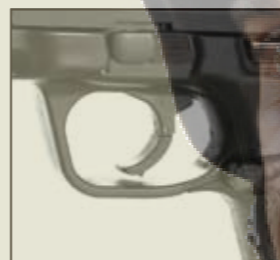

Single Action Only



Tactical Rail



Ported slide



Single Action Only



Hidden manual safety



Blowback



▲ Interchangeable grips in different sizes

AAKCMB480AZB

AIRGUN



RECOIL	WEIGHT	LENGTH	ENERGY	VELOCITY	MATERIAL	BB CAPACITY	MAGAZINE
BLOWBACK	724 g	194 mm	1.6 Joule Max	95 m/s Max	METAL SLIDE	15 rds.	AAKMM480AZQ

AAKCCB480AZB

AIRSOFT



RECOIL	WEIGHT	LENGTH	ENERGY	VELOCITY	MATERIAL	BB CAPACITY	MAGAZINE
BLOWBACK	710 g	194 mm	1.4 Joule Max	117 m/s Max	METAL SLIDE	15 rds.	AAKCCM480AZQ

AAKCMB483AZB

AIRGUN



RECOIL	WEIGHT	LENGTH	ENERGY	VELOCITY	MATERIAL	BB CAPACITY	MAGAZINE
BLOWBACK	760 g	214 mm	1.9 Joule Max	102 m/s Max	METAL SLIDE	15 rds.	AAKMM480AZQ

AAKCCB483AZB

AIRSOFT



RECOIL	WEIGHT	LENGTH	ENERGY	VELOCITY	MATERIAL	BB CAPACITY	MAGAZINE
BLOWBACK	758 g	214 mm	1.7 Joule Max	131 m/s Max	METAL SLIDE	15 rds.	AAKCCM480AZQ

MODEL 23 SERIES



Double Action & Single Action



Weaver rail

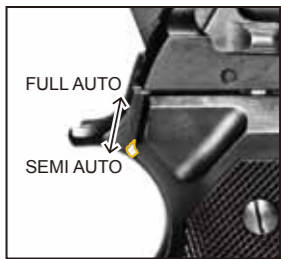

Semi auto / Full auto



Ambidextrous Safety & Decocker

- High grade CO2 blowback
- 1:1 scale
- Operated by 12g CO2 cartridge
- Adjustable Hop up system
- Semi auto / Full auto
- Real gun disassembly process
- Ambidextrous safety and decocker
- Weaver rail compatible with standard flashlight, laser or scopes.

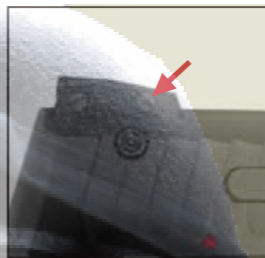

Adjustable sight



Single Action



Ambidextrous safety



Interchangeable grips

MODEL 46 SERIES

- 1:1 scale
- Operated by 12g CO2 cartridge
- Weaver rail compatible with standard flashlight or laser
- Functional trigger safety



AAKCCB460EVB
DUAL TONE



AAKCMF230AZB

AIRGUN

STEEL BB 4.5
4.5 mm (0.177")

FULL AUTO

CO₂

RECOIL	WEIGHT	LENGTH	ENERGY	VELOCITY	MATERIAL	BB CAPACITY	MAGAZINE
BLOWBACK	1080 g	216 mm	1.5 Joule Max	95 m/s Max	FULL METAL	18 rds.	AAKMM230AZQ

AAKCCF230AJB

AIRSOFT

AIRSOFT 6
6 mm (0.2g)

FULL AUTO

CO₂

RECOIL	WEIGHT	LENGTH	ENERGY	VELOCITY	MATERIAL	BB CAPACITY	MAGAZINE
BLOWBACK	1069 g	216 mm	1.5 Joule Max	125 m/s Max	FULL METAL	21 rds.	AAKCCM230AZQ

MODEL 77 SERIES

- Full function blowback
- 1:1 scale
- Operated by 12g CO2 cartridge
- Semi auto
- Adjustable Hop up system
- Real gun disassembly process
- Real gun operation including ejection port and hold open
- Strong blowback recoil



AAKCMB770AZB

AIRGUN

STEEL BB 4.5
4.5 mm (0.177")

CO₂

RECOIL	WEIGHT	LENGTH	ENERGY	VELOCITY	MATERIAL	BB CAPACITY	MAGAZINE
BLOWBACK	925 g	220 mm	1.6 Joule Max	97 m/s Max	FULL METAL	17 rds.	AAKMM770AZQ

AAKCCB770AZB

AIRSOFT

AIRSOFT 6
6 mm (0.2g)

CO₂

RECOIL	WEIGHT	LENGTH	ENERGY	VELOCITY	MATERIAL	BB CAPACITY	MAGAZINE
BLOWBACK	900 g	218 mm	1.4 Joule Max	118 m/s Max	FULL METAL	14 rds.	AAKCCM770AZQ

CUSTOMIZATION



Weathering Edition

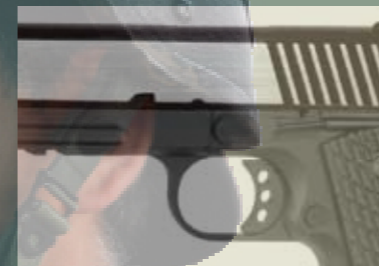

Slide With Hair Line Edition



Multi Color Grip



Blowback

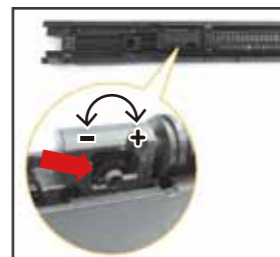

Adjustable Hop up



High Capacity Magazine Available

Extended Magazine see P49





MODEL 76 SERIES

- Full function blowback
- 1:1 scale
- Operated by 12g CO2 cartridge
- Semi auto
- Adjustable HOP UP system
- Real gun disassembly process
- Real Gun operation including ejection port and hold open
- Strong blowback recoil



Customization (weathering edition)



Grip Safety

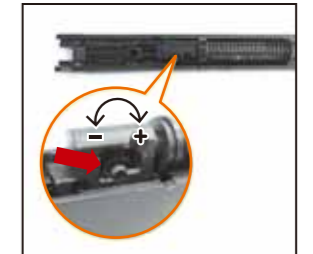

Adjustable Hop up

AAKCMB760AZB

AIRGUN

STEEL BB 4.5
4.5 mm (0.177")

CO₂

RECOIL	WEIGHT	LENGTH	ENERGY	VELOCITY	MATERIAL	BB CAPACITY	MAGAZINE
BLOWBACK	900 g	215 mm	1.7 Joule Max	100 m/s Max	FULL METAL	17 rds.	AAKMM760AZQ

AAKCCB760AZB

AIRSOFT

AIRSOFT 6
6 mm (0.2g)

CO₂

RECOIL	WEIGHT	LENGTH	ENERGY	VELOCITY	MATERIAL	BB CAPACITY	MAGAZINE
BLOWBACK	890 g	218 mm	1.4 Joule Max	118 m/s Max	FULL METAL	14 rds.	AAKCCM760AZQ





MODEL 15 SERIES

- High grade CO2 blowback
- Full function blowback
- 1:1 scale
- Operated by 12g CO2 cartridge
- Weaver rail compatible with standard flashlight and laser
- Semi auto / Full auto
- Adjustable Hop up system
- Real gun disassembly process
- Real gun operation including ejection port and hold open



Blowback



Double Action and Single Action



Semi Auto



Full Auto



MODEL 41 SERIES

- Realism toggle-lock recoil operation
- 1:1 SCALE
- Operated by 12g CO2 cartridge
- Real gun disassembly process
- Real gun operation including hold open



AAKCMB410AZB

AIRGUN

STEEL BB 4.5
4.5 mm (0.177")

CO₂

RECOIL	WEIGHT	LENGTH	ENERGY	VELOCITY	MATERIAL	BB CAPACITY	MAGAZINE
BLOWBACK	834 g	220 mm	1.6 Joule Max	95 m/s Max	FULL METAL	21 rds.	AAKMMM410AZQ

AAKCCB410AZB

AIRSOFT

AIRSOFT 6
6 mm (0.2g)

CO₂

RECOIL	WEIGHT	LENGTH	ENERGY	VELOCITY	MATERIAL	BB CAPACITY	MAGAZINE
BLOWBACK	830 g	220 mm	1.3 Joule Max	112 m/s Max	FULL METAL	15 rds.	AAKCCM410AZQ

AAKCMF150AZB

AIRGUN

STEEL BB 4.5
4.5 mm (0.177")

FULL AUTO

CO₂

RECOIL	WEIGHT	LENGTH	ENERGY	VELOCITY	MATERIAL	BB CAPACITY	MAGAZINE
BLOWBACK	1100 g	215 mm	1.7 Joule Max	99 m/s Max	FULL METAL	19 rds.	AAKMMM150AZQ

AAKCCF150AZB

AIRSOFT

AIRSOFT 6
6 mm (0.2g)

FULL AUTO

CO₂

RECOIL	WEIGHT	LENGTH	ENERGY	VELOCITY	MATERIAL	BB CAPACITY	MAGAZINE
BLOWBACK	1100 g	215 mm	1.6 Joule Max	126 m/s Max	FULL METAL	27 rds.	AAKCCM150AZQ



4" BARREL



Realism Toggle-lock Recoil



1:1 SCALE



Rear Sight Cover

MODEL 07 SERIES

- Full function CO2 blowback
- 1:1 scale
- Semi auto / Full auto
- Adjustable Hop up system
- Real gun operation including ejection port and hold open



Blowback

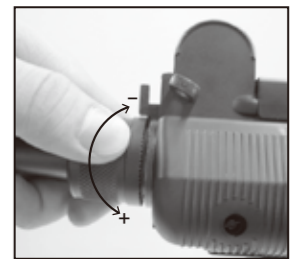

Adjustable Hop up

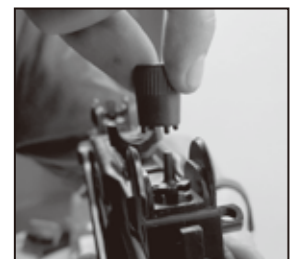

Adjustable Front Sight



Adjustable Rear Sight

MODEL 18 SERIES

- Full function blowback
- 1:1 scale
- Operated by 12g CO2 cartridge.
- Semi auto / Full auto
- Adjustable Hop up system
- Real gun disassembly process
- Real gun operation including ejection port



Rear Sight Adjustment



Semi / Full Auto Switch

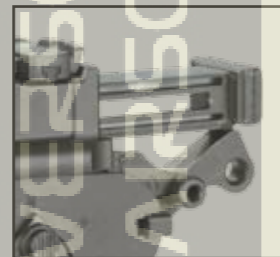

Blowback

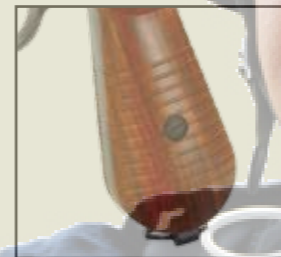

Wooden Pattern Grip



AAKCMF180AZB

AIRGUN

STEEL BB 4.5
4.5 mm (0.177")

FULL AUTO

CO₂

RECOIL	WEIGHT	LENGTH	ENERGY	VELOCITY	MATERIAL	BB CAPACITY	MAGAZINE
BLOWBACK	1410 g	300 mm	2.4 Joule Max	118 m/s Max	FULL METAL	19 rds.	AAKMMM180AZQ

AAKCCF180AZB

AIRSOFT

AIRSOFT 6
6 mm (0.2g)

FULL AUTO

CO₂

RECOIL	WEIGHT	LENGTH	ENERGY	VELOCITY	MATERIAL	BB CAPACITY	MAGAZINE
BLOWBACK	1400 g	300 mm	1.7 Joule Max	133 m/s Max	FULL METAL	22 rds.	AAKCCM180AZQ

AAKCMF070AZB

AIRGUN

STEEL BB 4.5
4.5 mm (0.177")

FULL AUTO

CO₂

RECOIL	WEIGHT	LENGTH	ENERGY	VELOCITY	MATERIAL	BB CAPACITY	MAGAZINE
BLOWBACK	2000 g	596 mm	1.8 Joule Max	101 m/s Max	HALF METAL	25 rds.	AAKMM070AZQ

AAKCCF070AZB

AIRSOFT

AIRSOFT 6
6 mm (0.2g)

FULL AUTO

CO₂

RECOIL	WEIGHT	LENGTH	ENERGY	VELOCITY	MATERIAL	BB CAPACITY	MAGAZINE
BLOWBACK	2000 g	596 mm	1.8 Joule Max	135 m/s Max	HALF METAL	39 rds.	AAKCCM070AZQ

MODEL 88 - 89 SERIES

- IPSC Pistol
- High grade CO2 blowback
- Full function blowback
- 1:1 Scale
- Operated by 12g CO2 cartridge
- Mount rail compatible with scopes and red dots
- Semi Auto
- Adjustable HOP UP system
- Real gun disassembly process
- Real Gun operation including ejection port and hold open

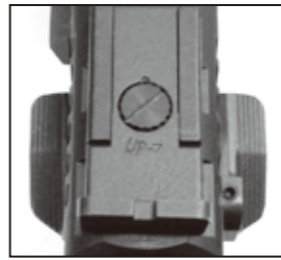

Rear Sight Adjustment



Ambidextrous Manual Safety

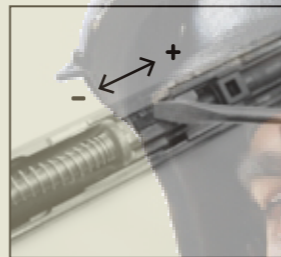

Adjustable Hop up



AAKCMB880AZB

AIRGUN

STEEL BB 4.5
4.5 mm (0.177")

CO₂

RECOIL	WEIGHT	LENGTH	ENERGY	VELOCITY	MATERIAL	BB CAPACITY	MAGAZINE
BLOWBACK	1240 g	215 mm	2.3 Joule Max	115 m/s Max	FULL METAL	16 rds.	AAKMM780AZQ

AAKCCB880AZB

AIRSOFT

AIRSOFT 6
6 mm (0.2g)

CO₂

RECOIL	WEIGHT	LENGTH	ENERGY	VELOCITY	MATERIAL	BB CAPACITY	MAGAZINE
BLOWBACK	1150 g	215 mm	1.4 Joule Max	120 m/s Max	FULL METAL	16 rds.	AAKCCM780AZQ



Rail Can Add The Laser Scope



Slide Loading Bar



Muzzle brake

AAKCM890AZB

AIRGUN

STEEL BB 4.5
4.5 mm (0.177")

CO₂

RECOIL	WEIGHT	LENGTH	ENERGY	VELOCITY	MATERIAL	BB CAPACITY	MAGAZINE
BLOWBACK	1250 g	279 mm	1.9 Joule Max	103 m/s Max	FULL METAL	17 rds.	AAKMM780AZQ

AAKCC890AZB

AIRSOFT

AIRSOFT 6
6 mm (0.2g)

CO₂

RECOIL	WEIGHT	LENGTH	ENERGY	VELOCITY	MATERIAL	BB CAPACITY	MAGAZINE
BLOWBACK	1250 g	279 mm	1.4 Joule Max	119 m/s Max	FULL METAL	16 rds.	AAKCCM780AZQ



Rear Sight Cover



Blowback



Anti Skid Grip

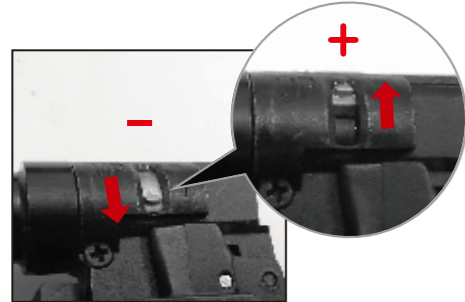

Adjustable Hop up

MODEL 44 SERIES

- Compact pistol
- Full function blowback
- Classic collector's replica
- High grade CO2 blowback
- Operated by 12g CO2 cartridge
- Semi auto
- Adjustable Hop-up system
- Real gun operation including hold open
- Real gun disassembly process



Blowback

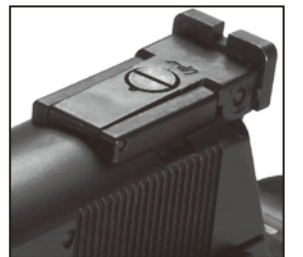

Adjustable Rear Sight

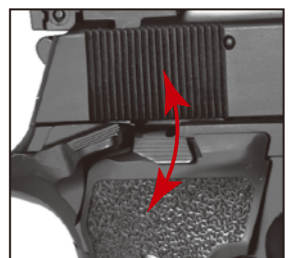

Ambidextrous Safety

MODEL 74 SERIES

- High grade CO2 blowback
- CO2 blowback
- 1:1 scale
- Operated by 12g CO2 cartridge
- Adjustable Hop up system
- Real gun disassembly process
- Real gun operation including ejection port and hold open



AAKCMB440AZB

AIRGUN



RECOIL	WEIGHT	LENGTH	ENERGY	VELOCITY	MATERIAL	BB CAPACITY	MAGAZINE
BLOWBACK	737 g	160 mm	1.5 Joule Max	92 m/s Max	FULL METAL	15 rds.	AAKMM440AZQ

AAKCCB440AZB

AIRSOFT



RECOIL	WEIGHT	LENGTH	ENERGY	VELOCITY	MATERIAL	BB CAPACITY	MAGAZINE
BLOWBACK	737 g	160 mm	1.3 Joule Max	113 m/s Max	FULL METAL	15 rds.	AAKCCM440AZQ

AAKCB740AZB

AIRGUN



RECOIL	WEIGHT	LENGTH	ENERGY	VELOCITY	MATERIAL	BB CAPACITY	MAGAZINE
BLOWBACK	1275 g	225 mm	2.0 Joule Max	108 m/s Max	FULL METAL	18 rds.	AAKCBM740AZQ

AAKCCB740AZB

AIRSOFT



RECOIL	WEIGHT	LENGTH	ENERGY	VELOCITY	MATERIAL	BB CAPACITY	MAGAZINE
BLOWBACK	1220 g	225 mm	1.8 Joule Max	135 m/s Max	FULL METAL	24 rds.	AAKCCM740AZQ



Blowback

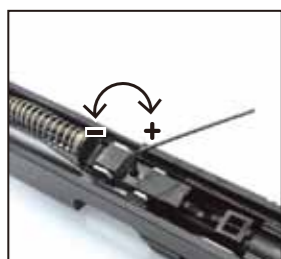

Adjustable Hop up

MODEL 12 SERIES

- Full function blowback
- 1:1 scale
- Operated by 12g CO2 cartridge.
- Semi auto
- Adjustable Hop up system
- Real gun disassembly process
- Real gun operation including ejection port and hold open

MODEL 44 PELLET SERIES

- Compact pistol
- Classic collector's replica
- Operated by 12g CO2 cartridge
- Novel pellet rotary clip design
- Equipped with high precision rifled barrel
- Spare magazine part # AAKCPS440
- Spare rotary clip part # AAKCPW440



AIRGUN PELLETS



AAKCPD441AZB

AIRGUN

PELLETS AIR GUN
4.5 mm (0.177")

CO₂

RECOIL	WEIGHT	LENGTH	ENERGY	VELOCITY	MATERIAL	BB CAPACITY	MAGAZINE
NON-BLOWBACK	754 g	162 mm	2.6 Joule Max	105 m/s Max	FULL METAL	6X2 Pellet	AAKCPS440

AAKCMB120AZB

AIRGUN

STEEL BB
4.5 mm (0.177") 4.5

CO₂

RECOIL	WEIGHT	LENGTH	ENERGY	VELOCITY	MATERIAL	BB CAPACITY	MAGAZINE
BLOWBACK	875 g	200 mm	1.7 Joule Max	97 m/s Max	METAL SLIDE	19 rds.	AAKMM120AZQ

AAKCCB120AZB

AIRSOFT

AIRSOFT
6 mm (0.2g) 6

CO₂

RECOIL	WEIGHT	LENGTH	ENERGY	VELOCITY	MATERIAL	BB CAPACITY	MAGAZINE
BLOWBACK	900 g	200 mm	1.4 Joule Max	116 m/s Max	METAL SLIDE	22 rds.	AAKCCM120AZQ



6X2 Rotary Clip



Rear Sight Cover



Anti Skid Grip



MODEL 46 PELLET SERIES

- Operated by 12g CO2 cartridge
- Semi auto only
- Novel pellet rotary clip design
- Tactical design with railed full metal slide
- Equipped with high precision rifled barrel
- Spare magazine part # AAKCPS460
- Spare rotary clip part # AAKCPW460



8X2 Rotary Clip



Fiber Optic Sights

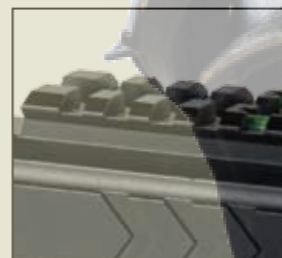

Tactical Railed Slide



Rubberized Grip



AIRGUN PELLETS



AAKCPD463AZB AIRGUN PELLETS AIR GUN 4.5 mm (0.177") CO₂

RECOIL	WEIGHT	LENGTH	ENERGY	VELOCITY	MATERIAL	BB CAPACITY	MAGAZINE
NON-BLOWBACK	799 g	182 mm	2.9 Joule Max	110 m/s Max	METAL SLIDE	8X2 Pellet	AAKCPW460



MODEL 76 PELLET SERIES

- 1:1 SCALE
- Operated by 12g CO2
- SEMI AUTO
- Novel pellet rotary clip design
- Equipped with high precision rifled barrel
- Spare rotary clip part # AAKCPW760AZN

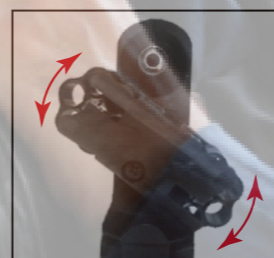

6X2 Rotary Clip



Anti Skid Grip



AIRGUN PELLETS



AAKCPD761AZB AIRGUN PELLETS AIR GUN 4.5 mm (0.177") CO₂

RECOIL	WEIGHT	LENGTH	ENERGY	VELOCITY	MATERIAL	BB CAPACITY	MAGAZINE
NON-BLOWBACK	990 g	220 mm	2.8 Joule Max	105 m/s Max	METAL SLIDE	6X2 Pellet	AAKCPW760AZQ

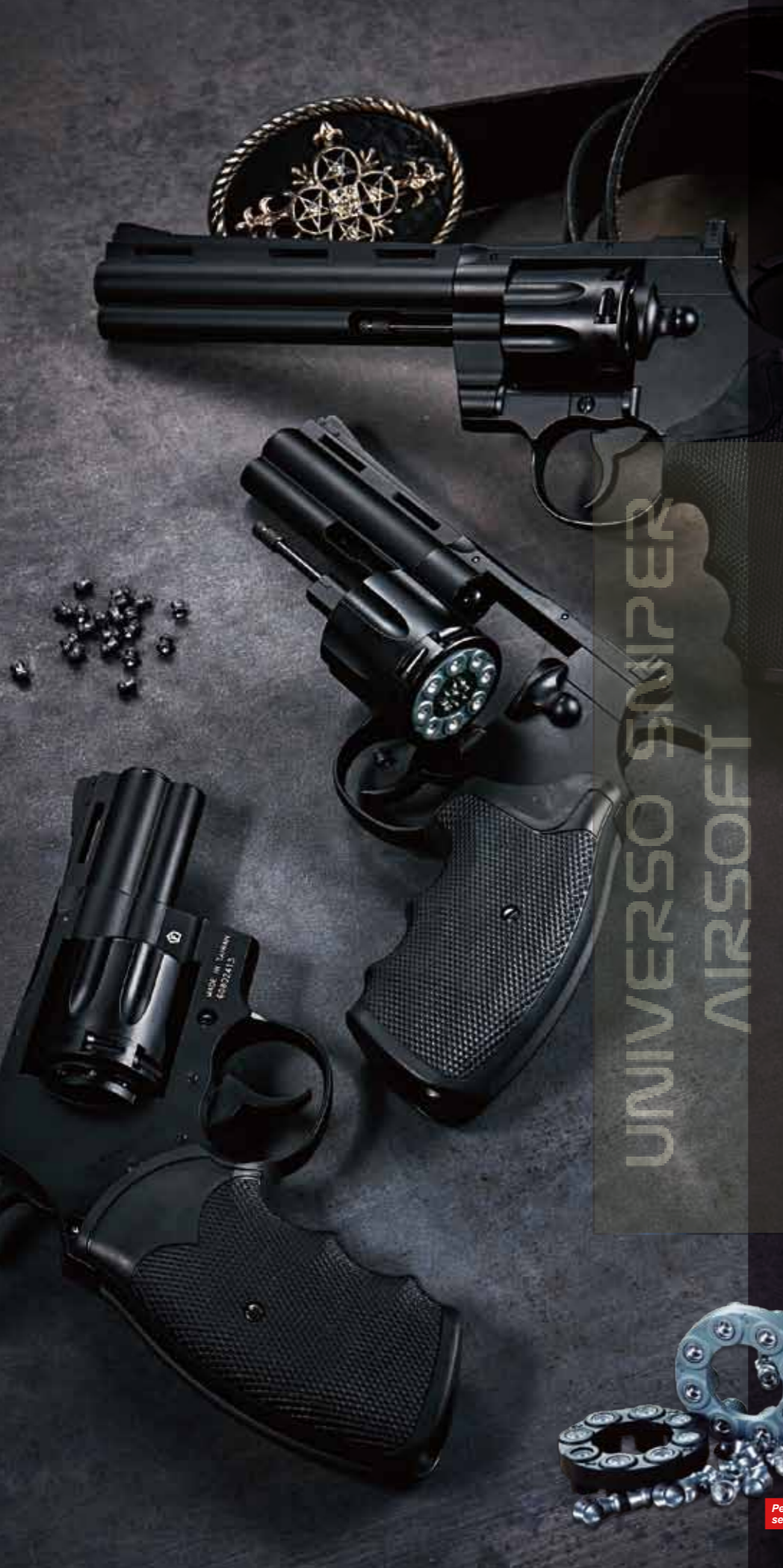

PELLET REVOLVER SERIES

- Classic revolver
- 1:1 scale
- Rotary pellet clip



Double Action & Single Action Trigger



Anti Skid Grip



Vertical Adjustment



Horizontal Adjustment



AAKCPD681AZB
BARREL LENGTH 6 INCH



AAKCPD671AZB
BARREL LENGTH 4 INCH



AAKCPD661AZB
BARREL LENGTH 2.5 INCH



AIRGUN PELLETS

AAKCPD661AZB	AIRGUN	PELLETS AIR GUN 4.5 mm (0.177")	CO ₂				
RECOIL	WEIGHT	LENGTH	ENERGY	VELOCITY	MATERIAL	BB CAPACITY	MAGAZINE
NON-BLOWBACK	870 g	195 mm	2.5 Joule Max	100 m/s Max	FULL METAL	8 Pellet	AAKCPW680AZN

AAKCPD671AZB	AIRGUN	PELLETS AIR GUN 4.5 mm (0.177")	CO ₂				
RECOIL	WEIGHT	LENGTH	ENERGY	VELOCITY	MATERIAL	BB CAPACITY	MAGAZINE
NON-BLOWBACK	955 g	230 mm	2.8 Joule Max	108 m/s Max	FULL METAL	8 Pellet	AAKCPW680AZN

AAKCPD681AZB	AIRGUN	PELLETS AIR GUN 4.5 mm (0.177")	CO ₂				
RECOIL	WEIGHT	LENGTH	ENERGY	VELOCITY	MATERIAL	BB CAPACITY	MAGAZINE
NON-BLOWBACK	1085 g	285 mm	3.0 Joule Max	110 m/s Max	FULL METAL	8 Pellet	AAKCPW680AZN



Pellet clip Available see P49

REVOLVER SERIES

- Classic revolver
- Double action & singl action trigger
- Full metal
- Shell loaded revolver



◀ BARREL LENGTH
4 INCH



AAKCMD671AZB

AIRGUN

STEEL BB 4.5
4.5 mm (0.177")

CO₂

RECOIL	WEIGHT	LENGTH	ENERGY	VELOCITY	MATERIAL	BB CAPACITY	MAGAZINE
NON-BLOWBACK	950 g	235 mm	2.0 Joule Max	109 m/s Max	METAL SLIDE	6 rds.	AAKCMW680AZL

AAKCCD671AZB

AIRSOFT

AIRSOFT 6
6 mm (0.2g)

CO₂

RECOIL	WEIGHT	LENGTH	ENERGY	VELOCITY	MATERIAL	BB CAPACITY	MAGAZINE
NON-BLOWBACK	950 g	235 mm	1.9 Joule Max	138 m/s Max	METAL SLIDE	6 rds.	AAKCCW680AZL



◀ BARREL LENGTH
6 INCH



Chrome Plating Finish

AAKCMD682EZB

AIRGUN

STEEL BB 4.5
4.5 mm (0.177")

CO₂

RECOIL	WEIGHT	LENGTH	ENERGY	VELOCITY	MATERIAL	BB CAPACITY	MAGAZINE
NON-BLOWBACK	1100 g	285 mm	2.7 Joule Max	125 m/s Max	FULL METAL	6 rds.	AAKCMW680AZL



Vertical Adjustment

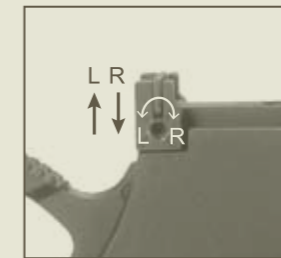

Horizontal Adjustment



Manual Safety



Speedloader

Speedloader see P49



◀ BARREL LENGTH
6 INCH



AAKCMD681AZB

AIRGUN

STEEL BB 4.5
4.5 mm (0.177")

CO₂

RECOIL	WEIGHT	LENGTH	ENERGY	VELOCITY	MATERIAL	BB CAPACITY	MAGAZINE
NON-BLOWBACK	1100 g	285 mm	2.7 Joule Max	125 m/s Max	FULL METAL	6 rds.	AAKCMW680AZL

AAKCCD681AZB

AIRSOFT

AIRSOFT 6
6 mm (0.2g)

CO₂

RECOIL	WEIGHT	LENGTH	ENERGY	VELOCITY	MATERIAL	BB CAPACITY	MAGAZINE
NON-BLOWBACK	1100 g	285 mm	2.7 Joule Max	165 m/s Max	FULL METAL	6 rds.	AAKCCW680AZL



◀ BARREL LENGTH
2.5 INCH



AAKCMD661EZB
Chrome Plating Finish

AAKCMD661AZB / AAKCMD661EZB

AIRGUN

STEEL BB 4.5
4.5 mm (0.177")

CO₂

RECOIL	WEIGHT	LENGTH	ENERGY	VELOCITY	MATERIAL	BB CAPACITY	MAGAZINE
NON-BLOWBACK	900 g	200 mm	1.3 Joule Max	86 m/s Max	METAL SLIDE	6 rds.	AAKCMW680AZL

AAKCCD661AZB

AIRSOFT

AIRSOFT 6
6 mm (0.2g)

CO₂

RECOIL	WEIGHT	LENGTH	ENERGY	VELOCITY	MATERIAL	BB CAPACITY	MAGAZINE
NON-BLOWBACK	900 g	200 mm	1.6 Joule Max	125 m/s Max	METAL SLIDE	6 rds.	AAKCCW680AZL

MODEL 40 - 42 SERIES

- 1:1 scale
- Operated by 12g CO2 cartridge
- Semi auto
- Interchangeable parts between non-blow back 40's series and 42's series. Works great for customization.
- Efficient CO2 shooting system with more than 200 BB shots per CO2 cartridge
- Full Metal grip on 42 series.



Tactical Rail



AAKCMD401AZB

AIRGUN

STEEL BB 4.5

CO₂

RECOIL	WEIGHT	LENGTH	ENERGY	VELOCITY	MATERIAL	BB CAPACITY	MAGAZINE
NON-BLOWBACK	840 g	220 mm	2.5 Joule Max	120 m/s Max	METAL SLIDE	21 rds.	AAKCMS400AZQ

AAKCCD401AZB

AIRSOFT

AIRSOFT 6

CO₂

RECOIL	WEIGHT	LENGTH	ENERGY	VELOCITY	MATERIAL	BB CAPACITY	MAGAZINE
NON-BLOWBACK	840 g	220 mm	2.5 Joule Max	157 m/s Max	METAL SLIDE	15 rds.	AAKCCS400AZQ



Tactical Rail



AAKCMD421AZB

AIRGUN

STEEL BB 4.5

CO₂

RECOIL	WEIGHT	LENGTH	ENERGY	VELOCITY	MATERIAL	BB CAPACITY	MAGAZINE
NON-BLOWBACK	1073 g	223 mm	2.5 Joule Max	120 m/s Max	METAL SLIDE	20 rds.	AAKCMS420AZQ

AAKCCD421AZB

AIRSOFT

AIRSOFT 6

CO₂

RECOIL	WEIGHT	LENGTH	ENERGY	VELOCITY	MATERIAL	BB CAPACITY	MAGAZINE
NON-BLOWBACK	1050 g	220 mm	2.3 Joule Max	152 m/s Max	METAL SLIDE	14 rds.	AAKCCS420AZQ

MODEL 43 SERIES

- 1:1 scale
- Operated by 12g CO2 cartridge
- Efficient CO2 shooting system with more than 200 BB shots per CO2 cartridge
- Semi auto
- Metal slide and hammer case for realistic weight



MODEL 44 SERIES

- 1:1 scale
- Operated by 12g CO2 cartridge
- Semi auto only
- Compact of pistol
- Super stable and long life



Anti Skid Grip

AAKCMD431AZB

AIRGUN



RECOIL	WEIGHT	LENGTH	ENERGY	VELOCITY	MATERIAL	BB CAPACITY	MAGAZINE
NON-BLOWBACK	800 g	205 mm	2.5 Joule Max	120 m/s Max	METAL SLIDE	21 rds.	AAKCMS430AZQ

AAKCCD431AZB

AIRSOFT



RECOIL	WEIGHT	LENGTH	ENERGY	VELOCITY	MATERIAL	BB CAPACITY	MAGAZINE
NON-BLOWBACK	800 g	205 mm	1.8 Joule Max	134 m/s Max	METAL SLIDE	15 rds.	AAKCCS430AZQ



AAKCMD440AZB

AIRGUN



RECOIL	WEIGHT	LENGTH	ENERGY	VELOCITY	MATERIAL	BB CAPACITY	MAGAZINE
NON-BLOWBACK	392 g	161 mm	2.7 Joule Max	125 m/s Max	PLASTIC	18 rds.	AAKCMS440AZQ

AAKCMD441AZB

AIRGUN



RECOIL	WEIGHT	LENGTH	ENERGY	VELOCITY	MATERIAL	BB CAPACITY	MAGAZINE
NON-BLOWBACK	800 g	160 mm	2.5 Joule Max	120 m/s Max	FULL METAL	18 rds.	AAKCMS440AZQ

AAKCCD441AZB

AIRSOFT



RECOIL	WEIGHT	LENGTH	ENERGY	VELOCITY	MATERIAL	BB CAPACITY	MAGAZINE
NON-BLOWBACK	775 g	160 mm	1.6 Joule Max	127 m/s Max	FULL METAL	13 rds.	AAKCCS440AZQ



Fixed Aperture Sight



High Capacity Magazine



Metal Telescopic Stock



Post Front Sight

UNIVERSO SNIPER AIRSOFT

MODEL 45 SERIES

- 1:1 scale
- Operated by 12g CO2 cartridge
- Semi auto only
- Compact of pistol
- Super stable and long life

AAKCMD550AZB

AIRGUN

STEEL BB 4.5
4.5 mm (0.177")

CO₂

RECOIL	WEIGHT	LENGTH	ENERGY	VELOCITY	MATERIAL	BB CAPACITY	MAGAZINE
NON-BLOWBACK	531 g	255 mm	2.5 Joule Max	120 m/s Max	PLASTIC WITH METAL STOCK	39 rds.	AAKCMS550AZQ

AAKCCD550AZB

AIRSOFT

AIRSOFT 6
6 mm (0.2g)

CO₂

RECOIL	WEIGHT	LENGTH	ENERGY	VELOCITY	MATERIAL	BB CAPACITY	MAGAZINE
NON-BLOWBACK	531 g	255 mm	2.3 Joule Max	152 m/s Max	PLASTIC WITH METAL STOCK	26 rds.	AAKCCS550AZQ

MODEL 55 SERIES

- 1:1 scale
- Operated by 12g CO2 cartridge
- Super stable and long life.
- Telescopic stock
- High capacity magazine
- Semi auto only



AAKCMD451AZB

AIRGUN

STEEL BB 4.5
4.5 mm (0.177")

CO₂

RECOIL	WEIGHT	LENGTH	ENERGY	VELOCITY	MATERIAL	BB CAPACITY	MAGAZINE
NON-BLOWBACK	700 g	194 mm	2.5 Joule Max	120 m/s Max	FULL METAL	19 rds.	AAKCMS450AZQ

AAKCCD451AZC

AIRSOFT

AIRSOFT 6
6 mm (0.2g)

CO₂

RECOIL	WEIGHT	LENGTH	ENERGY	VELOCITY	MATERIAL	BB CAPACITY	MAGAZINE
NON-BLOWBACK	700 g	194 mm	2.2 Joule Max	150 m/s Max	FULL METAL	15 rds.	AAKCCS450AZQ



MODEL 46 SERIES

- 1:1 scale
- Operated by 12g CO2 cartridge
- Efficient CO2 shooting system with more than 200 BBS shots per CO2 cartridge
- Weaver rail compatible with standard flashlight or laser
- Rubber grip
- Series of products with several versions of different materials and power sources, see chart below for more detail





Rubber Grip





UNIVERSAL SNIPER AIRSOFT

AAKCMD460AZB AIRGUN  



RECOIL	WEIGHT	LENGTH	ENERGY	VELOCITY	MATERIAL	BB CAPACITY	MAGAZINE
NON-BLOWBACK	565 g	180 mm	2.5 Joule Max	120 m/s Max	PLASTIC SLIDE	21 rds.	AAKCMS460AZQ

AAKCMD461AZB AIRGUN  



RECOIL	WEIGHT	LENGTH	ENERGY	VELOCITY	MATERIAL	BB CAPACITY	MAGAZINE
NON-BLOWBACK	725 g	181 mm	2.5 Joule Max	120 m/s Max	METAL SLIDE	21 rds.	AAKCMS460AZQ

AAKCCD460AZB AIRSOFT  



RECOIL	WEIGHT	LENGTH	ENERGY	VELOCITY	MATERIAL	BB CAPACITY	MAGAZINE
NON-BLOWBACK	520 g	180 mm	1.8 Joule Max	134 m/s Max	PLASTIC SLIDE	15 rds.	AAKCCS460AZQ

AAKCCD461AZB AIRSOFT  



RECOIL	WEIGHT	LENGTH	ENERGY	VELOCITY	MATERIAL	BB CAPACITY	MAGAZINE
NON-BLOWBACK	710 g	181 mm	1.8 Joule Max	134 m/s Max	METAL SLIDE	15 rds.	AAKCCS460AZQ

AAKACZ460AZA SPRING GUN  



RECOIL	WEIGHT	LENGTH	ENERGY	VELOCITY	MATERIAL	BB CAPACITY	MAGAZINE
SPRING COCKING	580 g	180 mm	0.6 Joule Max	78 m/s Max	FULL PLASTIC	25 rds.	AAKACS460AZN

AAKCMD470AZB AIRGUN  

RECOIL	WEIGHT	LENGTH	ENERGY	VELOCITY	MATERIAL	BB CAPACITY	MAGAZINE
NON-BLOWBACK	590 g	190 mm	2.5 Joule Max	120 m/s Max	PLASTIC SLIDE	21 rds.	AAKCMS470AZQ

AAKCMD471AZB AIRGUN  



RECOIL	WEIGHT	LENGTH	ENERGY	VELOCITY	MATERIAL	BB CAPACITY	MAGAZINE
NON-BLOWBACK	760 g	190 mm	2.5 Joule Max	120 m/s Max	METAL SLIDE	21 rds.	AAKCMS470AZQ

AAKCCD470AZB AIRSOFT  

RECOIL	WEIGHT	LENGTH	ENERGY	VELOCITY	MATERIAL	BB CAPACITY	MAGAZINE
NON-BLOWBACK	510 g	185 mm	1.9 Joule Max	139 m/s Max	PLASTIC SLIDE	14 rds.	AAKCCS470AZQ

AAKCCD471AZB AIRSOFT  

RECOIL	WEIGHT	LENGTH	ENERGY	VELOCITY	MATERIAL	BB CAPACITY	MAGAZINE
NON-BLOWBACK	685 g	185 mm	1.9 Joule Max	139 m/s Max	METAL SLIDE	14 rds.	AAKCCS470AZQ

AAKACZ470AZA SPRING GUN  

RECOIL	WEIGHT	LENGTH	ENERGY	VELOCITY	MATERIAL	BB CAPACITY	MAGAZINE
SPRING COCKING	600 g	185 mm	0.6 Joule Max	75 m/s Max	FULL PLASTIC	24 rds.	AAKACS470AZN

MODEL 47 SERIES

- 1:1 scale
- Operated by 12g CO2 cartridge
- Efficient CO2 shooting system with more than 250 BBS shots per CO2 cartridge
- Weaver rail compatible with standard flashlight or laser
- Series of products with several versions of different materials and power sources, see chart below for more detail





UNIVERSO SNIPER AIRSOFT

MODEL 48 SERIES

- 1:1 scale
- Operated by 12g CO2 cartridge
- Efficient CO2 shooting system with more than 200 BBS shots per CO2 cartridge
- Weaver rail compatible with standard flashlight or laser
- Series of products with several versions of different materials and power sources, see chart below for more detail

AAKCMD480AZB

AIRGUN

STEEL BB 4.5
4.5 mm (0.177")

CO₂

RECOIL	WEIGHT	LENGTH	ENERGY	VELOCITY	MATERIAL	BB CAPACITY	MAGAZINE
NON-BLOWBACK	515 g	193 mm	2.5 Joule Max	120 m/s Max	PLASTIC SLIDE	19 rds.	AAKCMS480AZQ

AAKCMD481AZB

AIRGUN

STEEL BB 4.5
4.5 mm (0.177")

CO₂

RECOIL	WEIGHT	LENGTH	ENERGY	VELOCITY	MATERIAL	BB CAPACITY	MAGAZINE
NON-BLOWBACK	710 g	193 mm	2.5 Joule Max	120 m/s Max	METAL SLIDE	19 rds.	AAKCMS480AZQ

AAKCCD480AZB

AIRSOFT

AIRSOFT 6
6 mm (0.2g)

CO₂

RECOIL	WEIGHT	LENGTH	ENERGY	VELOCITY	MATERIAL	BB CAPACITY	MAGAZINE
NON-BLOWBACK	480 g	190 mm	1.9 Joule Max	139 m/s Max	PLASTIC SLIDE	15 rds.	AAKCCS480AZQ

AAKCCD481AZB

AIRSOFT

AIRSOFT 6
6 mm (0.2g)

CO₂

RECOIL	WEIGHT	LENGTH	ENERGY	VELOCITY	MATERIAL	BB CAPACITY	MAGAZINE
NON-BLOWBACK	700 g	190 mm	1.9 Joule Max	139 m/s Max	METAL SLIDE	15 rds.	AAKCCS480AZQ

AAKACZ480AZA

SPRING GUN

AIRSOFT 6
6 mm (0.2g)

SPRING

RECOIL	WEIGHT	LENGTH	ENERGY	VELOCITY	MATERIAL	BB CAPACITY	MAGAZINE
SPRING COCKING	520 g	190 mm	0.6 Joule Max	78 m/s Max	PLASTIC	24 rds.	AAKACS480AZN



SPRING AIRSOFT SERIES

- Easy operation with durable long life
- Great starter gun for beginners to the world of airsoft



AAKACZ142AZA

SPRING GUN



SPIN	WEIGHT	LENGTH	ENERGY	VELOCITY	MATERIAL	BB CAPACITY	MAGAZINE
NON HOP-UP	350 g	217 mm	0.6 Joule Max	78 m/s Max	FULL PLASTIC	12 rds.	AAKACS140AZN

AAKACZ142BZA

SPRING GUN



SPIN	WEIGHT	LENGTH	ENERGY	VELOCITY	MATERIAL	BB CAPACITY	MAGAZINE
NON HOP-UP	355 g	217 mm	0.6 Joule Max	78 m/s Max	FULL PLASTIC	12 rds.	AAKACS140BZN



AAKACZ030AZA

SPIN / HOP-UP

SPRING GUN



AAKACZ032AZA

SPIN / NON HOP-UP

WEIGHT	LENGTH	ENERGY	VELOCITY	MATERIAL	BB CAPACITY	MAGAZINE
400 g	200 mm	0.6 Joule Max	78 m/s Max	FULL PLASTIC	12 rds.	AAKACS030AZN

AAKACZ030BZA

SPIN / HOP-UP

SPRING GUN



AAKACZ032BZA

SPIN / NON HOP-UP

WEIGHT	LENGTH	ENERGY	VELOCITY	MATERIAL	BB CAPACITY	MAGAZINE
400 g	200 mm	0.5 Joule Max	75 m/s Max	FULL PLASTIC	12 rds.	AAKACS030BZN

AAKACZ142BZA
Silver Version Available

AAKACZ030BZA - AAKACZ032BZA
Silver Version Available



AAKACZ112BZA
Silver Version Available

AAKACZ112AZA

SPRING GUN



SPIN	WEIGHT	LENGTH	ENERGY	VELOCITY	MATERIAL	BB CAPACITY	MAGAZINE
NON HOP-UP	360 g	215 mm	0.6 Joule Max	78 m/s Max	FULL PLASTIC	12 rds.	AAKACS110AZN

AAKACZ112BZA

SPRING GUN



SPIN	WEIGHT	LENGTH	ENERGY	VELOCITY	MATERIAL	BB CAPACITY	MAGAZINE
NON HOP-UP	360 g	200 mm	0.6 Joule Max	78 m/s Max	FULL PLASTIC	12 rds.	AAKACS110AZN



AAKACZ130BZA - AAKACZ132BZA
Silver Version Available

AAKACZ130AZA

SPRING GUN



SPIN	WEIGHT	LENGTH	ENERGY	VELOCITY	MATERIAL	BB CAPACITY	MAGAZINE
HOP-UP	355 g	215 mm	0.6 Joule Max	78 m/s Max	FULL PLASTIC	12 rds.	AAKACS130AZN

AAKACZ130BZA

SPRING GUN



SPIN	WEIGHT	LENGTH	ENERGY	VELOCITY	MATERIAL	BB CAPACITY	MAGAZINE
HOP-UP	355 g	215 mm	0.6 Joule Max	78 m/s Max	FULL PLASTIC	12 rds.	AAKACS130BZN

AAKACZ132AZA

SPRING GUN



SPIN	WEIGHT	LENGTH	ENERGY	VELOCITY	MATERIAL	BB CAPACITY	MAGAZINE
NON-HOP UP	400 g	215 mm	0.6 Joule Max	78 m/s Max	FULL PLASTIC	12 rds.	AAKACS130AZN

AAKACZ132BZA

SPRING GUN



SPIN	WEIGHT	LENGTH	ENERGY	VELOCITY	MATERIAL	BB CAPACITY	MAGAZINE
NON-HOP UP	400 g	215 mm	0.6 Joule Max	78 m/s Max	FULL PLASTIC	12 rds.	AAKACS130BZN

SPRING AIRSOFT SERIES

- Easy operation with durable long life
- Great starter gun for beginners to the world of airsoft



AAKACZ162BZA
Silver Version Available

AAKACZ162AZA

SPRING GUN

AIRSOFT 6 mm (0.2g)

6 SPRING

SPIN	WEIGHT	LENGTH	ENERGY	VELOCITY	MATERIAL	BB CAPACITY	MAGAZINE
NON HOP-UP	360 g	215 mm	0.6 Joule Max	78 m/s Max	FULL PLASTIC	12 rds.	AAKACS160AZN

AAKACZ162BZA

SPRING GUN

AIRSOFT 6 mm (0.2g)

6 SPRING

SPIN	WEIGHT	LENGTH	ENERGY	VELOCITY	MATERIAL	BB CAPACITY	MAGAZINE
NON HOP-UP	360 g	200 mm	0.6 Joule Max	78 m/s Max	FULL PLASTIC	12 rds.	AAKACS160BZN

AAKACZ020AZA

SPRING GUN

AIRSOFT 6 mm (0.2g)

6 SPRING

SPIN	WEIGHT	LENGTH	ENERGY	VELOCITY	MATERIAL	BB CAPACITY	MAGAZINE
HOP-UP	620 g	235 mm	0.5 Joule Max	75 m/s Max	FULL PLASTIC	11 rds.	AAKACS020AZN



AAKACZ113AZA
Silver Version Available

AAKACZ113AZA

SPRING GUN

AIRSOFT 6 mm (0.2g)

6 SPRING

SPIN	WEIGHT	LENGTH	ENERGY	VELOCITY	MATERIAL	BB CAPACITY	MAGAZINE
HOP-UP	360 g	200 mm	0.6 Joule Max	78 m/s Max	FULL PLASTIC	12 rds.	AAKACS110AZN

AAKACZ113BZA

SPRING GUN

AIRSOFT 6 mm (0.2g)

6 SPRING

SPIN	WEIGHT	LENGTH	ENERGY	VELOCITY	MATERIAL	BB CAPACITY	MAGAZINE
HOP-UP	360 g	200 mm	0.6 Joule Max	78 m/s Max	FULL PLASTIC	12 rds.	AAKACS110BZN



AAKACZ260AZC
Silver Version Available

AAKACZ260AZC

SPRING GUN

AIRSOFT 6 mm (0.2g)

6 SPRING

SPIN	WEIGHT	LENGTH	ENERGY	VELOCITY	MATERIAL	BB CAPACITY	MAGAZINE
HOP-UP	750 g	235 mm	0.6 Joule Max	78 m/s Max	FULL PLASTIC	12 rds.	AAKACS260AZN

AAKACZ260BZC

SPRING GUN

AIRSOFT 6 mm (0.2g)

6 SPRING

SPIN	WEIGHT	LENGTH	ENERGY	VELOCITY	MATERIAL	BB CAPACITY	MAGAZINE
HOP-UP	750 g	235 mm	0.6 Joule Max	78 m/s Max	FULL PLASTIC	12 rds.	AAKACS260BZN



Rubberized Grip



4.5mm Steel BBs

.177 Airgun

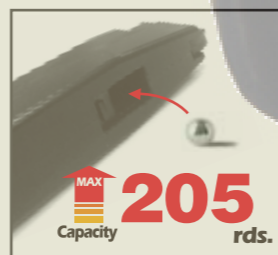

205 rds. Capacity

High Reservoir Magazine



Also available in metal slide

AAKAMZ030AZB

SPRING GUN

STEEL BB 4.5 (0.177")

SPRING

SPIN	WEIGHT	LENGTH	ENERGY	VELOCITY	MATERIAL	BB CAPACITY	MAGAZINE
NON HOP-UP	265 g	196 mm	0.6 Joule Max	57 m/s Max	FULL PLASTIC	16 rds.	AAKAMS030AZN

AAKAMZ110AZB

SPRING GUN

STEEL BB 4.5 (0.177")

SPRING

SPIN	WEIGHT	LENGTH	ENERGY	VELOCITY	MATERIAL	BB CAPACITY	MAGAZINE
NON HOP-UP	231 g	219 mm	0.6 Joule Max	63 m/s Max	FULL PLASTIC	16 rds.	AAKAMS110AZN

SPRING AIRGUN SERIES

- 1:1 scale
- Weaver rail compatible with standard flashlight or laser
- Rubber grip
- 205 rds BB reservoir with 15 rds per load

UNIVERSO SNIPER AIRSOFT

AAKAMZ460AZB

SPRING GUN

STEEL BB 4.5 (0.177")

SPRING

SPIN	WEIGHT	LENGTH	ENERGY	VELOCITY	MATERIAL	BB CAPACITY	MAGAZINE
NON HOP-UP	260 g	182 mm	0.5 Joule Max	55 m/s Max	PLASTIC SLIDE	15 rds.	AAKAMS460AZN

AAKAMZ461AZB

SPRING GUN

STEEL BB 4.5 (0.177")

SPRING

SPIN	WEIGHT	LENGTH	ENERGY	VELOCITY	MATERIAL	BB CAPACITY	MAGAZINE
NON HOP-UP	425 g	183 mm	0.6 Joule Max	60 m/s Max	METAL SLIDE	15 rds.	AAKAMS460AZN

SPRING AIRGUN SERIES

- Spring powered airgun
- Easy operation with durable long life
- High capacity magazine can load up to 70 BBs per magazine.
- Each loading is 16 rounds.



Spring Steel Gun



High Capacity Magazine



AAKACZ360AZC

SPRING GUN



SPIN	WEIGHT	LENGTH	ENERGY	VELOCITY	MATERIAL	BB CAPACITY	MAGAZINE
HOP-UP	1300 g	766 mm	0.5 Joule Max	71 m/s Max	FULL PLASTIC	18 rds.	AAKACS360AZT



AAKACZ370AZC

SPRING GUN

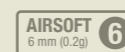

SPIN	WEIGHT	LENGTH	ENERGY	VELOCITY	MATERIAL	BB CAPACITY	MAGAZINE
HOP-UP	1600 g	766 mm	0.6 Joule Max	78 m/s Max	FULL PLASTIC	18 rds.	AAKACS360AZT



AAKACZ380AZC

SPRING GUN



SPIN	WEIGHT	LENGTH	ENERGY	VELOCITY	MATERIAL	BB CAPACITY	MAGAZINE
HOP-UP	1350 g	690 mm	0.6 Joule Max	78 m/s Max	FULL PLASTIC	18 rds.	AAKACS360AZT

MODEL M4 SERIES

- Dual spring loading system
- R.I.S hand guard
- High density composite material for extended durability
- Adjustable stock to fit all arm lengths
- High capacity 350 rounds reservoir in magazine

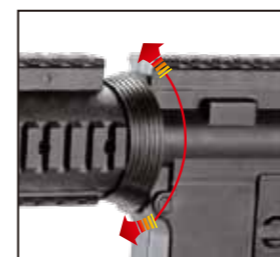

Adjustable Hop-up

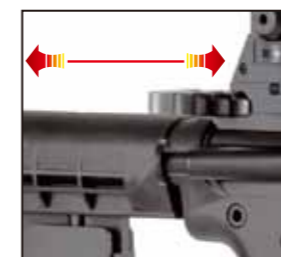

Classic Loading



Fast Reloading

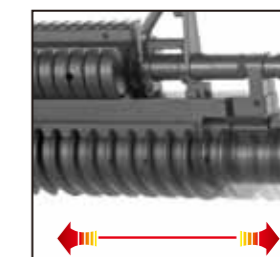

Fast Reloading

ACCESSORIES

AAKZZW006BZX
0.20g BB, 2000 Counts BOTTLE



AAKZZW006AZX
0.12g BB, 2000 Counts BOTTLE



AAKZZW033AZX
0.20g BB
750 Counts GRENADE shape



AAKZZW033BZX
0.20g BB
750 Counts GRENADE shape



AAKZZW080AZX
4.5 mm Steel BB
2000 counts / Grenade

AAKCPW680AZN
Pellet Revolver Clip



Shells are not included
AAKZZW150AZL
6 mm / 4.5 mm Speedloader

Pellet Rotary Clip
Assembly for Pellet gun

AAKCPW760AZN 4.5 mm

6X2 Pellet



AAKCPW460AZN 4.5 mm
8X2 Pellet

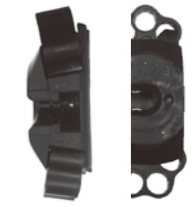

AAKCPW440AZN 4.5 mm
6X2 Pellet

AAKZZW046AZE
Gel Target



AAKZZW041AZE
Trap Target



AAKZZW047AZC
3-Bull's eye Multi-Function Auto Trap Target

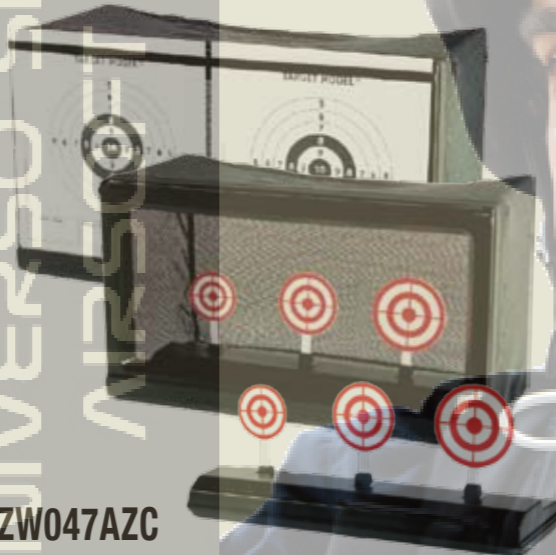

AAKMM771AZQ
4.5 mm 27 Steel rds.

AAKCCM771AZQ
6 mm 26 Plastic rds.

AAKCCM231A
6 mm 41+1 Plasti



AAKZZW134AZT
Holster Black



AAKZZW134BZT
Holster Desert Camo

AAKZZW134CZT

AAKZZW134DZU
Brown finish color



AAKZZW035AZT
Universal Rubber Grip



AAKZZW042AZX
12g C02

AAKZZW155AZT
Red Dot Laser

